

Northumbria Research Link

Citation: Vo, Thuc and Lee, Jaehong (2013) Vibration and buckling of thin-walled composite I-beams with arbitrary lay-ups under axial loads and end moments. *Mechanics of Advanced Materials and Structures*, 20 (8). pp. 652-665. ISSN 1537-6494

Published by: Taylor & Francis

URL: <http://dx.doi.org/10.1080/15376494.2011.643284>
<<http://dx.doi.org/10.1080/15376494.2011.643284>>

This version was downloaded from Northumbria Research Link:
<http://nrl.northumbria.ac.uk/13390/>

Northumbria University has developed Northumbria Research Link (NRL) to enable users to access the University's research output. Copyright © and moral rights for items on NRL are retained by the individual author(s) and/or other copyright owners. Single copies of full items can be reproduced, displayed or performed, and given to third parties in any format or medium for personal research or study, educational, or not-for-profit purposes without prior permission or charge, provided the authors, title and full bibliographic details are given, as well as a hyperlink and/or URL to the original metadata page. The content must not be changed in any way. Full items must not be sold commercially in any format or medium without formal permission of the copyright holder. The full policy is available online: <http://nrl.northumbria.ac.uk/policies.html>

This document may differ from the final, published version of the research and has been made available online in accordance with publisher policies. To read and/or cite from the published version of the research, please visit the publisher's website (a subscription may be required.)

www.northumbria.ac.uk/nrl



1 Vibration and buckling of thin-walled composite I-beams with arbitrary 2 lay-ups under axial loads and end moments

3 Thuc Phuong Vo* and Jaehong Lee†

4 *Department of Architectural Engineering, Sejong University*
5 *98 Kunja Dong, Kwangjin Ku, Seoul 143-747, Korea*

6 (Dated: April 21, 2011)

A finite element model with seven degrees of freedom per node is developed to study vibration and buckling of thin-walled composite I-beams with arbitrary lay-ups under constant axial loads and equal end moments. This model is based on the classical lamination theory, and accounts for all the structural coupling coming from material anisotropy. The governing differential equations are derived from the Hamilton's principle. Numerical results are obtained for thin-walled composite I-beams to investigate the effects of axial force, bending moment and fiber orientation on the buckling moments, natural frequencies and corresponding vibration mode shapes as well as axial-moment-frequency interaction curves.

7 Keywords: Thin-walled composite I-beams; fiber orientation; axial loads; end moments; axial-moment-frequency
8 interaction curves

9 1. INTRODUCTION

10 **Fiber-reinforced composite materials have been used over the past few decades in numerous types**
11 **of structures.** Composites have many desirable characteristics, such as high ratio of stiffness and strength to weight,
12 corrosion resistance and magnetic transparency. Thin-walled structural shapes made up of composite materials, which
13 are usually produced by pultrusion, are being increasingly used in many civil, mechanical and aerospace engineering
14 applications. However, it is well known that thin-walled composite structures might be under axial force and moment
15 simultaneously when used in above applications and are very susceptible to flexural-torsional/lateral buckling and
16 display complex vibrational behavior. **Therefore, the behavior and accurate prediction of their stability**
17 **and dynamic characteristics are of critical importance in the design of composite structures.**

18 The theory of thin-walled members made of isotropic materials was first developed by Vlasov [1] and Gjelsvik [2].
19 Since the early works of Bleich et al. [3] and Timoshenko et al. [4,5], **investigations into vibration and buckling**

*Present Address: Department of Engineering, University of Liverpool, Brownlow Street, Liverpool L69 3GQ, UK

†Professor, corresponding author. Tel.:+82-2-3408-3287; fax:+82-2-3408-3331

; Electronic address: jhlee@sejong.ac.kr

20 analyses of thin-walled beams subject simultaneously to axial loads and moments at both ends have
21 been carried out extensively and only few are mentioned herein. Analytical solutions for the stability
22 and vibrational behavior of thin-walled beams under combined loads have been performed by several
23 authors. Joshi and Suryanarayan [6,7] derived solutions for coupled flexural-torsional vibration and instability. They
24 found that the problem could be reduced to a beam-column problem with a zero moment, so that it was possible
25 to obtain simple algebraic expressions unifying numerical results for various boundary conditions. Pavlovic et al. [8]
26 obtained closed form analytical solutions for elastic stability problem of simply supported thin-walled beams subjected
27 to time-dependent stochastic axial loads and end moments. Mohri et al [9] proposed analytical solutions for lateral
28 buckling of simply supported bi-symmetric I-beams under combined bending and axial forces. Besides, the finite
29 element method has been widely used because of its versatility and efficiency. Mohri et al. [10] presented a higher-
30 order non shear deformable model to investigate the dynamic behavior of thin-walled open sections in the pre- and
31 post-buckling state. Voros [11] analyzed the free vibration and mode shapes of straight beams where the coupling
32 between the bending and torsion was induced by steady state lateral loads. As an alternative numerical method, the
33 boundary element method [12-14] was developed to solve the vibration and buckling problems of the homogeneous or
34 composite beams. The method overcomes the shortcoming of possible thin tube theory solution, which its utilization
35 had been proven to be prohibitive even in thin-walled homogeneous sections. Another effective approach for solving
36 stability and dynamic problems of thin-walled beams is to develop the dynamic stiffness matrix based on the solution
37 of simultaneous ordinary differential equations. By using the power series method, Leung [15-18], developed the exact
38 dynamic stiffness matrix including both the axial force, initial torque and bending moment for axial-lateral-torsional
39 vibration, axial-torsional and axial-moment buckling analysis of framed structures. For thin-walled composite beams,
40 with the presence of the additional coupling effects from material anisotropy, these members under axial force and
41 moment simultaneously exhibit strong coupling. Therefore, their elastic stability behavior becomes more complicated
42 than isotropic material even for doubly symmetric cross-section. **Although several authors have investigated**
43 **the free vibration characteristics of axially loaded thin-walled composite beams (Bank and Kao [19],**
44 **Banerjee et al. [20,21], Li et al. [22,23], Kaya and Ozgumus [24] and Kim et al. [25,26]), the existing**
45 **literature reveals that studies of vibration and/or buckling of thin-walled composite beams under**
46 **axial force and bending moment in a unitary manner are limited. Recently, Machado [27] derived**
47 **analytical solutions for the lateral stability analysis of cross-ply laminated thin-walled beams subjected**
48 **to combined axial and bending loads. Based on shear deformability, the theory was formulated in**

the context of large displacements and rotations, considering moderate bending rotations and large twist. However, composite was assumed to be made of symmetric balanced laminates and especially orthotropic laminates.

In previous works, Lee and Kim [28-30] focused separately the effect of axial loads on flexural-torsional buckling and bending loads on lateral buckling as well as free vibration of thin-walled composite I-beams with arbitrary lay-ups. This paper further investigates the effect of both axial loads and end moments on vibration and buckling of these beams. Axial-moment, load-frequency and axial-moment-frequency interaction curves with respect to the fiber angle change are presented. The duality among the buckling loads, buckling moments and natural frequencies is studied. This model is based on the classical lamination theory, and accounts for all the structural coupling coming from the material anisotropy. The governing differential equations for flexural-torsional coupled vibration and buckling are derived from the Hamilton's principle. A displacement-based one-dimensional finite element model with seven degrees of freedom per node is developed to solve the problem. Numerical results are obtained for thin-walled composite I-beams to investigate the effects of axial force, bending moment and fiber orientation on the buckling moments, natural frequencies and corresponding vibration mode shapes as well as interaction curves.

2. KINEMATICS

The theoretical developments presented in this paper require two sets of coordinate systems which are mutually interrelated. The first coordinate system is the orthogonal Cartesian coordinate system (x, y, z) , for which the x and y axes lie in the plane of the cross section and the z axis parallel to the longitudinal axis of the beam. The second coordinate system is the local plate coordinate (n, s, z) as shown in Fig. 1, wherein the n axis is normal to the middle surface of a plate element, the s axis is tangent to the middle surface and is directed along the contour line of the cross section. The (n, s, z) and (x, y, z) coordinate systems are related through an angle of orientation θ . As defined in Fig. 1 a point P , called the pole, is placed at an arbitrary point x_p, y_p . A line through P parallel to the z axis is called the pole axis.

To derive the analytical model for thin-walled open-section composite beams, the following assumptions are made:

1. The contour of the thin wall does not deform in its own plane.

- 76 2. The linear shear strain $\bar{\gamma}_{sz}$ of the middle surface is zero in each element.
- 77 3. The Kirchhoff-Love assumption in classical plate theory remains valid for laminated composite thin-walled
- 78 beams.
- 79 4. Each laminate is thin and perfectly bonded.
- 80 5. **Linear vibration and buckling analysis is examined.**
- 81 6. Local buckling is not considered.

82 According to assumption 1, the midsurface displacement components \bar{u}, \bar{v} at a point A in the contour coordinate

83 system can be expressed in terms of a displacements U, V of the pole P in the x, y directions, respectively, and the

84 rotation angle Φ about the pole axis,

$$\bar{u}(s, z) = U(z) \sin \theta(s) - V(z) \cos \theta(s) - \Phi(z)q(s) \quad (1a)$$

$$\bar{v}(s, z) = U(z) \cos \theta(s) + V(z) \sin \theta(s) + \Phi(z)r(s) \quad (1b)$$

85 These equations apply to the whole contour. The out-of-plane shell displacement \bar{w} can now be found from the

86 assumption 2. For each element of middle surface, the shear strain become

$$\bar{\gamma}_{sz} = \frac{\partial \bar{v}}{\partial z} + \frac{\partial \bar{w}}{\partial s} = 0 \quad (2)$$

87 Eq.(2) can be integrated with respect to s from the origin to an arbitrary point on the contour,

$$\bar{w}(s, z) = W(z) - U'(z)x(s) - V'(z)y(s) - \Phi'(z)\omega(s) \quad (3)$$

88 where differentiation with respect to the axial coordinate z is denoted by primes (''); **W is an integration function**

89 **that represents the average axial displacement of the beam in the z direction**; x and y are the coordinates

90 of the contour in the (x, y, z) coordinate system; and ω is the so-called sectorial coordinate or warping function given

91 by

$$\omega(s) = \int_{s_0}^s r(s)ds \quad (4)$$

92 The displacement components u, v, w representing the deformation of any generic point on the profile section are given

93 with respect to the midsurface displacements $\bar{u}, \bar{v}, \bar{w}$ by the assumption 3.

$$u(s, z, n) = \bar{u}(s, z) \quad (5a)$$

$$v(s, z, n) = \bar{v}(s, z) - n \frac{\partial \bar{u}(s, z)}{\partial s} \quad (5b)$$

$$w(s, z, n) = \bar{w}(s, z) - n \frac{\partial \bar{u}(s, z)}{\partial z} \quad (5c)$$

94 The non-zero strains associated with the small-displacement theory of elasticity are given by

$$\epsilon_z = \frac{\partial w}{\partial z} = \bar{\epsilon}_z + n\bar{\kappa}_z \quad (6a)$$

$$\gamma_{sz} = \frac{\partial v}{\partial z} + \frac{\partial w}{\partial s} = n\bar{\kappa}_{sz} \quad (6b)$$

95 where

$$\bar{\epsilon}_z = \frac{\partial \bar{w}}{\partial z} = \epsilon_z^\circ + x\kappa_y + y\kappa_x + \omega\kappa_\omega \quad (7a)$$

$$\bar{\kappa}_z = -\frac{\partial^2 \bar{u}}{\partial z^2} = \kappa_y \sin \theta - \kappa_x \cos \theta - \kappa_\omega q \quad (7b)$$

$$\bar{\kappa}_{sz} = -2\frac{\partial^2 \bar{u}}{\partial s \partial z} = \kappa_{sz} \quad (7c)$$

96 The resulting strains can be obtained from Eqs.(6) and (7) as

$$\epsilon_z = \epsilon_z^\circ + (x + n \sin \theta)\kappa_y + (y - n \cos \theta)\kappa_x + (\omega - nq)\kappa_\omega \quad (8a)$$

$$\gamma_{sz} = n\kappa_{sz} \quad (8b)$$

97 where $\epsilon_z^\circ, \kappa_x, \kappa_y, \kappa_\omega$ and κ_{sz} are axial strain, biaxial curvatures in the x and y direction, warping curvature with
98 respect to the shear center, and twisting curvature in the beam, respectively defined as

$$\epsilon_z^\circ = W' \quad (9a)$$

$$\kappa_x = -V'' \quad (9b)$$

$$\kappa_y = -U'' \quad (9c)$$

$$\kappa_\omega = -\Phi'' \quad (9d)$$

$$\kappa_{sz} = 2\Phi' \quad (9e)$$

99 3. VARIATIONAL FORMULATION

100 The total potential energy of the system can be stated as

$$\Pi = \mathcal{U} + \mathcal{V} \quad (10)$$

101 where \mathcal{U} is the strain energy

$$\mathcal{U} = \frac{1}{2} \int_v (\sigma_z \epsilon_z + \sigma_{sz} \gamma_{sz}) dv \quad (11)$$

102 After substituting Eq.(8) into Eq.(11)

$$\mathcal{U} = \frac{1}{2} \int_v \left\{ \sigma_z \left[\epsilon_z^0 + (x + n \sin \theta) \kappa_y + (y - n \cos \theta) \kappa_x + (\omega - nq) \kappa_\omega \right] + \sigma_{sz} n \kappa_{sz} \right\} dv \quad (12)$$

103 The variation of strain energy can be stated as

$$\delta \mathcal{U} = \int_0^l (N_z \delta \epsilon_z + M_y \delta \kappa_y + M_x \delta \kappa_x + M_\omega \delta \kappa_\omega + M_t \delta \kappa_{sz}) dz \quad (13)$$

104 where $N_z, M_x, M_y, M_\omega, M_t$ are axial force, bending moments in the x - and y -direction, warping moment (bimoment),
105 and torsional moment, respectively, defined by integrating over the cross-sectional area A as

$$N_z = \int_A \sigma_z ds dn \quad (14a)$$

$$M_y = \int_A \sigma_z (x + n \sin \theta) ds dn \quad (14b)$$

$$M_x = \int_A \sigma_z (y - n \cos \theta) ds dn \quad (14c)$$

$$M_\omega = \int_A \sigma_z (\omega - nq) ds dn \quad (14d)$$

$$M_t = \int_A \sigma_{sz} n ds dn \quad (14e)$$

106 The potential of in-plane loads \mathcal{V} due to transverse deflection

$$\mathcal{V} = \frac{1}{2} \int_v \bar{\sigma}_z^0 [(u')^2 + (v')^2] dv \quad (15)$$

107 where $\bar{\sigma}_z^0$ is the averaged constant in-plane edge axial stress of beams loaded initially by equal and opposite axial
108 forces P_0 and uniform bending moment applied about its major axis M_x^0 at two ends, defined by

$$\bar{\sigma}_z^0 = \frac{P_0}{A} - \frac{M_x^0 y}{I_x} \quad (16)$$

109 The variation of the potential of in-plane loads at the centroid is expressed by substituting the assumed displacement
110 field into Eq.(15) as

$$\begin{aligned} \delta \mathcal{V} = & \int_v \left(\frac{P_0}{A} - \frac{M_x^0 y}{I_x} \right) \left[U' \delta U' + V' \delta V' + (q^2 + r^2 + 2rn + n^2) \Phi' \delta \Phi' \right. \\ & \left. + (\Phi' \delta U' + U' \delta \Phi') [n \cos \theta - (y - y_p)] + (\Phi' \delta V' + V' \delta \Phi') [n \cos \theta + (x - x_p)] \right] dv \end{aligned} \quad (17)$$

111 The kinetic energy of the system is given by

$$\mathcal{T} = \frac{1}{2} \int_v \rho (\dot{u}^2 + \dot{v}^2 + \dot{w}^2) dv \quad (18)$$

112 where ρ is a density.

113 The variation of the kinetic energy is expressed by substituting the assumed displacement field into Eq.(18) as

$$\begin{aligned} \delta\mathcal{T} = & \int_v \rho \left\{ \dot{U}\delta\dot{U} + \dot{V}\delta\dot{V} + \dot{W}\delta\dot{W} + (q^2 + r^2 + 2rn + n^2)\dot{\Phi}\delta\dot{\Phi} + (\dot{\Phi}\delta\dot{U} + \dot{U}\delta\dot{\Phi}) \left[n \cos\theta - (y - y_p) \right] \right. \\ & \left. + (\dot{\Phi}\delta\dot{V} + \dot{V}\delta\dot{\Phi}) \left[n \cos\theta + (x - x_p) \right] \right\} dv \end{aligned} \quad (19)$$

114 In order to derive the equations of motion, Hamilton's principle is used

$$\delta \int_{t_1}^{t_2} (\mathcal{T} - \Pi) dt = 0 \quad (20)$$

115 Substituting Eqs.(13),(17) and (19) into Eq.(20), the following weak statement is obtained

$$\begin{aligned} 0 = & \int_{t_1}^{t_2} \int_0^l \left\{ m_0 \dot{W} \delta \dot{W} + \left[m_0 \dot{U} + (m_c + m_0 y_p) \dot{\Phi} \right] \delta \dot{U} + \left[m_0 \dot{V} + (m_s - m_0 x_p) \dot{\Phi} \right] \delta \dot{V} \right. \\ & + \left[(m_c + m_0 y_p) \dot{U} + (m_s - m_0 x_p) \dot{V} + (m_p + m_2 + 2m_\omega) \dot{\Phi} \right] \delta \dot{\Phi} \\ & - \left[P_0 \left[\delta U' (U' + \Phi' y_p) + \delta V' (V' - \Phi' x_p) + \delta \Phi' \left(\Phi' \frac{I_p}{A} + U' y_p - V' x_p \right) \right] - M_x^0 (\Phi \delta U'' + U'' \delta \Phi) \right] \\ & \left. - N_z \delta W' + M_y \delta U'' + M_x \delta V'' + M_\omega \delta \Phi'' - 2M_t \delta \Phi \right\} dz dt \end{aligned} \quad (21)$$

116 The expressions of inertia coefficients for thin-walled composite beams are given in Ref. [30].

117 4. CONSTITUTIVE EQUATIONS

118 The constitutive equations of a k^{th} orthotropic lamina in the laminate co-ordinate system of section are given by

$$\begin{Bmatrix} \sigma_z \\ \sigma_{sz} \end{Bmatrix}^k = \begin{bmatrix} \bar{Q}_{11}^* & \bar{Q}_{16}^* \\ \bar{Q}_{16}^* & \bar{Q}_{66}^* \end{bmatrix}^k \begin{Bmatrix} \epsilon_z \\ \gamma_{sz} \end{Bmatrix} \quad (22)$$

119 where \bar{Q}_{ij}^* are transformed reduced stiffnesses. The transformed reduced stiffnesses can be calculated from the
120 transformed stiffnesses based on the plane stress ($\sigma_s = 0$) and plane strain ($\epsilon_s = 0$) assumption. More detailed
121 explanation can be found in Ref. [31].

122 The constitutive equations for bar forces and bar strains are obtained by using Eqs.(8), (14) and (22)

$$\begin{Bmatrix} N_z \\ M_y \\ M_x \\ M_\omega \\ M_t \end{Bmatrix} = \begin{bmatrix} E_{11} & E_{12} & E_{13} & E_{14} & E_{15} \\ & E_{22} & E_{23} & E_{24} & E_{25} \\ & & E_{33} & E_{34} & E_{35} \\ & & & E_{44} & E_{45} \\ \text{sym.} & & & & E_{55} \end{bmatrix} \begin{Bmatrix} \epsilon_z^o \\ \kappa_y \\ \kappa_x \\ \kappa_\omega \\ \kappa_{sz} \end{Bmatrix} \quad (23)$$

123 where E_{ij} are stiffnesses of thin-walled composite beams and given in Ref. [30].

124 **5. GOVERNING EQUATIONS OF MOTION**

125 The governing equations of motion of the present study can be derived by integrating the derivatives of the varied
 126 quantities by parts and collecting the coefficients of δW , δU , δV and $\delta \Phi$

$$N'_z = m_0 \ddot{W} \quad (24a)$$

$$M''_y + P_0(U'' + \Phi'' y_p) + M_x^0 \Phi'' = m_0 \ddot{U} + (m_c + m_0 y_p) \ddot{\Phi} \quad (24b)$$

$$M''_x + P_0(V'' - \Phi'' x_p) = m_0 \ddot{V} + (m_s - m_0 x_p) \ddot{\Phi} \quad (24c)$$

$$\begin{aligned} M''_\omega + 2M'_t + P_0\left(\Phi'' \frac{I_p}{A} + U'' y_p - V'' x_p\right) + M_x^0 U'' &= (m_c + m_0 y_p) \ddot{U} \\ &+ (m_s - m_0 x_p) \ddot{V} \\ &+ (m_p + m_2 + 2m_\omega) \ddot{\Phi} \end{aligned} \quad (24d)$$

127 The natural boundary conditions are of the form

$$\delta W : N_z = P_0 \quad (25a)$$

$$\delta U : M'_y = M_y^0 \quad (25b)$$

$$\delta U' : M_y = M_y^0 \quad (25c)$$

$$\delta V : M'_x = M_x^0 \quad (25d)$$

$$\delta V' : M_x = M_x^0 \quad (25e)$$

$$\delta \Phi : M'_\omega + 2M_t = M_\omega^0 \quad (25f)$$

$$\delta \Phi' : M_\omega = M_\omega^0 \quad (25g)$$

128 where $P_0, M_y^0, M_y^0, M_x^0, M_x^0, M_\omega^0$ and M_ω^0 are prescribed values.

129 By substituting Eqs.(9) and (23) into Eq.(24), the explicit form of governing equations of motion can be expressed

130 with respect to the laminate stiffnesses E_{ij} as

$$E_{11}W'' - E_{12}U''' - E_{13}V''' - E_{14}\Phi''' + 2E_{15}\Phi'' = m_0\ddot{W} \quad (26a)$$

$$E_{12}W''' - E_{22}U^{iv} - E_{23}V^{iv} - E_{24}\Phi^{iv} + 2E_{25}\Phi''' + P_0(U'' + \Phi''y_p) + M_x^0\Phi'' = m_0\ddot{U} + (m_c + m_0y_p)\ddot{\Phi} \quad (26b)$$

$$E_{13}W''' - E_{23}U^{iv} - E_{33}V^{iv} - E_{34}\Phi^{iv} + 2E_{35}\Phi''' + P_0(V'' - \Phi''x_p) = m_0\ddot{V} + (m_s - m_0x_p)\ddot{\Phi} \quad (26c)$$

$$E_{14}W''' + 2E_{15}W'' - E_{24}U^{iv} - 2E_{25}U''' - E_{34}V^{iv} - 2E_{35}V''' - E_{44}\Phi^{iv} + 4E_{55}\Phi'' + P_0\left(\Phi''\frac{I_p}{A} + U''y_p - V''x_p\right) + M_x^0U'' = (m_c + m_0y_p)\ddot{U} + (m_s - m_0x_p)\ddot{V} + (m_p + m_2 + 2m_\omega)\ddot{\Phi} \quad (26d)$$

131 Eq.(26) is most general form for elastic stability of thin-walled composite beams with arbitrary lay-ups under
 132 constant axial loads and equal end moments and the dependent variables, W , U , V and Φ are fully coupled. If all
 133 the **coupling effects are neglected** and the cross section is symmetrical with respect to both x - and the y -axes,
 134 Eq.(26) can be simplified to the uncoupled differential equations as

$$(EA)_{com}W'' = \rho A\ddot{W} \quad (27a)$$

$$-(EI_y)_{com}U^{iv} + P_0U'' + M_x^0\Phi'' = \rho A\ddot{U} \quad (27b)$$

$$-(EI_x)_{com}V^{iv} + P_0V'' = \rho A\ddot{V} \quad (27c)$$

$$-(EI_\omega)_{com}\Phi^{iv} + \left[(GJ)_{com} + P_0\frac{I_p}{A}\right]\Phi'' + M_x^0U'' = \rho I_p\ddot{\Phi} \quad (27d)$$

135 From above equations, $(EA)_{com}$ represents axial rigidity, $(EI_x)_{com}$ and $(EI_y)_{com}$ represent flexural rigidities with
 136 respect to x - and y -axis, $(EI_\omega)_{com}$ represents warping rigidity, and $(GJ)_{com}$ represents torsional rigidity of thin-walled
 137 composite beams, respectively, written as

$$(EA)_{com} = E_{11} \quad (28a)$$

$$(EI_y)_{com} = E_{22} \quad (28b)$$

$$(EI_x)_{com} = E_{33} \quad (28c)$$

$$(EI_\omega)_{com} = E_{44} \quad (28d)$$

$$(GJ)_{com} = 4E_{55} \quad (28e)$$

138 **A. Flexural-torsional vibration under axial loads and equal end moments**

139 For simply supported beams with free warping, the overall displacements modes in bending and torsion are assumed

140 as

$$U(z, t) = U_0 \sin\left(\frac{n\pi z}{L}\right) \sin(\omega t) \quad (29a)$$

$$V(z, t) = V_0 \sin\left(\frac{n\pi z}{L}\right) \sin(\omega t) \quad (29b)$$

$$\Phi(z, t) = \Phi_0 \sin\left(\frac{n\pi z}{L}\right) \sin(\omega t) \quad (29c)$$

141 Substituting Eq.(29) into Eq.(27), after integrations and some reductions, the resulting flexural and torsional equations

142 of motion are obtained in compact form as

$$\omega_{x_n}^2 (1 - \bar{P}_{x_n}) - \omega_{xx_n}^2 = 0 \quad (30a)$$

$$A \left[\omega_{y_n}^2 (1 - \bar{P}_{y_n}) - \omega^2 \right] U_0 - \bar{M}_{x_n} \sqrt{AI_p} \omega_{y_n} \omega_{\theta_n} \Phi_0 = 0 \quad (30b)$$

$$-\bar{M}_{x_n} \sqrt{AI_p} \omega_{y_n} \omega_{\theta_n} U_0 + I_p \left[\omega_{\theta_n}^2 (1 - \bar{P}_{\theta_n}) - \omega^2 \right] \Phi_0 = 0 \quad (30c)$$

143 The flexural natural frequencies in the x -direction and bending moments are decoupled, while, the flexural natural

144 frequencies in the y -direction, torsional natural frequencies and bending moments are coupled.

$$\omega_{xx_n} = \omega_{x_n} \sqrt{1 - \bar{P}_{x_n}} \quad (31a)$$

$$\omega_{ya_n} = \sqrt{\frac{\omega_{y_n}^2 (1 - \bar{P}_{y_n}) + \omega_{\theta_n}^2 (1 - \bar{P}_{\theta_n})}{2}} - \sqrt{\left[\frac{\omega_{y_n}^2 (1 - \bar{P}_{y_n}) - \omega_{\theta_n}^2 (1 - \bar{P}_{\theta_n})}{2} \right]^2 + \bar{M}_n^2 \omega_{y_n}^2 \omega_{\theta_n}^2} \quad (31b)$$

$$\omega_{yb_n} = \sqrt{\frac{\omega_{y_n}^2 (1 - \bar{P}_{y_n}) + \omega_{\theta_n}^2 (1 - \bar{P}_{\theta_n})}{2}} + \sqrt{\left[\frac{\omega_{y_n}^2 (1 - \bar{P}_{y_n}) - \omega_{\theta_n}^2 (1 - \bar{P}_{\theta_n})}{2} \right]^2 + \bar{M}_n^2 \omega_{y_n}^2 \omega_{\theta_n}^2} \quad (31c)$$

145 in which $\bar{P}_{x_n}, \bar{P}_{y_n}, \bar{P}_{\theta_n}$ and \bar{M}_{x_n} are nondimensional axial force and moment parameters

$$\bar{P}_{x_n} = \frac{P_0}{P_{x_n}} \quad (32a)$$

$$\bar{P}_{y_n} = \frac{P_0}{P_{y_n}} \quad (32b)$$

$$\bar{P}_{\theta_n} = \frac{P_0}{P_{\theta_n}} \quad (32c)$$

$$\bar{M}_{x_n} = \frac{M_x^0}{M_{y\theta_n}} \quad (32d)$$

146 where P_{x_n} , P_{y_n} and P_{θ_n} are the flexural buckling loads in the x - and y -direction, and torsional buckling loads [4].

$$P_{x_n} = \frac{n^2 \pi^2 (EI_x)_{com}}{l^2} \quad (33a)$$

$$P_{y_n} = \frac{n^2 \pi^2 (EI_y)_{com}}{l^2} \quad (33b)$$

$$P_{\theta_n} = \frac{A}{I_p} \left[\frac{n^2 \pi^2 (EI_\omega)_{com}}{l^2} + (GJ)_{com} \right] \quad (33c)$$

147 and $M_{y\theta_n}$ is the buckling moments for pure bending [4].

$$M_{y\theta_n} = \sqrt{\frac{n^2 \pi^2 (EI_y)_{com}}{l^2} \left[\frac{n^2 \pi^2 (EI_\omega)_{com}}{l^2} + (GJ)_{com} \right]} \quad (34)$$

148 and ω_{x_n} , ω_{y_n} and ω_{θ_n} are the flexural natural frequencies in the x - and y -direction, and torsional natural frequencies
149 [5].

$$\omega_{x_n} = \frac{n^2 \pi^2}{l^2} \sqrt{\frac{(EI_x)_{com}}{\rho A}} \quad (35a)$$

$$\omega_{y_n} = \frac{n^2 \pi^2}{l^2} \sqrt{\frac{(EI_y)_{com}}{\rho A}} \quad (35b)$$

$$\omega_{\theta_n} = \frac{n\pi}{l} \sqrt{\frac{1}{\rho I_p} \left[\frac{n^2 \pi^2}{l^2} (EI_\omega)_{com} + (GJ)_{com} \right]} \quad (35c)$$

150 B. Flexural-torsional buckling under axial loads and equal end moments

151 By omitting the inertia terms, Eq.(27) becomes

$$(EA)_{com} W'' = 0 \quad (36a)$$

$$-(EI_y)_{com} U^{iv} + P_0 U'' + M_x^0 \Phi'' = 0 \quad (36b)$$

$$-(EI_x)_{com} V^{iv} + P_0 V'' = 0 \quad (36c)$$

$$-(EI_\omega)_{com} \Phi^{iv} + \left[(GJ)_{com} + P_0 \frac{I_p}{A} \right] \Phi'' + M_x^0 U''' = 0 \quad (36d)$$

152 It is well known that the flexural buckling loads in the x -direction are identified while the flexural buckling loads in
153 the y -direction, torsional buckling loads and buckling moments are coupled. The orthotropy solution for the critical
154 values of axial force P_0 and bending moment M_x^0 [4]

$$M_x^0 = r_p \sqrt{P_\theta P_y \left(1 - \frac{P_0}{P_y}\right) \left(1 - \frac{P_0}{P_\theta}\right)} \quad (37)$$

155 where P_x , P_y and P_θ are the critical flexural buckling load in the x - and y -direction, and the critical torsional buckling
156 load, can be obtained from Eq.(33).

157 6. FINITE ELEMENT FORMULATION

158 The present theory for thin-walled composite beams described in the previous section was implemented via a
 159 displacement based finite element method. The element has seven degrees of freedom at each node, three displacements
 160 W, U, V and three rotations U', V', Φ as well as one warping degree of freedom Φ' . The axial displacement W is
 161 interpolated using linear shape functions $\hat{\psi}_j$, whereas the lateral and vertical displacements U, V and axial rotation Φ
 162 are interpolated using Hermite-cubic shape functions ψ_j associated with node j and the nodal values, respectively.

$$W = \sum_{j=1}^2 w_j \hat{\psi}_j \quad (38a)$$

$$U = \sum_{j=1}^4 u_j \psi_j \quad (38b)$$

$$V = \sum_{j=1}^4 v_j \psi_j \quad (38c)$$

$$\Phi = \sum_{j=1}^4 \phi_j \psi_j \quad (38d)$$

163 Substituting these expressions into the weak statement in Eq.(21), the finite element model of a typical element
 164 can be expressed as the standard eigenvalue problem

$$([K] - P_0[G_1] - M_x^0[G_2] - \omega^2[M])\{\Delta\} = \{0\} \quad (39)$$

165 where $[K], [G_1], [G_2]$ and $[M]$ are the element stiffness matrix, the element geometric stiffness matrix due to axial
 166 force, bending moment and the element mass matrix, respectively. The explicit forms of them are given in Refs.
 167 [28-30].

168 In Eq.(39), $\{\Delta\}$ is the eigenvector of nodal displacements corresponding to an eigenvalue

$$\{\Delta\} = \{W \ U \ V \ \Phi\}^T \quad (40)$$

169 7. NUMERICAL EXAMPLES

170 For verification purpose, the buckling behavior and free vibration of a cantilever symmetrically laminated mono-
 171 symmetric I-beam with length $l = 1\text{m}$ under axial load at the centroid is performed. Following dimensions for the
 172 I-beam are used: the height, top and bottom flange widths are 50mm, 30mm and 50mm, respectively. The flanges and
 173 web are made of sixteen layers with each layer 0.13mm in thickness. All computations are carried out for the glass-
 174 epoxy materials with the following material properties: $E_1 = 53.78\text{GPa}$, $E_2 = 17.93\text{GPa}$, $G_{12} = 8.96\text{GPa}$, $\nu_{12} =$

175 0.25 , $\rho = 1968.9\text{kg/m}^3$. The critical buckling loads are evaluated and compared with numerical results of Kim and Shin
 176 [26], which is based on dynamic stiffness formulation and ABAQUS solutions in Table 1. Next, the flexural-torsional
 177 coupled vibration analysis of axially loaded cantilever beam is analyzed. The applied magnitude of axial force is given
 178 in Ref. [26], which corresponds to one half of buckling load of beam. The lowest four coupled natural frequencies
 179 with and without the axial force are presented in Table 2. Load-frequency interaction curves for fiber angles 0° , 30°
 180 and 60° is exhibited in Fig. 2. It reveals that the tension force has a stiffening effect while the compressive force has
 181 a softening effect on the natural frequencies. **The accuracy of the prediction from present model with Kim
 182 and Shin [26] can be seen in Tables 1 and 2, except for some natural frequencies in higher modes.
 183 However, maximum difference is small, nearly 2.5% and within the acceptable range.**

184 To illustrate the accuracy of this study further, a simply supported composite doubly symmetric I-beam with length
 185 $l = 5.0\text{m}$ under an eccentric load is analyzed. Lay-ups and material properties are the same with previous example
 186 except the geometry of I-section. Both of flanges width b and web height h are 50mm. The critical buckling loads of
 187 this beam under an axial compressive force acting at positions of $e = 0, h/4$ and $h/2$ from the centroid are calculated.
 188 The comparison of the results between the proposed finite element analysis and analytical approach by Kim et al. [32]
 189 is given in Table 3. The present solution again indicates good agreement with the analytical solution and ABAQUS
 190 results for all lamination schemes considered. Next, besides the eccentric load, this simply supported beam under
 191 an additional uniform bending moment simultaneously is performed to study effect of eccentricity on the buckling
 192 moments. The axial-moment interaction curves for various fiber angles are plotted in Fig. 3. The critical buckling
 193 moments for pure bending occur at about $M=42.28\text{Nm}$, 62.47Nm and 65.13Nm for fiber angles 60° , 30° and 0° ,
 194 respectively. It is clear that with the presence of the axial compressive force, the eccentricity decreases both buckling
 195 loads and moments. The relative difference of these results due to the eccentricity is significant and maximum at
 196 unidirectional fiber angle (Fig. 3 and Table 3).

197 In order to investigate the effect of axial force, bending moment, fiber orientation on the buckling moments, natural
 198 frequencies and corresponding vibration mode shapes as well as axial-moment-frequency interaction curves, a simply
 199 supported composite I-beam with length $l = 8\text{m}$ under axial force and uniform bending moment is considered. The
 200 geometry and stacking sequences of this simply supported beam are shown in Fig. 4, and the following engineering
 201 constants are used

$$E_1/E_2 = 25, G_{12}/E_2 = 0.6, \nu_{12} = 0.25 \quad (41)$$

For convenience, the following nondimensional axial force, bending moment and natural frequency are used

$$\bar{P} = \frac{P_0 l^2}{b_3^3 t E_2} \quad (42a)$$

$$\bar{M} = \frac{M_x^0 l}{b_3^3 t E_2} \quad (42b)$$

$$\bar{\omega} = \frac{\omega l^2}{b_3} \sqrt{\frac{\rho}{E_2}} \quad (42c)$$

Stacking sequences of the flanges and web are angle-ply laminates $[\theta/-\theta]$, (Fig. 4a). All the coupling stiffnesses are zero, but E_{15}, E_{35} do not vanish due to unsymmetric lay-up of the flanges and web. Effect of axial force on the critical buckling moments (\bar{M}_{cr}) is shown in Table 4. The critical buckling loads and the critical buckling moments without axial force agree completely with those of previous papers [28,29]. In Table 5, with the presence of bending moment, the lowest four natural frequencies with and without the effect of axial force by the finite element analysis are compared to those of the orthotropy solution, which neglects the coupling effects of E_{15}, E_{35} from Eqs.(31a)-(31c). It can be seen that the change in the critical buckling moments and natural frequencies due to axial force is noticeable for all fiber angles. The results diminish when the axial force changes from tensile to compressive, as expected. This demonstrates again the fact that a tensile force stiffens the beam and a compressive force softens the beam. For unidirectional fiber direction, the results by the finite element analysis exactly correspond to those by the orthotropy solution (Tables 4 and 5). At this fiber angle, the lowest four natural frequencies are the first, second and third flexural-torsional coupled modes and the first flexural mode in x -direction, respectively. As fiber angle changes, **this order changes a bit**. It can be explained by the typical normal mode shapes corresponding to the lowest four natural frequencies with fiber angle $\theta = 30^\circ$ for the case ($\bar{P} = 0.5\bar{P}_{cr}$, $\bar{M} = 0.5\bar{M}_{cr}$) in Fig. 5. Relative measures of flexural displacements, torsional rotation show that when the beam is vibrating at the natural frequency belonging to the first and second mode exhibits doubly coupled vibrations (flexural mode in y -direction and torsional mode), whereas, third and fourth mode display triply coupled vibrations (flexural mode in the x -, y -direction and torsional mode). Due to the small coupling stiffnesses E_{15}, E_{35} , the results by the finite element analysis and orthotropy solution show slight discrepancy in the range $\theta \in [15^\circ - 60^\circ]$. However, as fiber angle increases, the coupling effects from material anisotropy become negligible. Therefore, the orthotropy solution and the finite element analysis are nearly identical. In order to investigate the effects of bending moment on the critical buckling loads and natural frequencies, the axial-moment and moment-frequency interaction curves for the fiber angles $\theta = 30^\circ$ and 60° of two solutions are plotted in Figs. 6-8. All of the interaction curves are symmetric with respect to the $\bar{M} = 0$ axis. **The moment at buckling increase from zero as the axial compressive force decreases from the buckling**

227 **load to the buckling moment when $\bar{P} = 0$, as shown in Fig. 6. Further increases take place after axial**
 228 **force becomes negative (tensile).** Characteristic of axial-moment and moment-frequency interaction curves is
 229 that the value of the bending moment for which the axial force or natural frequency vanishes constitutes the buckling
 230 moment. For example, for $\theta = 30^\circ$ (Fig. 7), when the beam is under an axial compressive force ($\bar{P} = 0.5\bar{P}_{cr}$), the
 231 first buckling moment occurs at $\bar{M} = 2.36 \times 10^{-2}$, which agrees completely with value from Table 4. As a result, the
 232 lowest branch is disappeared when \bar{M} is slightly over this value. As the bending moment increases, two interaction
 233 curves ($\omega_2 - M_2$) and ($\omega_3 - M_3$) intersect at $\bar{M} = 5.37 \times 10^{-2}$, thus, after this value, vibration mode 2 and 3 change
 234 each other. The second branch will also be disappeared when \bar{M} is slightly over 8.44×10^{-2} , which is corresponding
 235 to the second buckling moment. Fig. 9 shows a comprehensive three dimensional axial-moment-frequency interaction
 236 diagram. Two groups of curves are observed. The small group is for $\theta = 60^\circ$ and the larger group is for $\theta = 45^\circ$. It
 237 is clear that moment-frequency interaction curves become smaller as the axial compressive force increases. Finally,
 238 these curves vanish at about $\bar{P} = 0.25$ and 0.45 for fiber angle $\theta = 60^\circ$ and 45° , respectively, which implies that at
 239 these loads, the critical bucklings occur as a degenerated case of natural vibration at zero frequency and bending
 240 moment at zero value.

241 The next example is the same as before except that in this case, the bottom flange is angle-ply laminates $[\theta/-\theta]$,
 242 while the top flange and web laminates are unidirectional, (Fig. 4b). Major effects of axial force and bending moment
 243 on the critical buckling moments and natural frequencies are again seen Tables 6 and 7. As the fiber angle changes, the
 244 orthotropy solution and the finite element analysis solution show discrepancy indicating the coupling effects become
 245 significant. That is, the orthotropy solution is no longer valid for unsymmetrically laminated beams, and triply
 246 flexural-torsional coupled vibration and buckling should be considered even for bisymmetric thin-walled composite
 247 beams. The effect of axial force on the critical buckling moments with the fiber angles 30° and 60° is plotted in Fig.
 248 10. When the axial force is compressive, this beam has two different critical buckling moments. The higher one of
 249 these is positive and occurs when the moment causes compression in the top flange, while the lower one is negative,
 250 corresponding to a reversal in the sense of the moment which causes tension in the top flange. On the other hand,
 251 when the axial force is tensile, the higher buckling moment is negative and lower one is positive. Beside, it tends to
 252 stabilize the beam, and the critical buckling moments are increased, as expected. The lowest three moment-frequency
 253 interaction curves with the fiber angle $\theta = 60^\circ$ for two cases ($\bar{P} = -0.5\bar{P}_{cr}$) and ($\bar{P} = 0.5\bar{P}_{cr}$) are displayed in Figs.
 254 11 and 12. With the increase of bending moment, after the first and third natural frequencies increase and reach
 255 local maximum values, they decrease. The increase and decrease become steeper when bending moments are close

256 to buckling moments. It is from Figs. 10-12 that highlights the effects of coupling on the vibration and buckling of
257 thin-walled composite beam under constant axial loads and equal end moments. All of the symmetric axial-moment
258 and moment-frequency interaction curves are no longer visible. This response is never seen in bisymmetric thin-walled
259 isotropic beams because the coupling terms are not present. It is similar to the behavior of monosymmetric beams,
260 which implies that due to coupling effects when thin-walled composite beams under axial force and bending moment,
261 for each value of axial force or natural frequency always corresponding to two unequal values of buckling moment.
262 Figs. 10-12 also explain the duality among buckling moment, critical buckling load and natural frequency.

263 8. CONCLUDING REMARKS

264 Vibration and buckling of **thin-walled composite I-beams** with arbitrary lay-ups under axial loads and end
265 moments is presented. This model is capable of predicting accurately the buckling moments, natural frequencies
266 and corresponding vibration mode shapes as well as axial-moment-frequency interaction curves. To formulate the
267 problem, a one-dimensional displacement-based finite element method with **seven degrees of freedom** per node is
268 developed. All of the possible vibration mode shapes including the flexural mode in the x - and y -direction and the
269 torsional mode, and fully flexural-torsional coupled mode are included in the analysis. The present model is found to
270 be appropriate and efficient in analyzing vibration and buckling problem of **thin-walled composite I-beams** under
271 constant axial loads and equal end moments.

272 Acknowledgments

273 This research was supported by Basic Research Laboratory Program of the National Research Foundation of Korea
274 (NRF) funded by the Ministry of Education, Science and Technology through NRF2010-0019373, and by Korea
275 Ministry of Knowledge Economy under the national HRD support program for convergence information technology
276 supervised by National IT Industry Promotion Agency through NIPA-2010-C6150-1001-0013.

277 References

- 278 [1] V. Z. Vlasov, Thin Walled Elastic Beams, Israel Program for Scientific Transactions, Jerusalem, 1961.
279 [2] A. Gjelsvik, The theory of thin walled bars, Wiley, New York, 1981.
280 [3] F. Bleich, L. Ramsey, H. Bleich, Buckling strength of metal structures, McGraw-Hill, New York, 1952.
281 [4] S. Timoshenko, J. M. Gere, Theory of elastic stability, McGraw-Hill, New York, 1961.

- 282 [5] S. Timoshenko, D. H. Young, W. J. R. Weaver, *Vibration problems in engineering*, John Wiley & Sons, New York, 1974.
- 283 [6] A. Joshi, S. Suryanarayan, A unified solution for various boundary conditions for the coupled flexural-torsional instability
284 of closed thin-walled beam-columns, *Int J Solids Struct* 20 (2) (1984) 167 – 178.
- 285 [7] A. Joshi, S. Suryanarayan, Unified analytical solution for various boundary conditions for the coupled flexural-torsional
286 vibration of beams subjected to axial loads and end moments, *J Sound Vib* 129 (2) (1989) 313 – 326.
- 287 [8] R. Pavlovic, P. Kozic, P. Rajkovic, I. Pavlovic, Dynamic stability of a thin-walled beam subjected to axial loads and end
288 moments, *J Sound Vib* 301 (3-5) (2007) 690 – 700.
- 289 [9] F. Mohri, C. Bouzerira, M. Potier-Ferry, Lateral buckling of thin-walled beam-column elements under combined axial and
290 bending loads, *Thin-Walled Struct* 46 (3) (2008) 290 – 302.
- 291 [10] F. Mohri, L. Azrar, M. Potier-Ferry, Vibration analysis of buckled thin-walled beams with open sections, *J Sound Vib*
292 275 (1-2) (2004) 434 – 446.
- 293 [11] G. M. Voros, On coupled bending-torsional vibrations of beams with initial loads, *Mech Res Commun* 36 (5) (2009) 603 –
294 611.
- 295 [12] E. J. Sapountzakis, G. C. Tsiatas, Flexural-torsional Vibrations of Beams by BEM, *Comput Mech* 39 (4) (2007) 409–417.
- 296 [13] E. J. Sapountzakis, G. C. Tsiatas, Flexural - torsional buckling and vibration analysis of composite beams, *Comput Mater*
297 *Con* 6(2) (2007) 103–115.
- 298 [14] E. J. Sapountzakis, J. Dourakopoulos, Lateral buckling analysis of beams of arbitrary cross section by BEM, *Comput Mech*
299 45 (1) (2009) 11–21.
- 300 [15] A. Y. T. Leung, Dynamic stiffness analysis for axial-lateral-torsional vibration, *Dynamical Systems: An International*
301 *Journal* 8 (1) (1993) 19 – 30.
- 302 [16] A. Y. T. Leung, Exact dynamic stiffness for axial-torsional buckling of structural frames, *Thin-Walled Struct* 46 (1) (2008)
303 1 – 10.
- 304 [17] A. Y. T. Leung, Dynamic axial-moment buckling of linear beam systems by power series stiffness, *J Eng Mech* 135 (8)
305 (2009) 852–861.
- 306 [18] A. Y. T. Leung, Nonconservative dynamic axial-torsional buckling of structural frames using power series, *Int J Mech Sci*
307 *In* 51 (11-12) (2009) 807–815.
- 308 [19] L. C. Bank, C. Kao, Dynamic Response of Thin-Walled Composite Material Timoshenko Beams, *J Energ Resour* 112 (2)
309 (1990) 149–154.
- 310 [20] J. R. Banerjee, F. W. Williams, Exact dynamic stiffness matrix for composite Timoshenko beams with applications, *J*
311 *Sound Vib* 194 (4) (1996) 573 – 585.
- 312 [21] J. R. Banerjee, Free vibration of axially loaded composite Timoshenko beams using the dynamic stiffness matrix method,
313 *Comput Struct* 69 (2) (1998) 197 – 208.

- 314 [22] J. Li, R. Shen, H. Hua, J. Xianding, Bending-torsional coupled dynamic response of axially loaded composite Timosenko
315 thin-walled beam with closed cross-section, *Compos Struct* 64 (1) (2004) 23 – 35.
- 316 [23] J. Li, G. Wu, R. Shen, H. Hua, Stochastic bending-torsion coupled response of axially loaded slender composite-thin-walled
317 beams with closed cross-sections, *Int J Mech Sci* 47 (1) (2005) 134 – 155.
- 318 [24] M. Kaya, O. O. Ozgumus, Flexural-torsional-coupled vibration analysis of axially loaded closed-section composite Timo-
319 shenko beam by using DTM, *J Sound Vib* 306 (3-5) (2007) 495 – 506.
- 320 [25] N. I. Kim, D. K. Shin, Y. S. Park, Dynamic stiffness matrix of thin-walled composite I-beam with symmetric and arbitrary
321 laminations, *J Sound Vib* 318 (1-2) (2008) 364 – 388.
- 322 [26] N. I. Kim, D. K. Shin, Dynamic stiffness matrix for flexural-torsional, lateral buckling and free vibration analyses of
323 mono-symmetric thin-walled composite beams, *Int J Struct Stab Dy* 9 (3) (2009) 411–436.
- 324 [27] Machado, S. P. Interaction of combined loads on the lateral stability of thin-walled composite beams *Eng Struct* 32 (11)
325 (2010) 3516–3527
- 326 [28] J. Lee, S. E. Kim, Flexural-torsional buckling of thin-walled I-section composites, *Comput Struct* 79 (10) (2001) 987 – 995.
- 327 [29] J. Lee, S. E. Kim, K. Hong, Lateral buckling of I-section composite beams, *Eng Struct* 24 (7) (2002) 955 – 964.
- 328 [30] J. Lee, S. E. Kim, Free vibration of thin-walled composite beams with I-shaped cross-sections, *Compos Struct* 55 (2) (2002)
329 205 – 215.
- 330 [31] R. M. Jones, *Mechanics of Composite Materials*, Taylor & Francis, 1999.
- 331 [32] N. I. Kim, D. K. Shin, M. Y. Kim, Improved flexural-torsional stability analysis of thin-walled composite beam and exact
332 stiffness matrix, *Int J Mech Sci* 49 (8) (2007) 950 – 969.

333 CAPTIONS OF TABLES

334 Table 1: Critical buckling loads (N) of a cantilever mono-symmetric composite I-beam with symmetric angle-ply
 335 laminates $[\pm\theta]_{4s}$ in the flanges and web.

336 Table 2: Natural frequencies (Hz) of a cantilever mono-symmetric composite I-beam with symmetric angle-ply
 337 laminates $[\pm\theta]_{4s}$ in the flanges and web under constant axial forces at the centroid ($(\)$: natural frequency with an
 338 axial compressive force, $[\]$: natural frequency with an axial tensile force).

339 Table 3: Effect of eccentricity on critical buckling loads (N) of a simply supported composite I-beam with symmetric
 340 angle-ply laminates $[\pm\theta]_{4s}$ in the flanges and web.

341 Table 4: Effect of axial force on the critical buckling moments $\overline{M}_{cr}(\times 10^{-2})$ of a simply supported composite beam
 342 with respect to the fiber angle change in the flanges and web.

343 Table 5: Effect of axial force and bending moment on the first four natural frequencies of a simply supported
 344 composite beam with respect to the fiber angle change in the flanges and web.

345 Table 6: Effect of axial force on the critical buckling moments $\overline{M}_{cr}(\times 10^{-2})$ of a simply supported composite beam
 346 with respect to the fiber angle change in the bottom flange.

347 Table 7: Effect of axial force and bending moment on the first four natural frequencies of a simply supported
 348 composite beam with respect to the fiber angle change in the bottom flange.

349 CAPTIONS OF FIGURES

350 Figure 1: Definition of coordinates in thin-walled open-section composite beams.

351 Figure 2: Effect of axial force on the fundamental natural frequency with the fiber angles 0° , 30° and 60° in the
352 flanges and web of a cantilever mono-symmetric composite I-beam.

353 Figure 3: Effect of eccentricity and axial compressive force on the critical buckling moments with the fiber angles
354 0° , 30° and 60° in the flanges and web of a simply supported composite beam.

355 Figure 4: Geometry and stacking sequences of a simply supported I-beam under axial load and uniform bending.

356 Figure 5: The first four normal mode shapes of the flexural and torsional components with the fiber angle 30° in the
357 flanges and web of a simply supported composite beam under an axial compressive force ($\bar{P} = 0.5\bar{P}_{cr}$) and bending
358 moment ($\bar{M} = 0.5\bar{M}_{cr}$).

359 Figure 6: Effect of axial force on the critical buckling moments with the fiber angles 30° and 60° in the flanges and
360 web of a simply supported composite beam.

361 Figure 7: Effect of bending moment on the first three natural frequencies with the fiber angle 30° in the bottom
362 flange of a simply supported composite beam under an axial compressive force ($\bar{P} = 0.5\bar{P}_{cr}$).

363 Figure 8: Effect of bending moment on the first three natural frequencies with the fiber angle 60° in the bottom
364 flange of a simply supported composite beam under an axial compressive force ($\bar{P} = 0.5\bar{P}_{cr}$).

365 Figure 9: Three dimensional interaction diagram of the fundamental natural frequency, bending moment and axial
366 compressive force with the fiber angle 45° and 60° in the flanges and web of a simply supported composite beam.

367 Figure 10: Effect of axial force on the critical buckling moments with the fiber angles 30° and 60° in the bottom
368 flange of a simply supported composite beam.

369 Figure 11: Effect of bending moment on the first three natural frequencies with the fiber angle 60° in the bottom
370 flange of a simply supported composite beam under an axial tensile force ($\bar{P} = -0.5\bar{P}_{cr}$).

371 Figure 12: Effect of bending moment on the first three natural frequencies with the fiber angle 60° in the bottom
372 flange of a simply supported composite beam under an axial compressive force ($\bar{P} = 0.5\bar{P}_{cr}$).

TABLE 1 Critical bucking loads (N) of a cantilever mono-symmetric composite I-beam with symmetric angle-ply laminates $[\pm\theta]_{4s}$ in the flanges and web.

Lay-ups	Kim and Shin [26]		Present
	ABAQUS	No shear	
$[0]_{16}$	2969.7	2998.1	2998.2
$[15/-15]_{4s}$	2790.9	2813.8	2806.3
$[30/-30]_{4s}$	2190.6	2201.1	2186.8
$[45/-45]_{4s}$	1558.9	1562.4	1548.0
$[60/-60]_{4s}$	1239.4	1241.5	1229.6
$[75/-75]_{4s}$	1132.2	1134.5	1128.6

TABLE 2 Natural frequencies (Hz) of a cantilever mono-symmetric composite I-beam with symmetric angle-ply laminates $[\pm\theta]_{4s}$ in the flanges and web under constant axial forces at the centroid ($()$: natural frequency with an axial compressive force, $[]$: natural frequency with an axial tensile force).

Mode	Stacking sequences and axial force											
	$[0]_{16}$		$[15/-15]_{4s}$		$[30/-30]_{4s}$		$[45/-45]_{4s}$		$[60/-60]_{4s}$		$[75/-75]_{4s}$	
	P=1499.05 N		P=1406.90 N		P=1100.55 N		P=781.20 N		P=620.75 N		P=567.25 N	
	Ref. [26]	Present	Ref. [26]	Present	Ref. [26]	Present	Ref. [26]	Present	Ref. [26]	Present	Ref. [26]	Present
1	(19.087)	(19.090)	(18.505)	(18.460)	(16.401)	(16.295)	(13.841)	(13.710)	(12.342)	(12.220)	(11.791)	(11.729)
	26.295	26.298	25.508	25.478	22.641	22.561	19.130	19.024	17.063	16.963	16.294	16.244
	[31.498]	[31.501]	[30.568]	[30.542]	[27.162]	[27.087]	[22.970]	[22.866]	[20.492]	[20.393]	[19.561]	[19.512]
2	(43.267)	(43.267)	(44.524)	(44.388)	(46.335)	(45.155)	(40.135)	(40.178)	(35.692)	(35.730)	(34.273)	(34.310)
	46.472	46.470	47.346	47.222	48.325	47.210	42.243	42.287	37.575	37.615	36.066	36.104
	[49.414]	[49.412]	[49.969]	[49.853]	[50.213]	[49.154]	[44.224]	[44.269]	[39.345]	[39.385]	[37.751]	[37.790]
3	(59.242)	(59.304)	(56.205)	(56.265)	(48.304)	(48.355)	(45.879)	(42.790)	(42.648)	(39.156)	(37.990)	(36.481)
	61.988	62.052	58.920	58.982	50.772	50.825	47.267	44.287	43.831	40.451	39.210	37.756
	[64.586]	[64.653]	[61.484]	[61.547]	[53.096]	[53.150]	[48.593]	[45.715]	[44.963]	[41.688]	[40.374]	[38.973]
4	(129.73)	(129.809)	(127.28)	(127.084)	(118.02)	(116.806)	(104.11)	(101.808)	(93.778)	(91.419)	(88.027)	(86.926)
	138.17	138.251	135.30	135.126	124.68	123.563	109.44	107.273	98.472	96.250	92.605	91.573
	[146.02]	[146.105]	[142.77]	[142.619]	[130.94]	[129.897]	[114.47]	[112.423]	[102.92]	[100.808]	[96.927]	[95.954]

TABLE 3 Effect of eccentricity on critical buckling loads (N) of a simply supported composite I-beam with symmetric angle-ply laminates $[\pm\theta]_{4s}$ in the flanges and web.

Lay-ups	$e = 0$	$e = h/4$		Present	$e = h/2$
		Kim et al.[32]			
		ABAQUS	No shear		
$[0]_{16}$	920.8			890.3	818.6
$[15/-15]_{4s}$	832.0	809.2	810.7	810.5	757.5
$[30/-30]_{4s}$	617.8	608.1	608.7	608.0	582.2
$[45/-45]_{4s}$	427.6	423.5	423.7	422.9	410.0
$[60/-60]_{4s}$	338.4	335.5	335.6	334.9	325.3
$[75/-75]_{4s}$	311.7	308.6	308.6	308.3	298.8

TABLE 4 Effect of axial force on the critical buckling moments $\bar{M}_{cr}(\times 10^{-2})$ of a simply supported composite beam with respect to the fiber angle change in the flanges and web.

Fiber angle	Buckling loads (\bar{P}_{cr})	$\bar{P} = 0.5\bar{P}_{cr}$ (compression)		$\bar{P}=0$ (no axial force)		$\bar{P} = -0.5\bar{P}_{cr}$ (tension)	
		Present	Orthotropy	Present	Orthotropy	Present	Orthotropy
0	5.153	4.451	4.451	7.370	7.370	10.175	10.175
15	4.026	4.348	4.851	6.842	7.486	9.151	9.875
30	1.404	2.358	2.733	3.496	4.004	4.472	5.068
45	0.454	1.105	1.192	1.599	1.720	2.003	2.147
60	0.255	0.701	0.713	1.009	1.026	1.258	1.278
75	0.213	0.564	0.565	0.813	0.814	1.014	1.016
90	0.206	0.528	0.528	0.763	0.763	0.953	0.953

TABLE 5 Effect of axial force and bending moment on the first four natural frequencies of a simply supported composite beam with respect to the fiber angle change in the flanges and web.

Fiber angle	Axial force & moment	Present				Orthotropy			
		ω_1	ω_2	ω_3	ω_4	ω_{ya_1}	ω_{yb_1}	ω_{ya_2}	ω_{xx_1}
0		2.914	6.204	18.657	19.830	2.914	6.204	18.657	19.830
30	$\bar{P} = 0.5\bar{P}_{cr}$	1.591	6.010	9.655	10.225	1.667	6.936	9.732	10.352
60	$\bar{M} = 0.5\bar{M}_{cr}$	0.684	4.128	4.158	4.408	0.688	4.231	4.132	4.415
90		0.614	3.493	3.710	3.966	0.614	3.493	3.710	3.966
0		3.980	7.522	19.654	20.148	3.980	7.522	19.654	20.148
30	$\bar{P} = 0$	2.224	6.377	10.069	10.521	2.335	7.237	10.290	10.518
60	$\bar{M} = 0.5\bar{M}_{cr}$	0.963	4.254	4.345	4.486	0.969	4.324	4.357	4.486
90		0.864	3.584	3.911	4.030	0.864	3.584	3.911	4.030
0		4.769	8.666	20.461	20.518	4.769	8.666	20.518	20.461
30	$\bar{P} = -0.5\bar{P}_{cr}$	2.694	6.732	10.353	10.899	2.832	7.532	10.802	10.681
60	$\bar{M} = 0.5\bar{M}_{cr}$	1.175	4.348	4.515	4.595	1.182	4.415	4.568	4.555
90		1.053	3.675	4.092	4.098	1.053	3.675	4.098	4.092

TABLE 6 Effect of axial force on the critical buckling moments $\bar{M}_{cr}(\times 10^{-2})$ of a simply supported composite beam with respect to the fiber angle change in the bottom flange.

Fiber angle	Buckling loads (\bar{P}_{cr})	$\bar{P} = 0.5\bar{P}_{cr}$ (compression)		$\bar{P}=0$ (no axial force)		$\bar{P} = -0.5\bar{P}_{cr}$ (tension)	
		Present	Orthotropy	Present	Orthotropy	Present	Orthotropy
0	5.153	4.451	4.451	7.370	7.370	10.175	10.175
15	4.565	4.042	4.366	6.883	7.054	9.233	9.604
30	2.771	2.498	3.201	4.895	5.007	6.071	6.789
45	1.631	1.819	2.388	3.597	3.614	4.265	4.831
60	1.259	1.621	2.087	3.117	3.119	3.655	4.121
75	1.140	1.553	1.982	2.948	2.948	3.448	3.877
90	1.112	1.536	1.955	2.905	2.905	3.397	3.815

TABLE 7 Effect of axial force and bending moment on the first four natural frequencies of a simply supported composite beam with respect to the fiber angle change in the bottom flange.

Fiber angle	Axial force & moment	Present				Orthotropy			
		ω_1	ω_2	ω_3	ω_4	ω_{ya_1}	ω_{yb_1}	ω_{ya_2}	ω_{xx_1}
0		2.914	6.204	18.657	19.830	2.914	6.204	18.657	19.830
30	$\bar{P} = 0.5\bar{P}_{cr}$	3.049	4.108	12.652	16.205	2.629	4.355	13.595	16.240
60	$\bar{M} = 0.5\bar{M}_{cr}$	2.050	3.655	5.990	12.317	1.836	3.353	6.019	14.596
90		1.895	3.674	5.450	11.146	1.695	3.360	5.453	14.523
0		3.980	7.522	19.654	20.148	3.980	7.522	19.654	20.148
30	$\bar{P} = 0$	3.672	4.772	14.120	16.429	3.102	5.471	14.034	16.449
60	$\bar{M} = 0.5\bar{M}_{cr}$	2.650	3.712	7.014	13.492	2.148	4.027	6.850	14.703
90		2.448	3.721	6.422	12.270	2.021	3.945	6.268	14.617
0		4.769	8.666	20.461	20.518	4.769	8.666	20.518	20.461
30	$\bar{P} = -0.5\bar{P}_{cr}$	4.165	5.551	15.214	16.677	3.781	6.240	14.697	16.656
60	$\bar{M} = 0.5\bar{M}_{cr}$	3.068	4.066	7.855	14.513	2.639	4.481	7.647	14.808
90		2.857	4.022	7.226	13.254	2.487	4.353	7.040	14.710

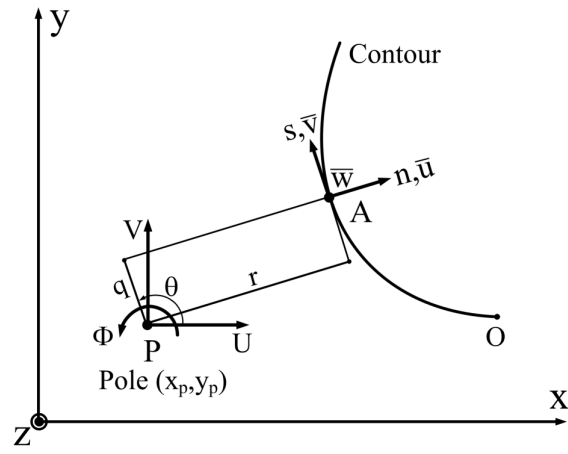

FIG. 1 Definition of coordinates in thin-walled open-section composite beams.

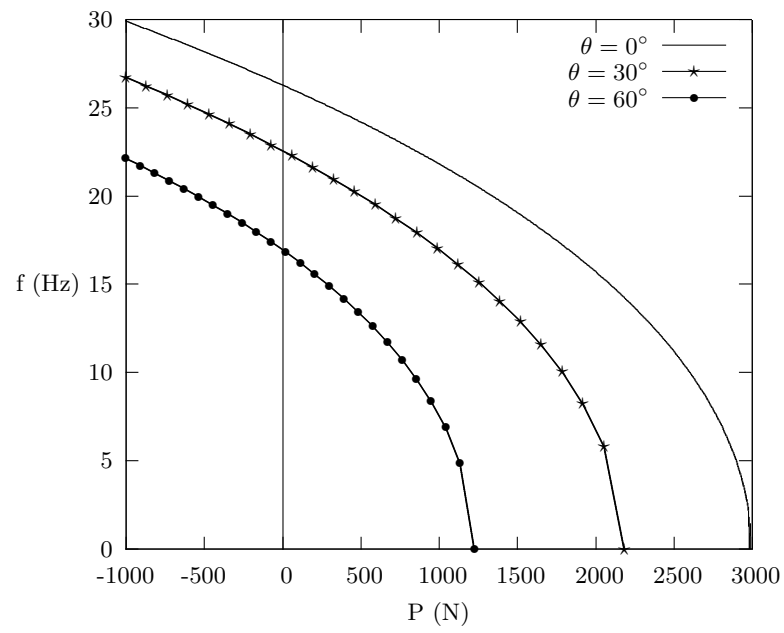

FIG. 2 Effect of axial force on the fundamental natural frequency with the fiber angles 0° , 30° and 60° in the flanges and web of a cantilever mono-symmetric composite I-beam.

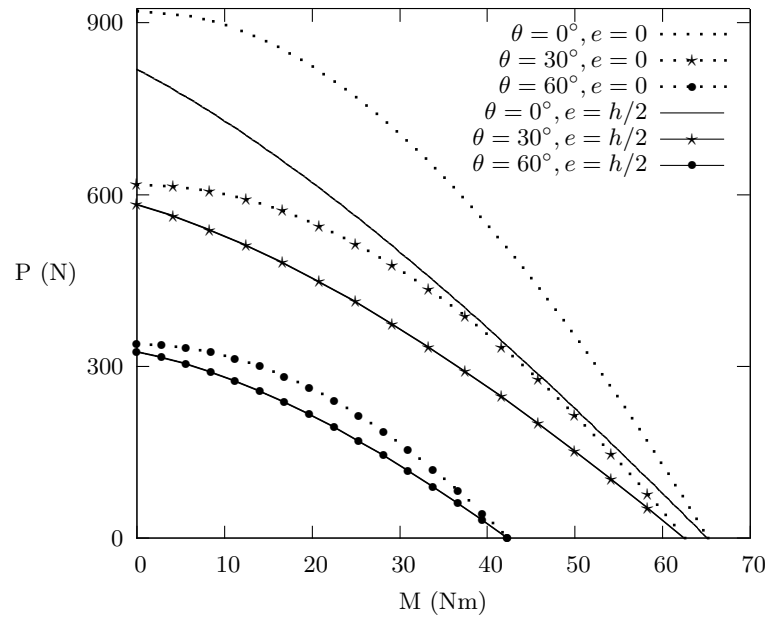

FIG. 3 Effect of eccentricity and axial compressive force on the critical buckling moments with the fiber angles 0° , 30° and 60° in the flanges and web of a simply supported composite beam.

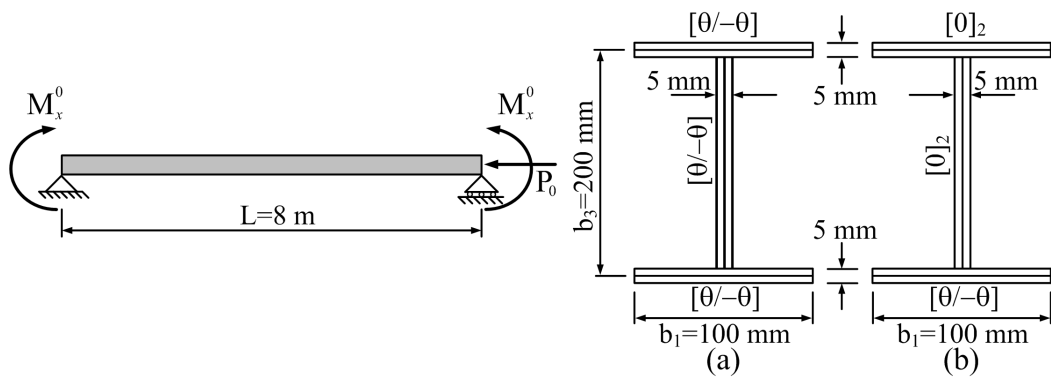

FIG. 4 Geometry and stacking sequences of a simply supported I-beam under axial load and uniform bending.

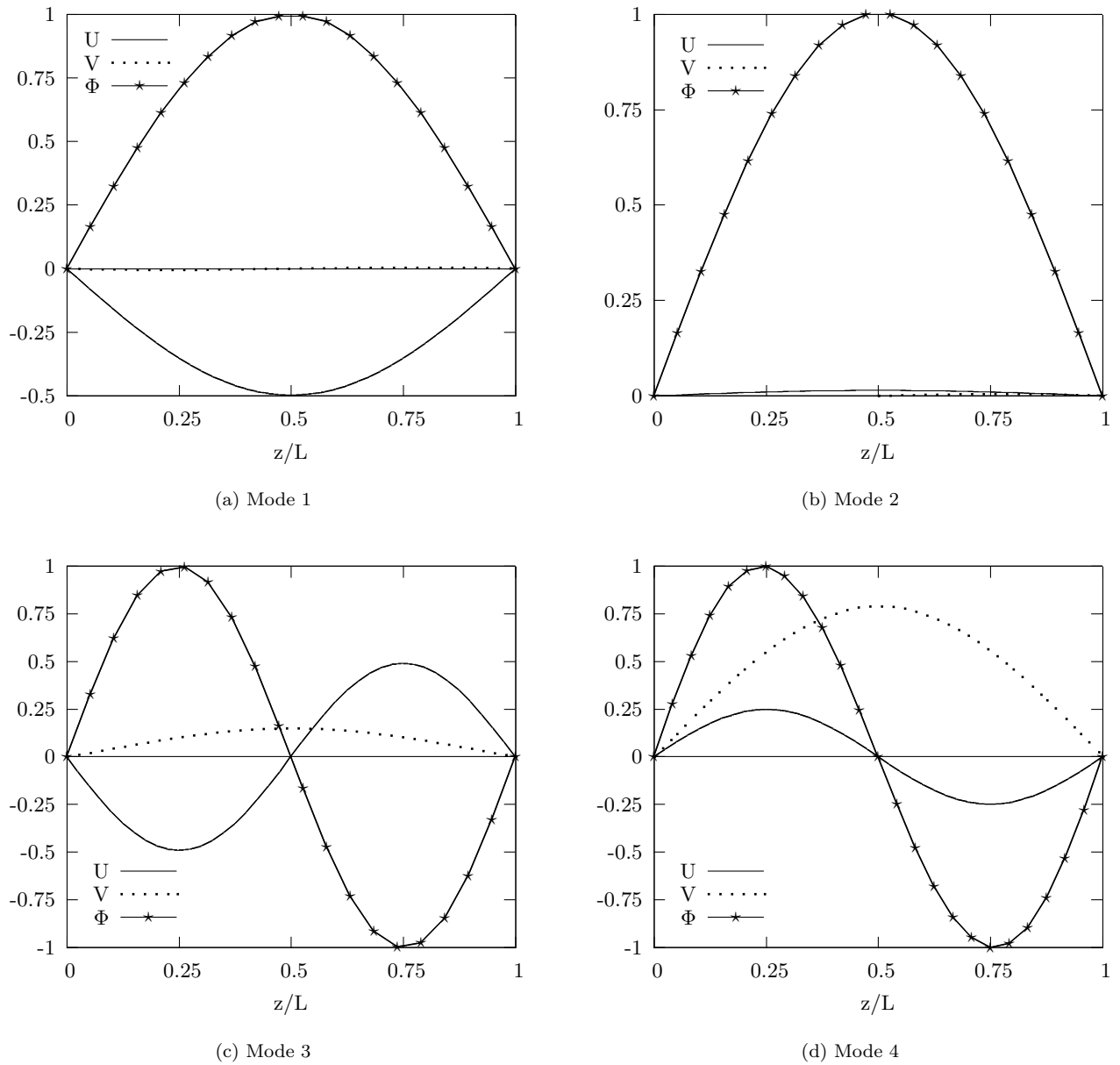

FIG. 5 The first four normal mode shapes of the flexural and torsional components with the fiber angle 30° in the flanges and web of a simply supported composite beam under an axial compressive force ($\bar{P} = 0.5\bar{P}_{cr}$) and bending moment ($\bar{M} = 0.5\bar{M}_{cr}$).

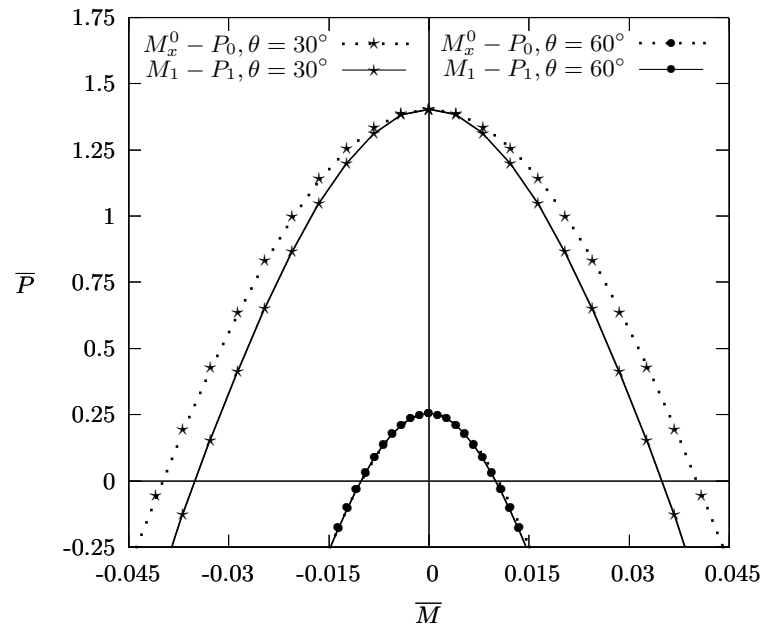

FIG. 6 Effect of axial force on the critical buckling moments with the fiber angles 30° and 60° in the flanges and web of a simply supported composite beam.

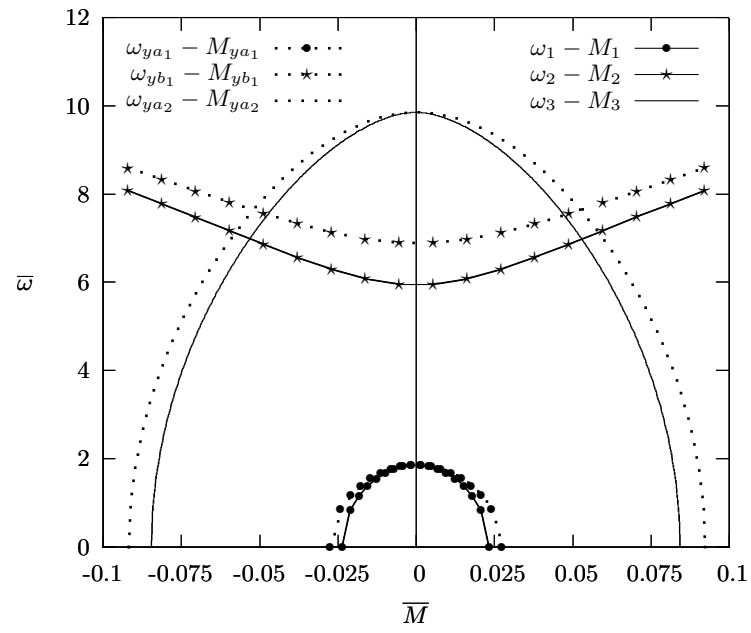

FIG. 7 Effect of bending moment on the first three natural frequencies with the fiber angle 30° in the bottom flange of a simply supported composite beam under an axial compressive force ($\bar{P} = 0.5\bar{P}_{cr}$).

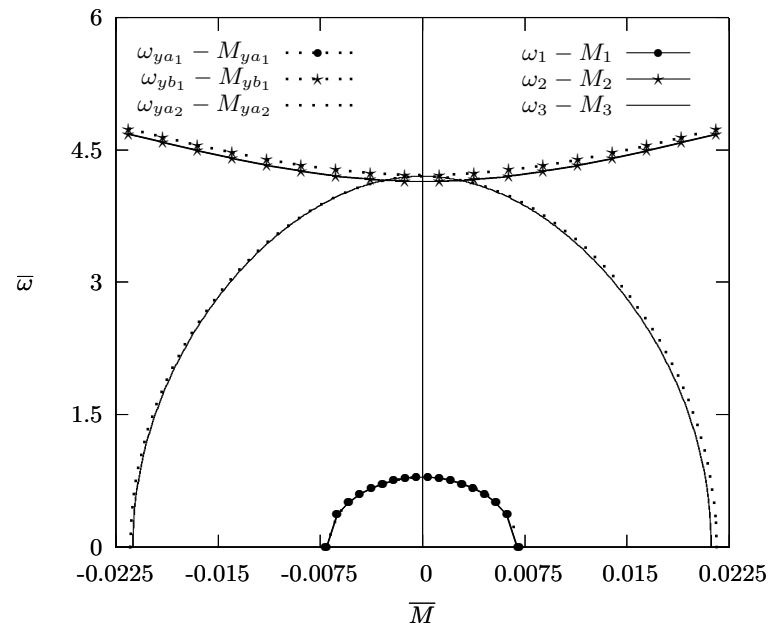

FIG. 8 Effect of bending moment on the first three natural frequencies with the fiber angle 60° in the bottom flange of a simply supported composite beam under an axial compressive force ($\bar{P} = 0.5\bar{P}_{cr}$).

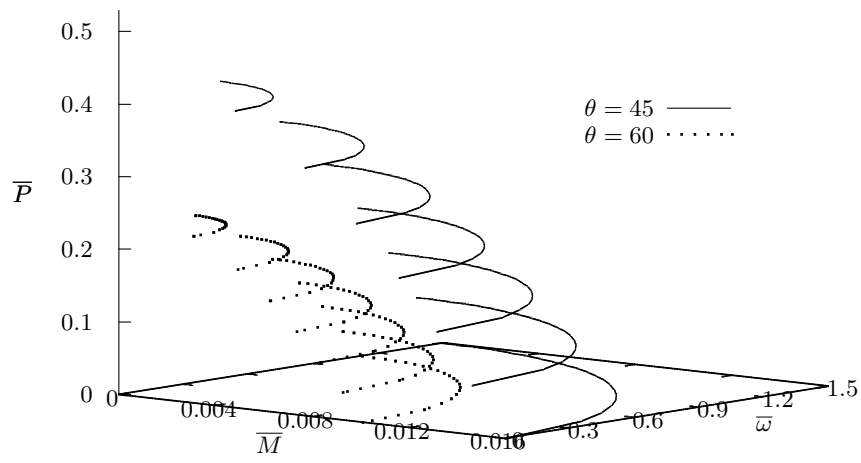

FIG. 9 Three dimensional interaction diagram of the fundamental natural frequency, bending moment and axial compressive force with the fiber angle 45° and 60° in the flanges and web of a simply supported composite beam.

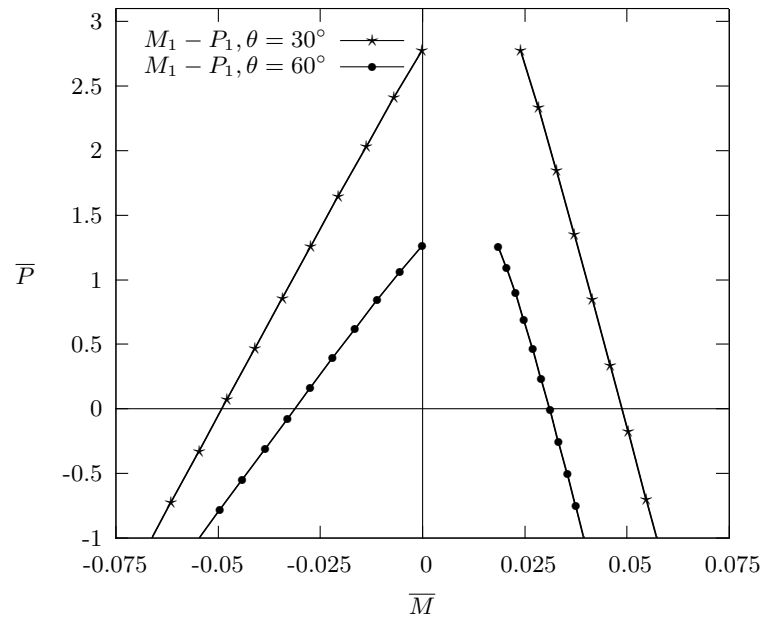

FIG. 10 Effect of axial force on the critical buckling moments with the fiber angles 30° and 60° in the bottom flange of a simply supported composite beam.

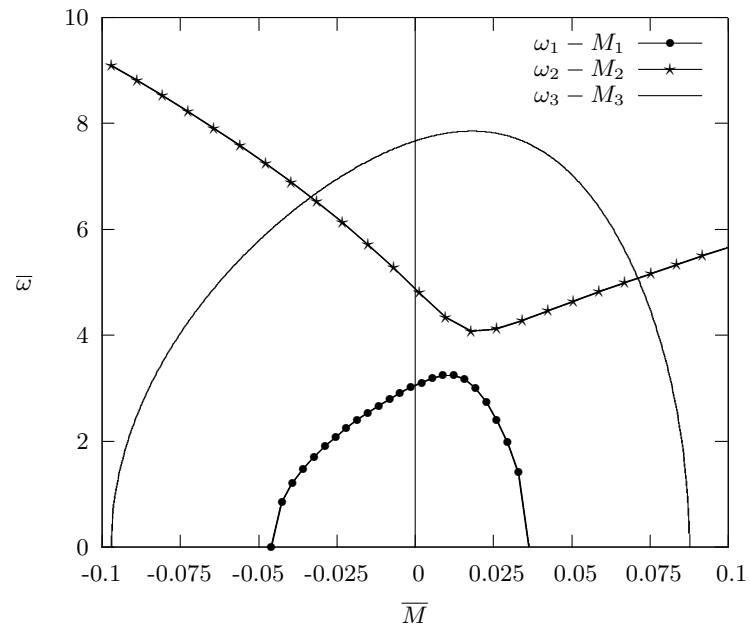

FIG. 11 Effect of bending moment on the first three natural frequencies with the fiber angle 60° in the bottom flange of a simply supported composite beam under an axial tensile force ($\bar{P} = -0.5\bar{P}_{cr}$).

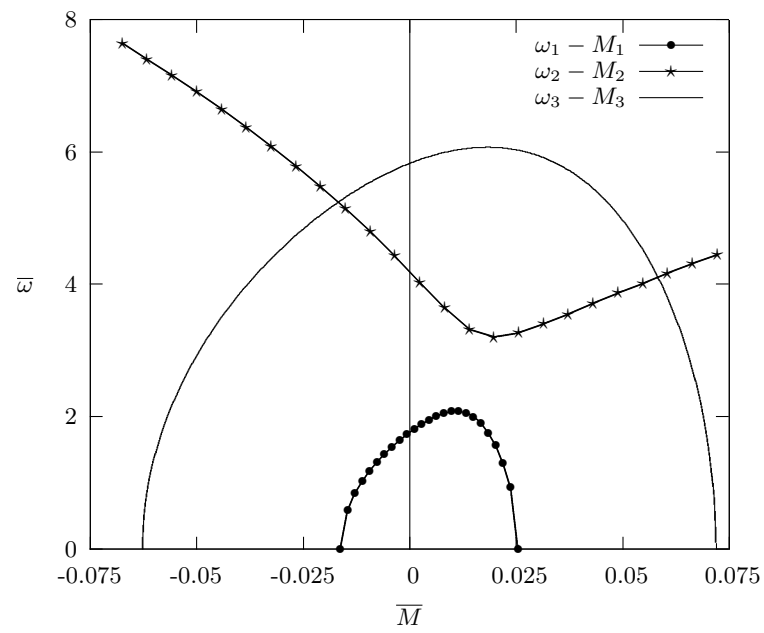

FIG. 12 Effect of bending moment on the first three natural frequencies with the fiber angle 60° in the bottom flange of a simply supported composite beam under an axial compressive force ($\bar{P} = 0.5\bar{P}_{cr}$).