

The Manufacturing Engineering Society International Conference, MESIC 2013

An Investigation into CO₂ Laser Trimming of CFRP and GFRP Composites

Islam Shyha^{a,b*}

^a Department of Mechanical & Construction Engineering, Northumbria University, Newcastle upon Tyne NE1 8ST, UK

^b Production Engineering Department, Faculty of Engineering, Alexandria University, Alexandria 21544, Egypt

Abstract

The paper outlines results for an investigation of CO₂ laser trimming of fibre reinforced plastic (FRP) composites. Process variables include cutting speed, laser beam power, gas pressure and workpiece material. These have been evaluated against key response measures involving material removal rate (MRR), surface roughness and kerf width. Higher MRRs have been obtained when trimming GFRP. Maximum MRR of 8 cm³/min was acquired when trimming GFRP at 1750 mm/min, 5 bar and 2500 watt respectively. Scanning electron microscope (SEM) analysis revealed that matrix constituent in both composites incurred to elevated cutting temperature which most likely resulted in a charring/melting and adhered to the cut surface which adversely affected its quality (Ra of up to ~ 6 µm). Maximum entry kerf width of 0.5 mm and 0.28 mm was measured for GFRP and CFRP samples respectively.

© 2013 The Authors. Published by Elsevier Ltd.

Selection and peer-review under responsibility of Universidad de Zaragoza, Dpto Ing Diseño y Fabricacion

Keywords: Laser trimming; CFRP; GFRP; composites

1. Introduction

Owing to their superior mechanical properties together with the very low thermal expansion coefficient, the use of carbon fibre reinforced plastic composites is significantly increasing in various industrial sectors. These include aerospace, automotive, electronics, medical and sports equipment components (Ahmad 2010). In the aerospace

* Corresponding author. Tel.: +44-191-243-7834; fax: +44-191-227-3598.

E-mail address: islam.shyha@northumbria.ac.uk / islam.shyha@alexu.edu.eg

sector, CFRP applications include aeroengine fan blades, casings, fuselage and wing components (Teti 2002), whilst in the bio-medical segment, CFRP accounts for hip-joint endoprosthesis (Kaddick, Stur et al. 1997). Finally in the sport equipment sector, CFRPs are used in bicycle frames, tennis racquets, sailboats and golf sticks. On the other hand, the use of glass fibre reinforced plastics is also growing in different industrial fields due to their useful bulk properties such as hardness, transparency, resistance to chemical attack, stability and inertness. GFRPs are used in structural components, storage tanks, printed circuit boards, automotive applications and a wide range of special-purpose products.

Parts fabricated from FRP composites are normally laid in the near-net-shape, however cutting operations such as trimming, drilling, grinding and slotting are still required to remove excess material and meet dimensional tolerances and requirements (Shyha, Soo et al. 2010; El-Hofy, Soo et al. 2011; Soo, Shyha et al. 2012). Conventional machining produces high cutting forces that, in some cases, may not be sustained by the workpiece (El-Hofy 2005). The use of laser machining for cutting composites is attractive due to its high cutting/travel speed, flexibility and ease of automation. However, it is not uncommon that laser, as a thermally acting tool, may damage the matrix element in the composite, which reduce the composites mechanical properties. While laser has been widely used in manufacturing including welding processes and as assisted technique in other processes, it is relatively less employed in cutting. Metallic materials however have been successfully machined using different types of laser beams with higher machinability rating for titanium alloys (Dubey and Yadava 2008). CO₂ lasers have been effectively used for cutting metals, ceramics and polymers (Riveiro, Quintero et al. 2012). With regard to composites machining, laser beam was relatively less used to cut CFRP and GFRP aiming at improving cutting productivity. The anisotropic properties of composites, lack of plastic deformation, poor thermal conductivity and issues related to the heat-affected zone (HAZ), charring, and potential delamination are the major complications for industrial applications with laser beam machining of composites (Negarestani, Sundar et al. 2010).

However, numerous reasons make CO₂ lasers attractive for cutting FRP composites as it is reported that tens of thousands of CO₂ laser cutting machines have been installed worldwide due to their good-quality beam combined with high output power (Riveiro, Quintero et al. 2012). Laser beam was originally used to cut glass, aramid and graphite composites in the 1980s (Tagliaferri, Di Ilio et al. 1985), while the first use on CFRP was undertaken in early 1990s when an Excimer laser was employed aiming to minimize the thermal effect and provide precise energy deposition. It was also reported that Excimer laser machining of CFRP is achievable with diminutive heat-affected zones (HAZ) of only 5–30 µm however; the main drawback was the limited laser power which resulted in very low cutting rates. Yet for relatively thin laminates of 0.7 mm thick, a maximum cutting speed of only 4.9 mm/min was used. It can be concluded that research on laser cutting of GFRP and CFRP is deemed limited especially using CO₂ laser beam. Additionally, the use of low cutting speeds (which does not meet today's market requirements and expectations) is arguably the focal drawback of laser cutting. Therefore, the present study is carried out to investigate the trimming of CFRP and GFRP composites using CO₂ laser beam in order to provide better understanding of the impact of key process variables on surface quality and productivity when employing relatively higher cutting speed in addition to identify the best/preferred levels for process control factors.

Nomenclature

CFRP	carbon fibre reinforced plastic
FRPs	fibre reinforced plastics
GFRP	glass fibre reinforced plastic
HAZ	head affected zone
MRR	material removal rate (cm ³ /min)
Ra	average surface roughness (µm)
SEM	scanning electron microscope
UD	unidirectional “fibre orientation”

2. Experimental Setup and Testing Plan

The experimental trials were carried out on a state-of-art Marbach Compact CO₂ laser cutting system (2115 DC-020). The machine is CNC controlled employing high-speed flatbed offering maximum cutting speed of 20,000 mm/min together with maximum cutting power of 2500 watt. Experimental setup is shown in Figure 1.

CFRP workpiece materials were manually laid up to provide nominally 3 mm thick symmetric UD CFRP laminates. All prepregs (pre-impregnated layer) used were 0.25 mm thick and 12 layers were subsequently laid up with the repeating fibre orientation of 45°/0°/135°/90°/45°/0°. The laminates were then cured according to the manufacturers' specifications to give a fibre weight fraction of ~ 65 % and subsequently cut into plates. GFRP workpiece materials were fabricated using contact molded hand lay-up (HLU) technique. Glass content was up to 35% by weight and final layup had a density of 1.5 g/cm³ and 3 mm thick. Both carbon and glass fibres had diameter ranges between 6 and 8 µm. A scanning electron microscope (SEM) and a conventional optical microscope were employed to characterise the surface damage induced laser trimming. Average surface roughness measurements were undertaken using surface roughness tester. The influence of process variables including cutting speed, laser beam power, CO₂ gas pressure and workpiece material were investigated against key response measures including material removal rate (MRR), surface roughness and geometrical accuracy in terms of kerf angle. Entry and exit Kerf width for all workpieces was linearly measured using optical microscope and kerf angle was subsequently calculated. Table 1 details process variables and their corresponding levels. A full factorial plan based on three factors (2 levels) and one factor (4 levels) was employed which entitles 32 tests.

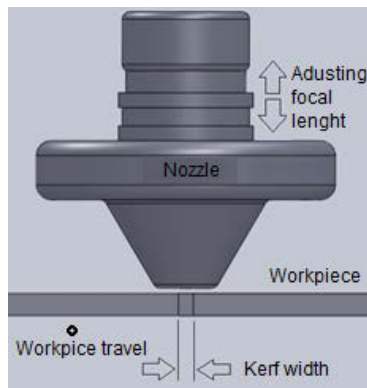

Figure 1. Experimental setup

Table 1. Process variables and their corresponding levels

Process variable	Level			
	1	2	3	4
Cutting speed (mm/min)	1000	1250	1500	1750
Laser beam power (watt)	2250	2500		
Gas Pressure (bar)	4	5		
Workpiece material	CFRP	GFRP		

3. Results and Discussion

Figure 2 shows the volumetric material removal rate (MRR) results for both workpiece materials versus cutting speed and at different gas pressure and beam power. MRR considerably increased with cutting speed regardless laser beam power or gas pressure settings. In general, MRRs at 1750 mm/min cutting speed exceeded twofold of those at 1000 mm/min especially when cutting GFRP. Maximum MRR of 8 cm³/min was achieved when cutting GFRP while only 4.2 cm³/min was the top level for CFRP. This can be attributed to the lower melting temperature of glass fibres compared with the carbon fibres. Findings also revealed that gas pressure and cutting power had very limited impact on the volumetric material removal rate although the MRR disparity in few occasions was up to 2 cm³/min. This is most likely due to the narrow variance of the investigated process variables, which was constrained by machine specification and operating limits. Figure 3 shows the main effects plot for MRR. The statistical analysis also showed that the main contributing factors on MRR were workpiece material and cutting speed (mean MRR for CFRP and GFRP were 3 and 5 cm³/min respectively). In addition, for higher MRR, statistical analysis showed that the best/preferred levels for process control factors when laser trimming of FRPs are 1750 mm/min, 2500 watt and 5 bar cutting speed, beam power and gas pressure respectively.

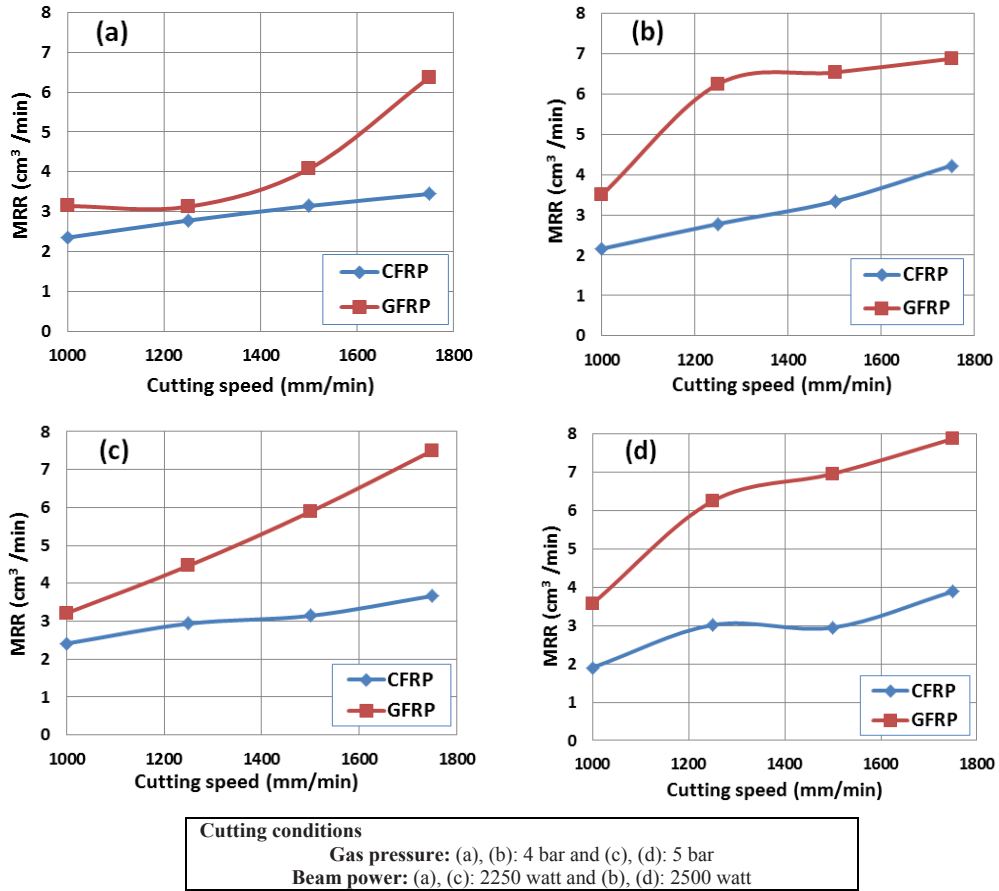

Figure 2. MRR results versus cutting speed for workpiece materials tested

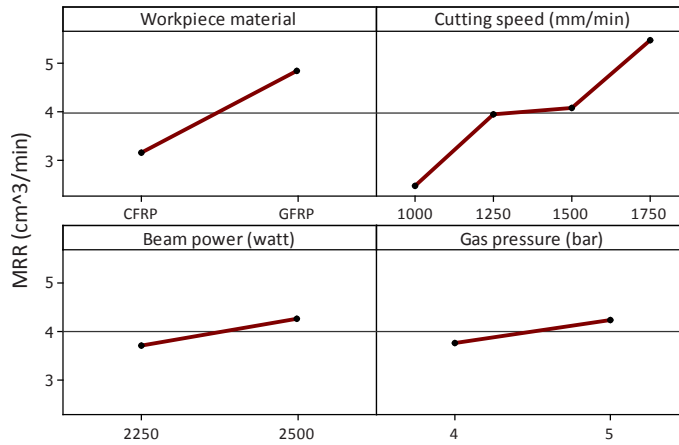

Figure 3. Main effects plot for MRR

Figure 4 shows average surface roughness (Ra) results for both workpiece materials when cutting at 5 bar pressure and at different cutting speeds. The maximum Ra ($6.3 \mu\text{m}$) was measured for samples trimmed at 1750 mm/min. Although this figure is not uncommon when cutting fibre reinforced plastic composites but it still exceeds the accepted surface roughness limits as defined by the aerospace industry ($3.2 \mu\text{m}$ Ra). The use of higher cutting speeds adversely affected surface quality and relatively lower surface roughness results were obtained when lower cutting speeds were employed. This is attributed to the strong correlation between surface quality and interaction time between the beam and the workpiece surface when laser cutting of FRPs, hence cutting speed [7]. When high cutting speeds are used, insufficient interaction time between laser beam and fibres/matrix surface causes incomplete cut and subsequently results in improper surface quality and higher surface roughness.

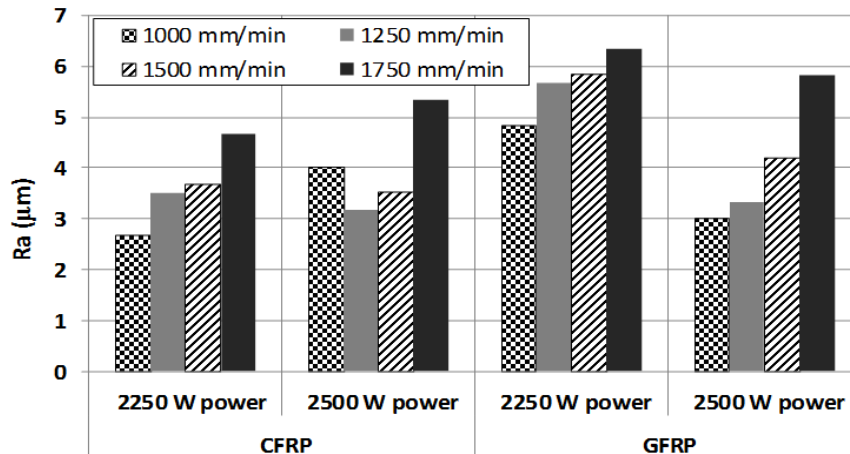
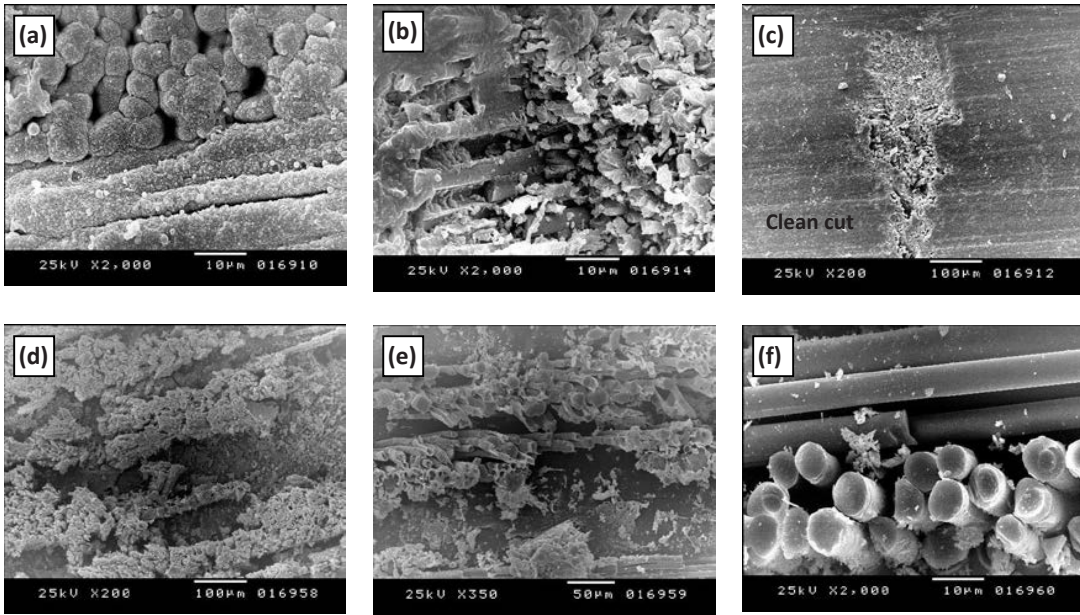

Figure 4. Surface roughness results for CFRP and GFRP surfaces when cut at 5 bar pressure

Additionally, several surface damage forms have been observed during the analysis of the trimmed surfaces using scanning electron microscopy, see Figure 5. Premature charring/melting of matrix component (resin) was dominant especially when cutting CFRP. The charred/melted segments sometimes adhered to the machined surface which may explain the elevated surface roughness values mentioned earlier (a). SEM images also showed evidence of interlayer fracture and fibre pull out (c), which may reduce surface integrity and subsequently fatigue life of the component when put into service. Adhered fibre/matrix clusters have been also seen which indicate the improper removal of the workpiece segments from the cutting zone (d). This can be improved by reducing the travel speed in order to ensure sufficient interaction time hence removal of segregated clumps and prevent adhering to the machined surface. Excessive thermal damage in the form of burning/charring of matrix constituent from fibre/matrix interface is another phenomenon that has been captured by SEM (f). This probably reduced surface quality as fibres would be left unaccompanied and can be considered as one of the reasons for the high surface roughness values. It may also lead to fibre/matrix interface cracking and constricts material properties. The dominant surface damage type observed was the uneven cutting of the fibre and matrix which has been seen in the several trimmed surfaces (e.g. b & e). This is attributed to the anisotropic properties of composite constituents (fibre and matrix) and was in agreement with previous research (Soo, Shyha et al. 2012).

Figure 6 shows the kerf width results for both workpiece materials at different cutting speeds. In general, kerf width is marginally greater at cut entry which is most likely due to the limited variation in the laser beam size along the focal length. Additionally, an inverse relationship between the kerf width and cutting speed was determined for both materials. At lower cutting speed, interaction time between the laser beam and the workpiece material increases which subsequently rises temperature in the cutting zone and most likely removing more workpiece material. Figure 7 shows the pertinent kerf angle results. In general, less than 1° angle was obtained for all tests which highlight the ability of producing features having insignificant geometrical errors when laser trimming of FRP composites.



Surfaces produced at dissimilar cutting conditions; CFRP: (a), (b), (c) and GFRP: (d), (e), (f)

Figure 5. Surface damage types observed using SEM analysis

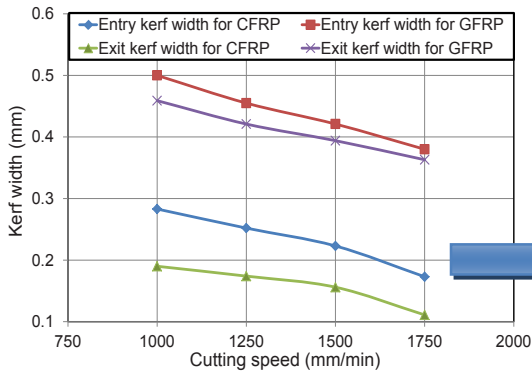

Figure 6. Kerf width results versus cutting speed (4 bar gas pressure and 2500 watt beam power)

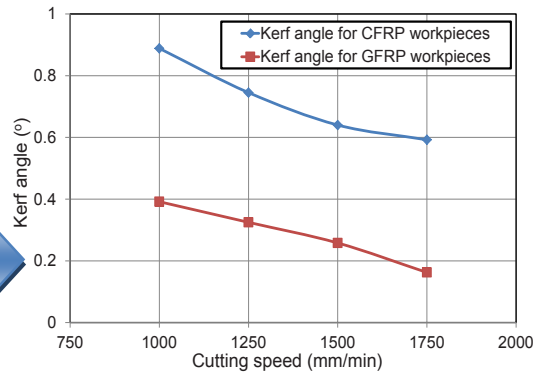

Figure 7. Kerf angle results versus cutting speed (4 bar gas pressure and 2500 watt beam power)

4. Conclusions

A study of CO₂ laser trimming of CFRP and GFRP composites has been carried out to investigate the influence of process variables on key outputs including MRR, entry/exit kerf width (kerf angle) and surface roughness. Cutting speed was the main contributing factor affecting the surface quality and volumetric material removal rate. MRR results in the case of GFRP were always greater than CFRP (maximum MRR of 8 cm³/min was achieved). For higher MRR, the best/preferred levels for process control factors when laser trimming of FRPs were 1750 mm/min, 2500 watt and 5 bar cutting speed, beam power and gas pressure respectively. In general, average surface

roughness ranged between 2.7 μm and 6.3 μm . Although, this is not uncommon when cutting fibre reinforced plastics but more investigation is deemed necessary in order to reduce these high levels. Understandably, kerf width declined with higher cutting speeds and maximum value was recorded for the GFRP workpiece (0.5 mm at a cutting speed of 1000 mm/min).

Acknowledgements

The author would like to thank Prof. David Aspinwall and Dr Leung Soo (School of Mechanical Engineering, University of Birmingham) for their continuous advices and help. Thanks also go to Prof. Hassan El-Hofy (Dean of Faculty of Engineering, Egypt-Japan University of Science and Technology, Egypt) for his scientific support and advices. The author would also like to thank the School of Mechanical Engineering, University of Birmingham for the provision of the CFRP workpiece materials. The author would also like to express sincere gratitude to the final year project students at the department of production engineering, Alexandria University for their help in performing experimental trials.

References

- Ahmad, J., 2010. *Machining of Polymer Composites*, Springer.
- Dubey, A. K. and V. Yadava, 2008. Experimental study of Nd:YAG laser beam machining—An overview. *Journal of Materials Processing Technology* 195(1–3): 15-26.
- El-Hofy, H. A. G., 2005. *Advanced Machining Processes: Nontraditional and Hybrid Machining Processes*, McGraw-Hill.
- El-Hofy, M. H., S. L. Soo, et al., 2011. Factors Affecting Workpiece Surface Integrity in Slotting of CFRP. *Procedia Engineering* 19(0): 94-99.
- Kaddick, C., S. Stur, et al., 1997. Mechanical simulation of composite hip stems. *Medical Engineering & Physics* 19(5): 431-439.
- Negarestani, R., M. Sundar, et al., 2010. Numerical simulation of laser machining of carbon-fibre-reinforced composites. *Proceedings of the Institution of Mechanical Engineers, Part B: Journal of Engineering Manufacture* 224(7): 1017-1027.
- Riveiro, A., F. Quintero, et al., 2012. Experimental study on the CO₂ laser cutting of carbon fiber reinforced plastic composite. *Composites Part A: Applied Science and Manufacturing* 43(8): 1400-1409.
- Shyha, I., S. L. Soo, et al., 2010. Effect of laminate configuration and feed rate on cutting performance when drilling holes in carbon fibre reinforced plastic composites. *Journal of Materials Processing Technology* 210(8): 1023-1034.
- Soo, S. L., I. S. Shyha, et al., 2012. Grinding performance and workpiece integrity when superabrasive edge routing carbon fibre reinforced plastic (CFRP) composites. *CIRP Annals - Manufacturing Technology* 61(1): 295-298.
- Tagliaferri, V., A. Di Ilio, et al., 1985. Laser cutting of fibre-reinforced polyesters. *Composites* 16(4): 317-325.
- Teti, R., 2002. *Machining of Composite Materials*. *CIRP Annals - Manufacturing Technology* 51(2): 611-634.