

# Northumbria Research Link

Citation: Yates, D. J., Hughes, Lawrence and Campbell, A. (2007) Sound insulation design of modular construction housing. In: Institute of Acoustics Spring Conference 2007, 24-25 April 2007, Cambridge.

URL:

This version was downloaded from Northumbria Research Link:  
<https://nrl.northumbria.ac.uk/id/eprint/3255/>

Northumbria University has developed Northumbria Research Link (NRL) to enable users to access the University's research output. Copyright © and moral rights for items on NRL are retained by the individual author(s) and/or other copyright owners. Single copies of full items can be reproduced, displayed or performed, and given to third parties in any format or medium for personal research or study, educational, or not-for-profit purposes without prior permission or charge, provided the authors, title and full bibliographic details are given, as well as a hyperlink and/or URL to the original metadata page. The content must not be changed in any way. Full items must not be sold commercially in any format or medium without formal permission of the copyright holder. The full policy is available online: <http://nrl.northumbria.ac.uk/policies.html>

This document may differ from the final, published version of the research and has been made available online in accordance with publisher policies. To read and/or cite from the published version of the research, please visit the publisher's website (a subscription may be required.)

# SOUND INSULATION DESIGN OF MODULAR CONSTRUCTION HOUSING

D Yates  
L Hughes  
A Campbell

Buro Happold Ltd, London, UK  
Buro Happold Ltd, Newcastle, UK  
WSP, Bristol, UK

## 1 INTRODUCTION

This paper provides an insight into the acoustic issues of modular housing using the Verbus System of construction. The paper briefly summarises the history of the development of Verbus modular housing and the acoustic design considerations of the process. Results are presented from two sound insulation tests conducted during the course of the project. The results are discussed in terms of compliance with Approved Document E<sup>1</sup> and increased performance standards such as EcoHomes<sup>2</sup>.

## 2 BACKGROUND TO VERBUS

Verbus Systems is a supplier of prefabricated modules designed primarily for use in the construction of residential developments. The system is designed to reduce construction time, reduce environmental impact and speed-up fit-out.

The Verbus system aspires to provide sustainability to the building design. The system has the ability to be recycled, refurbished, relocated and resized, which can provide cost savings that are then available to be employed in improving internal environments in energy efficient systems and internal finishes. Verbus aspires to meet best practices in sustainable building design and construction such as EcoHomes and BREEAM.

A Verbus unit is a monocoque steel structure built with shipping container technology from corrugated sheet steel and rolled steel sections. Units can be stacked vertically up to 16 storeys high to form the structural frame of a building.

The units are pre-fitted at the production stage with thermal insulation and plywood lining. Electrical, mechanical and plumbing services can be pre-fixed to the units, with the possibility of installing plasterboard finishing and prefabricated bathroom pods. The completed Verbus frame is clad on site using standard cladding systems to give the finished appearance of a conventional building.

The aim of Verbus is to produce a design solution that would be easily repeated and constructed, and hence in terms of acoustics achieve a 'Robust Detail' status.

### 3 INITIAL ACOUSTIC ISSUES WITH DESIGN OF VERBUS SYSTEM

#### 3.1 Compliance with standards

The minimum standards for acoustic compliance for residential or dwelling rooms are stated in The Building Regulations Part E (see Table 1). Hotel operators often refer to their own criteria which can be more onerous. Increased sound insulation performance criteria can be found in The Building Research Establishment's (BRE) Guide BR406 'Specifying dwellings with enhanced sound insulation'<sup>3</sup>.

		Airborne Sound Insulation $D_{nT,w} + C_{tr}$ dB (Minimum Values)	Impact Sound Insulation $L'_{nT,w}$ dB (Maximum Values)
<b>Dwelling-houses and flats</b>	Walls	45	N/A
	Floors and Stairs	45	62
<b>Rooms for Residential Purposes</b>	Walls	43	N/A
	Floors and Stairs	45	62
<b>Enhanced sound insulation (BR406)</b>	Walls	50	N/A
	Floors	52	55

Table 1: Sound insulation values for compliance with Part E and BR406

New building developments are often required to meet certification standards which include improved sound insulation performance between living spaces. As an example the EcoHomes certification provides minimal points for meeting Approved Document E but awards extra points for achieving 3dB or 5dB increase in airborne sound insulation and 3dB or 5dB decrease in impact sound insulation values set in Approved Document E.

Façade design for a Verbus System building will need to be assessed on a site-by-site basis due to variance in external noise levels from location-to-location. Typically the combined cladding and modular construction will be specified to meet World Health Organisation internal ambient noise level standards<sup>4</sup> or similar criteria.

#### 3.2 Design considerations for the modules

Verbus containers are constructed from a steel lightweight structure which without proper detailing could provide a weak resistance to sound propagation for both airborne and impact sound. The added factor of small self contained units might cause an uncomfortable environment in terms of quality and perception.

The level of airborne sound insulation that the existing module container could achieve was unknown at the early stages of design. A construction using 2 x 9mm Plasterboard connected to 10mm plywood supported on 75mm L brackets with 40mm of mineral wool in the cavity, was assessed to provide the required airborne sound insulation. The void between the 1.4mm steel container walls varies between 20mm to 55mm (Figure 1).

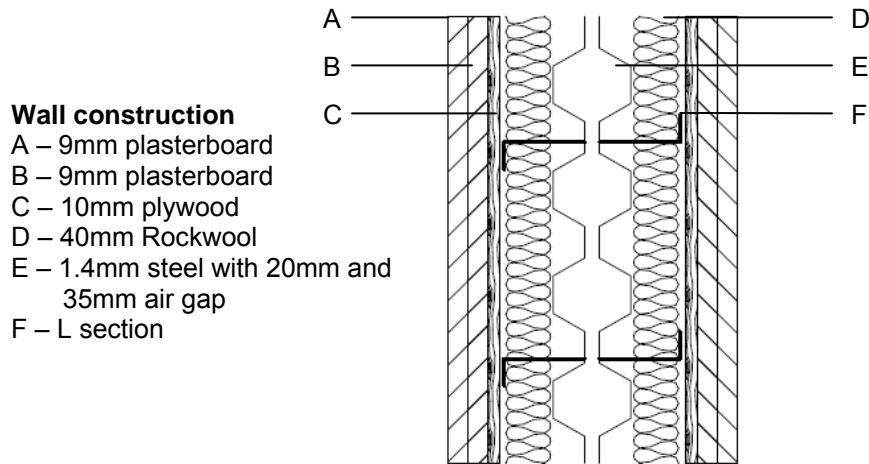

Figure 1: Typical wall construction of Verbus Module

Floor construction designs are similar to the wall constructions, replacing Plasterboards with plywood for the floor finish. These were to include a resilient pad/layer between the bracket and plywood to control impact noise (Figure 2).

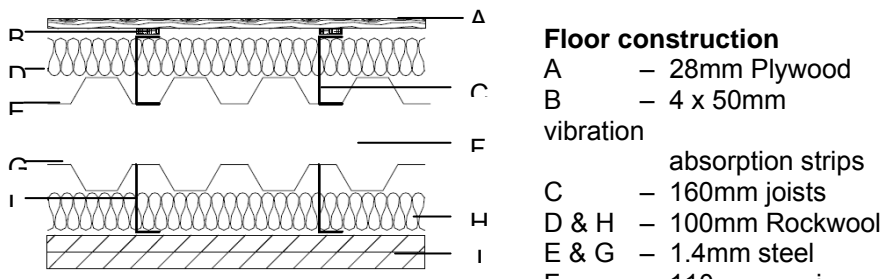

Figure 2: Typical floor construction of Verbus Module

Due to concerns regarding flanking paths, the support pads for the modules were designed to include a resilient layer to reduce transmission of structure-borne noise through the connectors. The design specified a resilient material with a constant bulk modulus which would alter in area to achieve the required stiffness level. The required stiffness of resilience between modules in a multi-storey development (effectively a multi-degree of freedom system) varies with height. The location of the resilient material also provides protection against noise due to thermal movements.

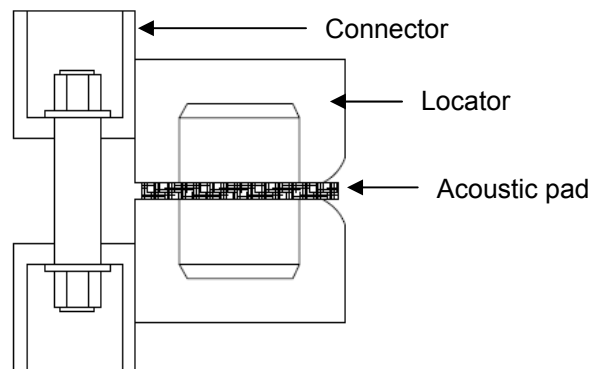

Figure 3: Detail of the connector and locator with resilient material between vertical units

Connection of the modules is based on variations of standard module connectors for shipping containers (Figure 4). The connectors potentially provide a flanking path route directly between neighbouring modules.

The initial design proposed two solutions that included resilient material to reduce the structure-borne noise transfer. In practice the thickness of the resilient material that could be used in the connectors is limited due to the small tolerances involved in the design of the connectors. The proposed design of resilient materials in the connectors provided excessive friction in the locking mechanism and therefore could not be used.

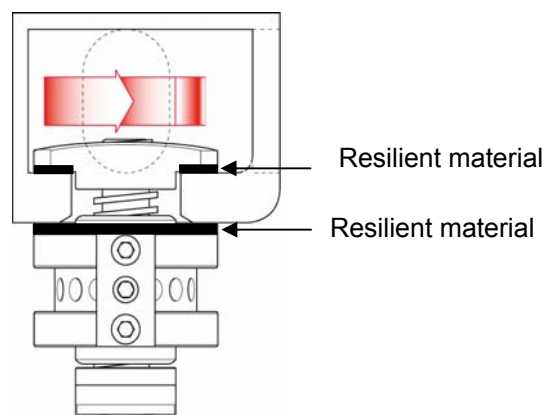

Figure 4: Detail of the initial design of the connector

Vertical circulation such as stairwells and lifts can be located in an independent module providing isolation and therefore reducing structure-borne noise transfer.

### 3.3 Prototype Development

A prototype of 3 units of Verbus System modular housing was available for sound insulation tests in February 2005. The prototype was specified and constructed to represent a possible single dwelling containing living areas, a bedroom, kitchen and bathroom.

An unexpected practical problem occurred in the prototype modules. Transportation of the container applied a dry, airtight seal unit to the module. Once opened and subjected to humidity it caused the floor construction to buckle. This was resolved on subsequent developments by not completely de-humidifying the container at pre-shipping stage.

It was noticed after module assembly that the connectors for each module were left without the resilient material and no provision had been made to control the flanking path for structure-borne noise transfer via the connector. The acoustic tests therefore reflected 'worst case' flanking conditions.

As the prototype was a single dwelling, there were no possible horizontal partitions to perform SI testing and therefore the results at this stage solely reflect the vertical airborne sound insulation properties.

Measurement direction	Part E DnT,w + Ctr (dB)	Result DnT,w + Ctr (dB)	Part E L'nT,w (dB)	Result L'nT,w (dB)
Ground bedroom to first floor	43	62	N/A	N/A
First floor to ground bedroom	43	60	62	30

Table 2: Verbus prototype testing results

Trapped air pockets provided issues with vibration and panel resonance of the floors. On the prototype the perimeter of the module between the ground and first floor modules had been sealed for thermal insulation reasons. The air then trapped between the modules was found to be stiff enough to cause increased vibration transfer through the floor when excited by large impacts (for example, a person jumping). This did not affect impact noise results directly but is an effect requiring further investigation.

## 4 DESIGN DEVELOPMENT

### 4.1 Testing

The first building to use the Verbus system for construction and available for acoustic testing, was an extension to the Travelodge on the A36 Warminster bypass. The extension consists of 2 Verbus units vertically and 6 units horizontally adjacent to the original Travelodge building. There are 2 bedrooms located in each module with a corridor running down a central spine. A pre-fabricated bathroom pod is located within each bedroom (Figure 5).

The building was tested for compliance with Part E / Travelodge requirements. The tests comprised of 3 full sets of tests to ensure that over 10% of rooms had been tested. All tests were conducted in accordance to ISO 140-4:1998 'Field Measurements of airborne sound insulation between rooms'<sup>5</sup> and ISO 140-7:1998 'Field Measurement of impact sound insulation of floors'<sup>6</sup>.

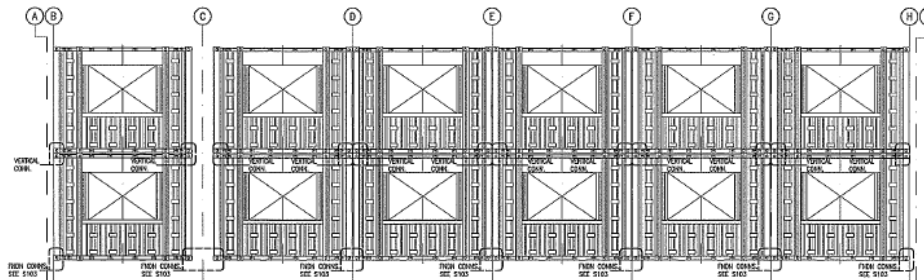

Figure 5: Elevation of Travelodge Warminster and layout of a typical unit

This construction did include resilient pads between modules, though the primary reason was to control potential noise due to thermal movements (Figure 3). These were only intended to stop the direct metal to metal contact of the connections of the units and not to reduce flanking noise, so hence could be bridged to provide increased structural integrity

Travelodge fit-out requirements have changed since the construction on this project, but at the time required back-to-back recessed sockets in each room. The electrical sockets were recessed through the plasterboard and plywood inner wall linings, although still within the steel container module that formed each room.

It was agreed that relying on the plastic sockets with thin steel on either side of the rooms would not be sufficient, and proprietary putty pads were used to seal round the back of the recessed sockets for additional protection (Figure 6).

It was not possible to box the rear of the sockets in with the plasterboard linings, as there was limited space between the rear of the socket boxes and the steel module wall.

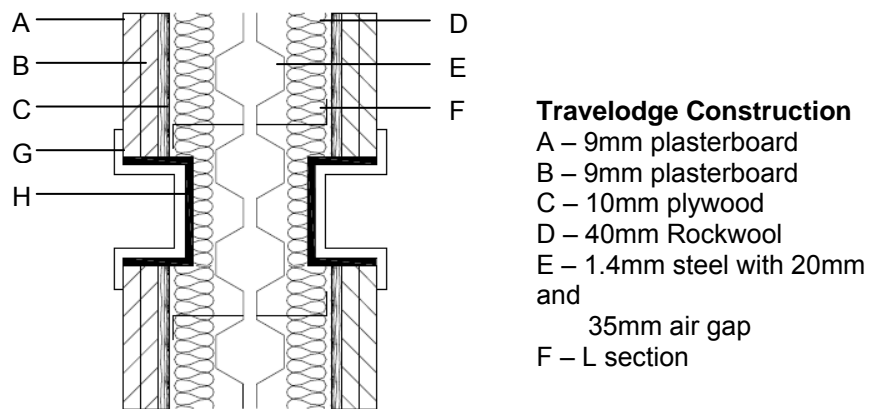

Figure 6: Wall construction detail for Travelodge Warminster

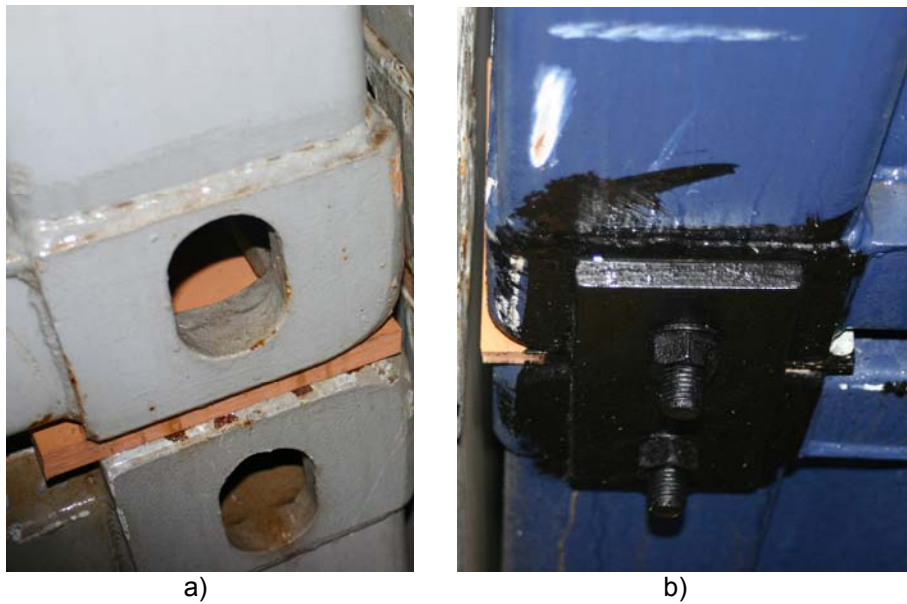

Figure 7: Photographs of construction stage of Travelodge Warminster. a) Locator and resilient pad. b) Locator, connector and resilient pad

## 4.2 Results

Results for the testing on the prototype can be seen in Table 3 to Table 5. EcoHomes targets are included for comparative purposes.



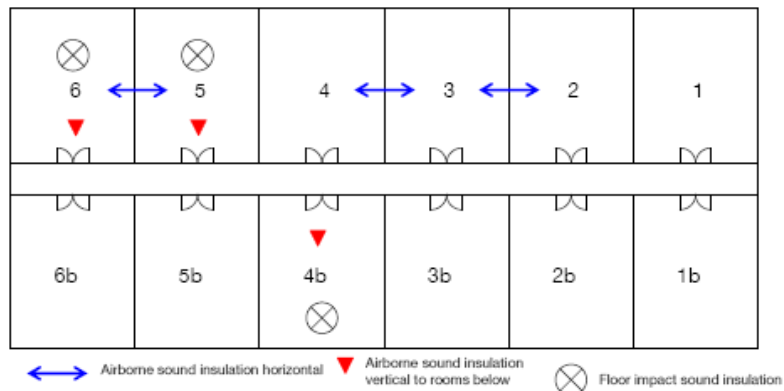

Figure 8: Plan view of test arrangement

Horizontal Airborne Sound Insulation Test				
Measurement direction	Part E DnT,w + Ctr (dB)	EcoHomes maximum credit rating DnT,w + Ctr (dB)	Result DnT,w + Ctr (dB)	Compliance
2a → 3a	43	48	50	Pass
3a → 2a	43	48	52	Pass
3a → 4a	43	48	53	Pass
4a → 3a	43	48	52	Pass
5a → 6a	43	48	49	Pass
6a → 5a	43	48	47	Pass <sup>†</sup>

<sup>†</sup> More than 3dB higher than Part E passes EcoHomes credit rating of 3 points

Table 3: Horizontal sound insulation test results from Warminster Travelodge

Vertical Airborne Sound Insulation Test				
Measurement direction	Part E DnT,w + Ctr (dB)	EcoHomes maximum credit rating DnT,w + Ctr (dB)	Result DnT,w + Ctr (dB)	Compliance
6a (1 <sup>st</sup> ) → 6a (GR)	43	48	55	Pass
6a (GR) → 6a (1 <sup>st</sup> )	43	48	54	Pass
5a (1 <sup>st</sup> ) → 5a (GR)	43	48	57	Pass
5a (GR) → 5a (1 <sup>st</sup> )	43	48	55	Pass
4b (1 <sup>st</sup> ) → 4b (GR)	43	48	54	Pass
4b (GR) → 4b (1 <sup>st</sup> )	43	48	64	Pass

Table 4: Vertical sound insulation test results from Warminster Travelodge

Impact Sound Insulation Test				
Measurement direction	Part E L'nT,w + Ctr (dB)	EcoHomes maximum credit rating L'nT,w (dB)	Result L'nT,w (dB)	Compliance
6a No carpet	62	57	54	Pass
5a No carpet	62	57	55	Pass
4b No carpet	62	57	55	Pass
6a With carpet	62	57	26	Pass
5a With carpet	62	57	28	Pass
4b With carpet	62	57	27	Pass

Table 5: Impact sound insulation test at Warminster Travelodge

Based on the results from Warminster Travelodge, the Verbus module system is compliant with the minimum standards set out in the Approved Part E document. Further to achieving these minimum levels, the results verify the partition's high level of performance for airborne sound insulation and impact sound insulation, with the majority of tests achieving maximum EcoHomes rating. The results also comply with standards for Scotland<sup>7</sup>.

Scottish Building Regulations			
Measurement direction	BS EN ISO 717-1 and 2 Mean Value	Mean Result	Compliance
Walls DnT,w (dB)	53	57	Pass
Floors (airborne sound insulation) DnT,w (dB)	52	65	Pass
Floor without carpet (impact) L'nT,w (dB)	61	55	Pass
Floor with carpet (impact) L'nT,w (dB)	61	27	Pass

Table 6: Arithmetic average of results compared with Scottish Building Regulations

The results confirm required standards can be achieved without resilient material in connectors and locators.

Figure 9 is a typical DnT curve for a horizontal test on a Verbus Partition.

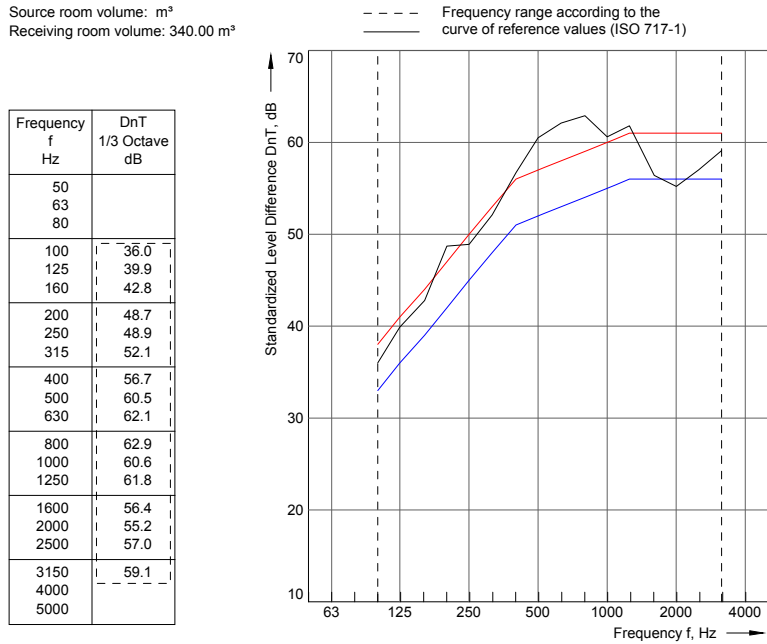

Figure 9: DnT curve for horizontal airborne sound insulation test 3a to 2a

Figure 10 is a typical DnT curve for a vertical test on a Verbus Partition.

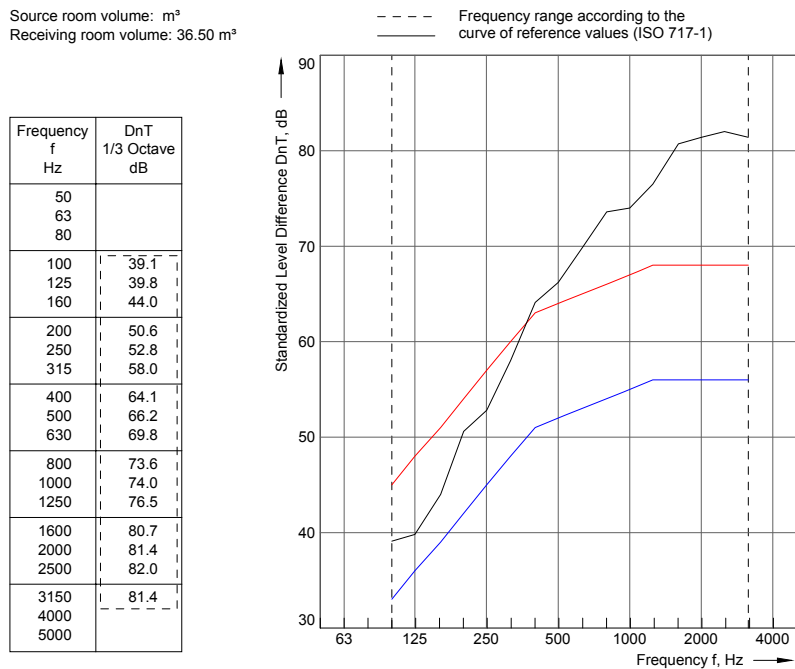

Figure 10: DnT curve for vertical airborne sound insulation test for 6a first floor to ground level

Figure 11 and Figure 12 show the DnT curves for room 6a impact tests with and without carpet respectively.

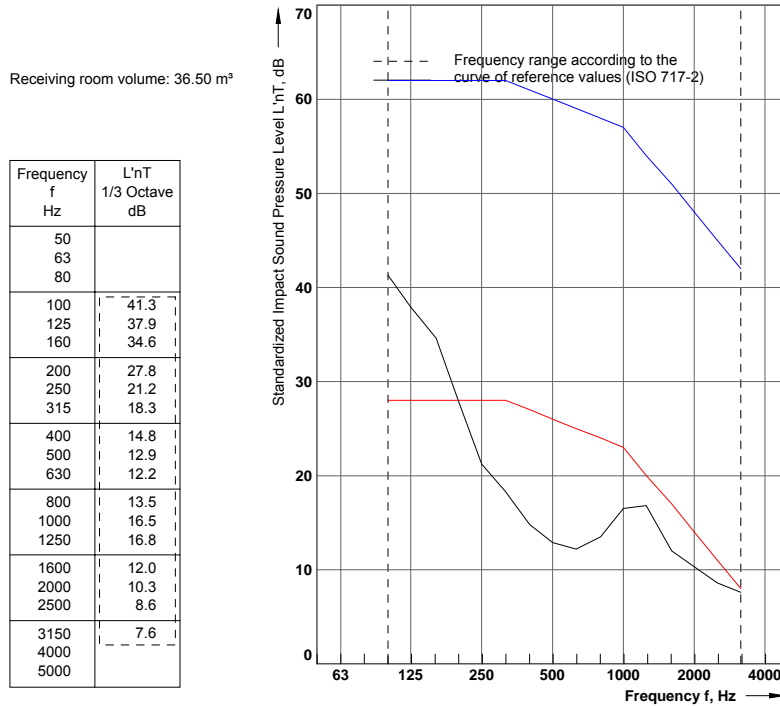

Figure 11: A typical curve for impact sound insulation with carpet

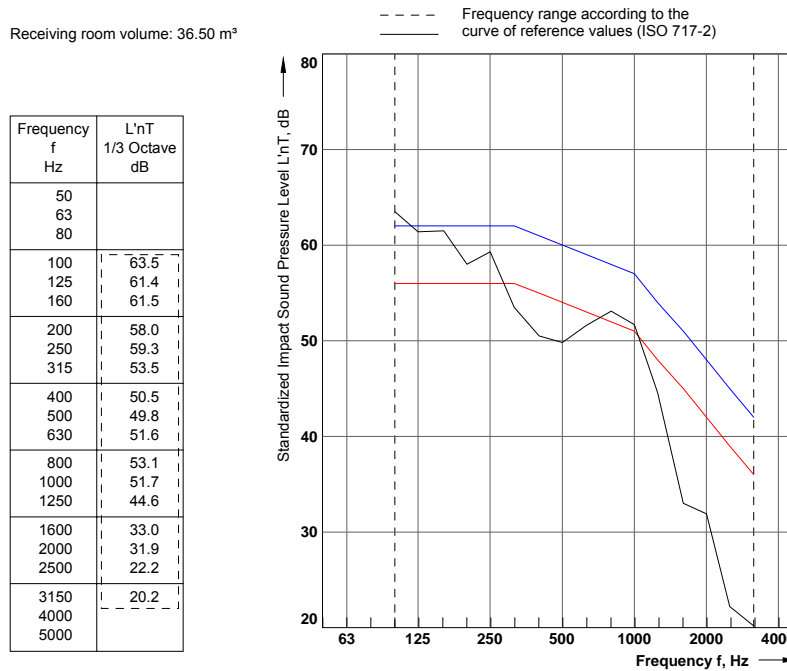

Figure 12: A typical curve for impact sound insulation without carpet

## 5 FUTURE WORK

Developments with the project will assess the discovery from the prototype assessment of the trapped air pocket between two units vertically. This effect has only occurred on the sealing of one unit.

Proposed design changes to Verbus modules include alternatives to the resilient layers used between modules in the Travelodge Warminster building and alternative wall constructions. Investigations are underway looking at various types of plastic material which will reduce the coefficient of sliding friction between module connections, as this material does not specifically have to be a resilient one. Changes are occurring to the wall construction linings for fire safety design.

It would be of interest to see the level of the overall effect of the proprietary putty pads used to seal behind recessed sockets, and to see if this has made a significant effect to the acoustic performance of the partition. It may be possible to omit this as a cost saving.

## 6 SUMMARY

The Verbus Modular system can successfully meet sound insulation standards for dwellings or rooms for residential purposes. The standard module for a development will comply with the performance requirements in Approved Document E.

The modules have sufficient sound insulation to meet increased performance standards. The first full construction has shown that the modules are capable of gaining maximum credit under the EcoHomes certification rating.

The Verbus system is going through a continuing design process. Knowledge gained through amendments to the design will be included in further development of constructions using the Verbus system. Further investigations into the design and the increase in the number of developments using the construction method will hopefully lead the system to be adopted as a 'Robust Detail' solution.

## 7 REFERENCES

1. The Building Regulations 2000 Approved Document E, Resistance to the passage of sound, Office of the Deputy Prime Minister, 2004.
2. EcoHomes, [http://www.breeam.org/filelibrary/EcoHomes\\_2006\\_Guidance\\_v1.2\\_-\\_April\\_2006.pdf](http://www.breeam.org/filelibrary/EcoHomes_2006_Guidance_v1.2_-_April_2006.pdf), BREEAM, March 2007
3. BRE, Specifying dwellings with enhanced sound insulation, a guide, Construction Research Communications Ltd, 3-5. (2000)
4. HMSO, Planning Policy Guide 24, Planning and Noise, HMSO Publications Centre, 7-10 (1994)
5. British Standard BS EN ISO 140-4:1998, Acoustics —Measurement of sound insulation in buildings and of building elements — Part 4: Field measurements of airborne sound insulation between rooms, BSI 1-5 (1998).
6. British Standard BS EN ISO 140-7:1998, Acoustics —Measurement of sound insulation in buildings and of building elements — Part 7: Field measurements of impact sound insulation of floors, BSI 1-4 (1998).
7. Scottish Building Standards Agency, Noise, technical handbooks - domestic - for compliance with 'Building Scotland regulation', Stationery Office, 5.0-5.1 and 5A -5C (2007)