

Northumbria Research Link

Citation: Liu, Lei, Korolkiewicz, Edward, Ghassemlooy, Zabih, Sambell, Alistair, Danaher, Sean and Lu, Qing (2012) Effect of losses in an active device and harmonic network on the efficiency of Class F and inverse Class F power amplifiers. In: EFEA 2012: 2nd International Symposium on Environment Friendly Energies and Applications, 25-27 July 2012, Northumbria University, Newcastle upon Tyne, UK.

URL: <http://soe.unn.ac.uk/EFEA2012/> <<http://soe.unn.ac.uk/EFEA2012/>>

This version was downloaded from Northumbria Research Link:
<http://nrl.northumbria.ac.uk/id/eprint/8261/>

Northumbria University has developed Northumbria Research Link (NRL) to enable users to access the University's research output. Copyright © and moral rights for items on NRL are retained by the individual author(s) and/or other copyright owners. Single copies of full items can be reproduced, displayed or performed, and given to third parties in any format or medium for personal research or study, educational, or not-for-profit purposes without prior permission or charge, provided the authors, title and full bibliographic details are given, as well as a hyperlink and/or URL to the original metadata page. The content must not be changed in any way. Full items must not be sold commercially in any format or medium without formal permission of the copyright holder. The full policy is available online: <http://nrl.northumbria.ac.uk/policies.html>

This document may differ from the final, published version of the research and has been made available online in accordance with publisher policies. To read and/or cite from the published version of the research, please visit the publisher's website (a subscription may be required.)



**Northumbria
University**
NEWCASTLE



UniversityLibrary

Effect of Losses in an Active Device and Harmonic Network on the Efficiency of Class F and Inverse Class F Power Amplifiers

L. Liu, *Student Member, IEEE*, E. Korolkiewicz, *Fellow, IET*, Z. Ghassemlooy, *Senior Member, IEEE*, A. Sambell, *Member, IEEE*, S. Danaher, *Member, IEEE*, and Q. Lu, *Student Member, IEEE*

Email: lei.liu@northumbria.ac.uk

Abstract- High frequency class F and inverse class F power amplifiers obtain high efficiency of dc to ac power conversion, by reducing the overlap of voltage and current waveforms at the output of the active device, to ensure that the power dissipated in the resistance R_{on} of the active device is minimised. In this paper the active device is modelled as a switch in series with resistance R_{on} 0 to 5 Ω . For ideal switch voltage / current waveforms and equal dc input power for both amplifiers the efficiency of power conversion is compared. To confirm the predicted results ideal lossless load harmonic networks using lumped elements were designed to meet all frequency conditions of the two amplifiers. These networks were done used in Advanced Design System (ADS) software for R_{on} =0, 2 and 4 Ω . The predicted efficiency for 2 Ω and 4 Ω were 80% and 60% and the obtained simulation efficiency were 83.2% and 65.5% for class F amplifier. For the inverse class F amplifier the predicted efficiency was 87.3% and 74.5% and for the simulation results it was 87.26% and 74.4%. Above predicted and simulated results show that the resistance R_{on} has less effect on the efficiency of inverse class F than for class F amplifier. As lumped elements can not be used at high frequencies they were replaced initially with lossless transmission lines and then by microstrip lines to also investigate also how copper and dielectric losses affect the efficiency of power conversion.

Key words- high efficiency power amplifier, class F and inverse class F power amplifier, harmonic matching

I. INTRODUCTION

There is an increasing demand for low cost mobile communication systems and battery operated radio receivers where high efficient power amplifiers are used. The main objective in the design of these amplifiers is to produce high efficiency conversion of dc energy supplied by the battery to ac energy that is used in the transmitter part of the above systems. If high efficiency is obtained there is considerable reduction of dissipated power consumption which becomes increasing important as the use of these systems is increasing not only in developed, but also in emerging countries. This increase in efficiency also addresses the current the problem of saving global energy. For an ideal class F amplifier [1]-[3] load harmonic network ensures that only odd harmonics are present in the voltage and only even harmonics are present in the current waveforms at the output terminals of the active deice. For the above conditions square voltage and half-sinusoidal current waveforms are obtained at the active device. For R_{on} equal to zero these ideal waveforms do not overlap and hence 100% dc to ac power conversion can theoretically be obtained. Similarly for the ideal inverse class F amplifier

[4]-[6] the harmonic network produces square current and half-sinusoid voltage waveforms and again 100% dc to ac power conversion can also be obtained if R_{on} is equal to zero.

In [7] the losses in R_{on} were investigated where it was assumed that the output powers were the same for the two amplifiers and to solve the obtained complex equations required the use of MachCAD software. In this paper the solution of the derived equations is considerably simplified by assuming that the input power to the two amplifiers is the same. The theoretical derived equations were then used to compare the efficiency of power conversion for the two amplifiers. The theoretically predicted results for R_{on} equal to 0, 2 and 4 Ω were compared with results obtained by simulation using ADS software where ideal lossless transmission lines were used. Then the ideal transmission lines were replaced by microstrip lines so that the effect of substrate and copper losses on the efficiency of power conversion for both amplifiers could also be compared.

II. EFFECT R_{on} ON THE EFFICIENCY OF POWER CONVERSION FOR CLASS F AND INVERSE CLASS F POWER AMPLIFIERS

For the two amplifiers the ideal voltage and current waveforms at the output terminals of the active device are shown below.

In deriving the below equation it was assumed same dc voltage v_{DD} is used in both amplifiers. For the class F amplifier using Fourier series expansion for the above waveforms equations for dc input power P_{dcF} , output power P_{oF} at design frequency, impedance R_{LF} at the design frequency (see Fig. 2) and efficiency of power conversion η_F shown below were derived. In the below equations v_k is the knee voltage of the output characteristics of the active device and given by $v_k = i_{pF} * R_{on}$

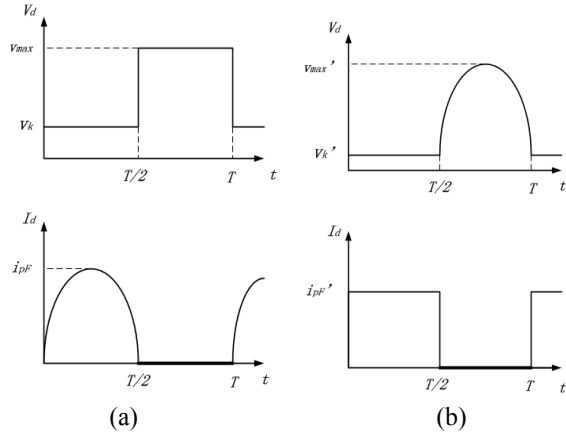

Fig. 1 Ideal voltage and current wave forms at the output of the active device (a) Class F (b) Inverse class F

$$P_{dcF} = \frac{V_{DD} i_{pF}}{\pi} \quad (1a)$$

$$P_{oF} = \frac{(V_{DD} - v_k) i_{pF}}{\pi} \quad (1b)$$

$$R_{LF} = \frac{8(V_{DD} - v_k)}{\pi i_{pF}} \quad (1c)$$

$$\eta_F = \frac{V_{DD} - v_k}{V_{DD}} \quad (1d)$$

The corresponding equations for the inverse class F amplifier are shown below.

$$P_{dcF'} = \frac{V_{DD} i_{pF'}}{2} \quad (2a)$$

$$P_{oF'} = \frac{(V_{DD} - v_{k'}) i_{pF'}}{2} \quad (2b)$$

$$R_{LF'} = \frac{\pi^2 (V_{DD} - v_{k'})}{4 i_{pF'}} \quad (2c)$$

$$\eta_{F'} = \frac{V_{DD} - v_{k'}}{V_{DD}} \quad (2d)$$

The performance of the two amplifiers can be compared by deriving equations for the inverse class F amplifier in terms of the design parameters of the class F amplifier. This is obtained by ensuring that the dc input power for both amplifiers is the same so that the current $i_{pF'}$ can be expressed in terms of i_{pF} , as shown in equation (3) by using equations 1(a) and 2(a).

$$i_{pF'} = \frac{2i_{pF}}{\pi} \quad (3a)$$

The knee voltage $v_{k'}$ for the inverse class F is obtained in terms of i_{pF} as shown in equation 3(b) and as can be seen v_k is less than $v_{k'}$.

$$v_{k'} = i_{pF'} R_{on} = \frac{2i_{pF}}{\pi} R_{on} \quad (3b)$$

Similarly $R_{LF'}$ in equation 2(c) is given by equation (4) below.

$$R_{LF'} = \frac{\pi^3 (V_{DD} - \frac{2i_{pF}}{\pi} R_{on})}{8i_{pF}} \quad (4)$$

For the derived equations 1(c), (3b) and (4) the output characteristic of an active device are shown in Fig. 2.

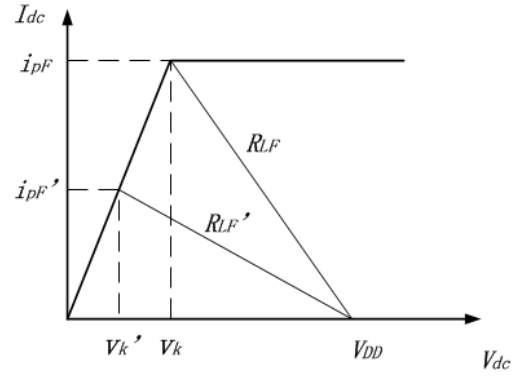

Fig. 2 Output characteristic of the active device

To compare the efficiencies of the two amplifiers the following modified equations for inverse class F amplifier can be obtained by using equations (3a), in equations (2c) and (2d).

$$P_{oF'} = \frac{(V_{DD} - \frac{2i_{pF}}{\pi} R_{on}) i_{pF}}{\pi} \quad (5a)$$

$$\eta_{F'} = \frac{V_{DD} - \frac{2i_{pF}}{\pi} R_{on}}{V_{DD}} \quad (5b)$$

Assuming that for $V_{DD} = 5V$ and $i_{pF} = 0.5 A$, the input dc power given by equation 1(a) is 0.796 watts and the effect of R_{on} (0 to 5ohms) on the out output power for the two amplifiers using equations (1b) and (2b) are shown Fig. 3(a) below. Fig. 3(b) shows how the load resistances R_L and $R_{LF'}$ and Fig. 3(c) shows how the efficiencies of the two amplifiers are affected by R_{on} .

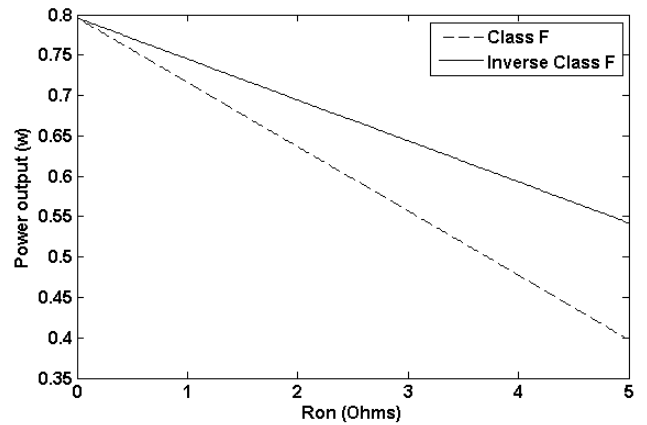

(a)

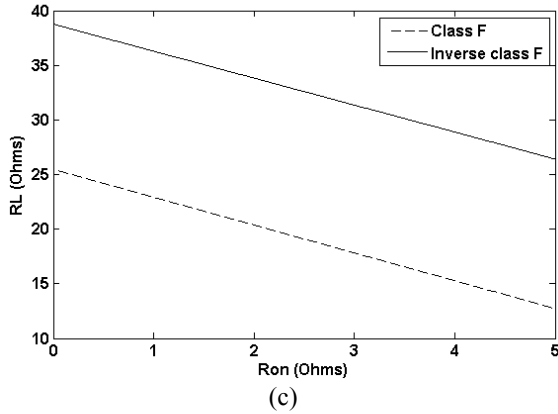
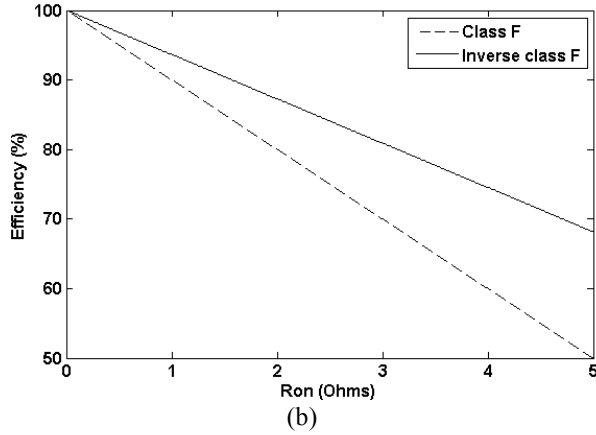

Fig. 3 Effect of R_{on} on (a) Power output (b) Dc to ac power conversion efficiency (c) Load resistance

Fig. 3 (b) shows that the efficiency reduces as a function of R_{on} but this reduction is larger for class F amplifier than it is for the inverse class F amplifier. For $R_{on} = 2\Omega$ the power the conversion efficiency is 87.3% for inverse class F and 80% for class F amplifier. The resistances shown on Fig. 3(c) will be used to design the load harmonic networks for the two amplifiers as discussed in the next section.

III. INVESTIGATION OF THE WAVEFORMS AND EFFICIENCY OF POWER CONVERSION OF THE TWO AMPLIFIERS USING ADS SOFTWARE

The block diagram of the above amplifiers is shown in Fig. 4 where the active device is modelled as an ideal switch in series with R_{on} and Z_{in} is the input impedance of the load harmonic network. For the class F amplifier the input impedance of the load harmonic at fundamental frequency $Z_{in}(f) = R_{LF}$, for even harmonic $Z_{in}(2nf) = 0$, for odd harmonic $Z_{in}((2n+1)f) = \infty$, where $n=1,2,3\dots$. For the inverse class F amplifier, the input impedance at fundamental frequency $Z_{in}(f) = R_F$, for even harmonic $Z_{in}(2nf) = \infty$, for odd harmonic $Z_{in}((2n+1)f) = 0$. These conditions ensure that the ideal voltage and current waveforms shown below are obtained.

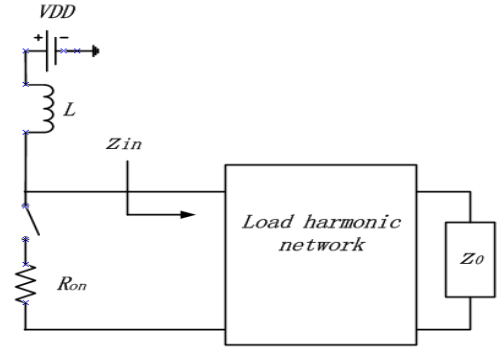

Fig. 4 Block diagram of a high efficiency amplifier

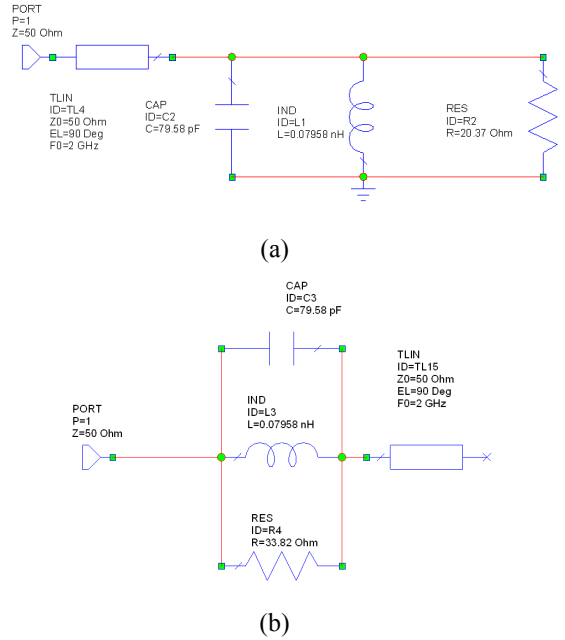
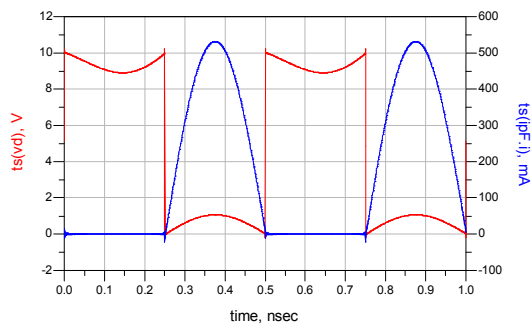

Fig. 5 Ideal harmonic matching networks for all frequency (a) Class F (b) Inverse class F

To confirm the above predicted results the ideal load harmonic networks for both amplifiers are shown in Fig. 5. The required input impedance of the two networks at 2 GHz using equations 1(c) and (4) are $R_{LF} = 20.37\Omega$ and $R_{LF} = 33.82\Omega$. The networks also satisfy the required input impedance at all the harmonics that are required to obtain the square and half sinusoidal waveforms.

The above networks were used in ADS software and the obtained switch voltage and current waveforms for the two amplifiers are shown in Fig. 6. For the inverse class F amplifier the predicted waveforms shown in Fig. 6(b) are very similar to those predicted waveforms shown in Fig. 1(b). However there is a small difference between the predicted and obtained waveforms for the class F amplifier (see Fig.1(a)) and Fig. 6(a)) which due to the resistance R_{on} .



(a)

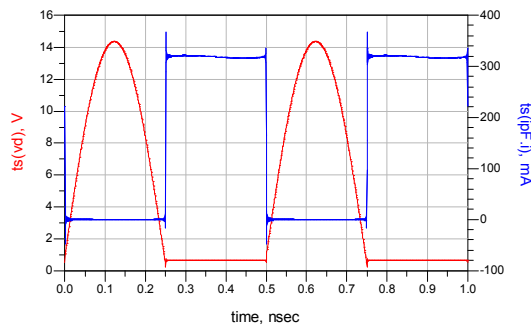

(b)

Fig. 6 Voltage and current wave forms through ideal switch and internal resistance R_{on} by ADS simulation for infinity number harmonic (a) Class F amplifier (b) Inverse class F amplifier

For high frequency power amplifier it is practically not possible to use lumped reactive circuit element which must be replaced by transmission lines. For this reason it is not possible nor is it desirable to design these load harmonic networks to satisfy the required conditions at all the harmonics. Such a network would require an infinite number of microstrip lines producing large losses which would cause the efficiency of power to conversion to reduce. Normally these networks are designed to obtain the desired input impedances at the design frequency and at the next two harmonics. The designed load harmonic networks up to the third harmonic are shown in Fig. 7 below for $R_{on} = 2\Omega$. The obtained simulated voltage and current waveforms for the two amplifiers shown in Fig. 8.

The effect of using load harmonic networks designed up to the third harmonic using lossless transmission lines (TLin) and microstrip lines (MLin) where there are copper and dielectric losses are compared with the infinity number of harmonic results and shown in table 1 below for $R_{on} = 0, 2$ and 4Ω .

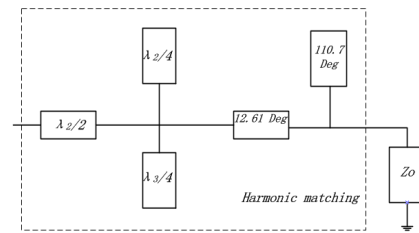

(a)

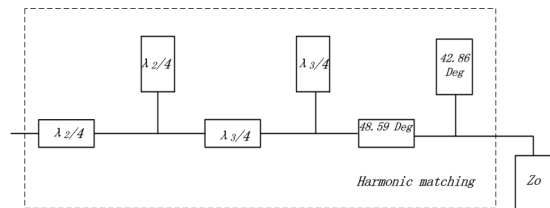

(b)

Fig. 7 Harmonic matching networks (a) Class F (b) Inverse class F

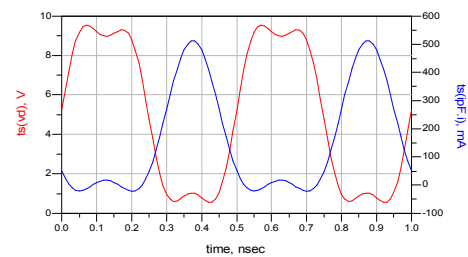

(a)

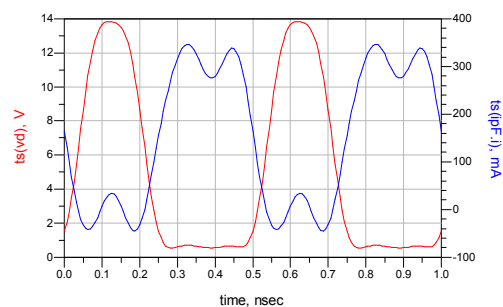

(b)

Fig. 8 Voltage and current wave forms through ideal switch and internal resistance R_{on} by ADS simulation up to 3rd harmonic (a) Class F amplifier (b) Inverse class F amplifier

Table I

Infinity number harmonics					
		Predicted results		ADS results	
Ron	Class F	Inverse class F	Class F	Inverse class F	
0	100%	100%	99.90%	99.90%	
2	80%	87.30%	83.20%	87.26%	
4	60%	74.50%	65.50%	74.40%	
Up to 3rd harmonics					
		TLin Model		MLin Model	
Ron	Class F	Inverse class F	Class F	Inverse class F	
0	99.00%	99.10%	75.28%	88.31%	
2	81.70%	87.00%	62.70%	77.60%	
4	64.40%	73.10%	49.89%	67%	

Table 1 shows that for both amplifiers that the efficiency reduces as R_{on} increases but however this reduction is larger for class F amplifier than it is for the inverse class F amplifier. Microstrip line also causes the loss and efficiency drops more than 5 % for both amplifiers and more effects on class F as well.

IV. CONCLUSIONS

The effect of losses on the efficiency of dc to ac power conversion in R_{on} and in microstrip lines used in load harmonic networks, are compared for class F and inverse class F power amplifiers. Initially assuming ideal voltage and current waveforms design equations were derived for both amplifiers. Then applying the condition that the dc input power is the same for both amplifiers it was shown that for the range of resistance R_{on} 0 to 5Ω , the obtained efficiency of power conversion of the inverse class F amplifier is better than it is for the class F amplifier. In practice however such ideal voltage and current waveforms cannot be practically obtained. A more realistic comparison can be made by using ADS software, where the active device is modelled as an ideal switch in series with R_{on} (0 to 5Ω) and a suitable load harmonic network, to obtain the current and voltage waveforms and efficiency of power conversion for R_{on} 0 to 5Ω . In this modelling to ensure that the dc input power was the same for both amplifiers the input impedance of both harmonic matching networks was the same as those derived by the design equations. Initially these load harmonic networks were designed using lumped reactive elements to meet the required conditions at each harmonic of the current and voltage waveforms. However in practice the above lump elements cannot be used and hence they were replaced by ideal lossless transmission lines and by microstrip lines to meet the required conditions at the design frequency and the first two harmonics. From the obtained results, for the above load harmonic networks, it is shown that the obtained efficiency is always better for the inverse class F amplifier than that of the class F amplifier.

REFERENCES

- [1] S. F. Ooi, S. Gao, A. Sambell, D. Smith, and J. Butterworth, "High efficiency class-F power amplifier design," 2004 High Frequency Postgraduate Student Colloquium, pp. 113-118 211, 2004.
- [2] H. C. Park, G. H. Ahn, S. C. Jung, C. S. Park, W. S. Nah, B. S. Kim, and Y. G. Yang, "High-efficiency class-F amplifier design in the presence of internal parasitic components of transistors," 2006 European Microwave Conference, Vols 1-4, pp. 1055-1058, 2006.
- [3] D. Schmelzer and S. I. Long, "A GaNHEMT Class F amplifier at 2 GHz with > 80 % PAE," IEEE Compound Semiconductor Integrated Circuit Symposium - 2006 IEEE Csic Symposium, Technical Digest 2006, pp. 96-99, 2006.
- [4] Y. J. Xu, J. Q. Wang, and X. W. Zhu, "Analytical Design of an Inverse Class F Power Amplifier for Linear Amplification," Microwave Journal, vol. 54, pp. 146-+, May 2011.
- [5] P. Aflaki, R. Negra, and F. M. Ghannouchi, "Design and implementation of an inverse class-F power amplifier with 79 % efficiency by using a switch-based active device model," 2008 IEEE Radio and Wireless Symposium, Vols 1 and 2, pp. 423-426, 2008.
- [6] H. J. Kim, G. W. Choi, and J. J. Choi, "A high-efficiency inverse class-F power amplifier using GaNHEMT," Microwave and Optical Technology Letters, vol. 50, pp. 2420-2422, Sep 2008.
- [7] Y. Y. Woo, Y. Yang, I. Kim, and B. Kim, "Efficiency comparison between highly efficient class-F and inverse class-F power amplifiers," IEEE Microwave Magazine, vol. 8, pp. 100-+, Jun 2007.