

Northumbria Research Link

Citation: Herbertson, Dale, Evans, Carl, Shirtcliffe, Neil, McHale, Glen and Newton, Michael (2006) Electrowetting on superhydrophobic SU-8 patterned surfaces. *Sensors and Actuators A: Physical*, 130-1. pp. 189-193. ISSN 0924-4247

Published by: Elsevier

URL: <http://dx.doi.org/10.1016/j.sna.2005.12.018>
<<http://dx.doi.org/10.1016/j.sna.2005.12.018>>

This version was downloaded from Northumbria Research Link:
<http://nrl.northumbria.ac.uk/id/eprint/8325/>

Northumbria University has developed Northumbria Research Link (NRL) to enable users to access the University's research output. Copyright © and moral rights for items on NRL are retained by the individual author(s) and/or other copyright owners. Single copies of full items can be reproduced, displayed or performed, and given to third parties in any format or medium for personal research or study, educational, or not-for-profit purposes without prior permission or charge, provided the authors, title and full bibliographic details are given, as well as a hyperlink and/or URL to the original metadata page. The content must not be changed in any way. Full items must not be sold commercially in any format or medium without formal permission of the copyright holder. The full policy is available online: <http://nrl.northumbria.ac.uk/policies.html>

This document may differ from the final, published version of the research and has been made available online in accordance with publisher policies. To read and/or cite from the published version of the research, please visit the publisher's website (a subscription may be required.)

Postprint Version

D.L. Herbertson, C.R. Evans, N.J. Shirtcliffe, G. McHale and M.I. Newton, *Electrowetting on superhydrophobic SU-8 patterned surfaces*, Sens. Act. A. 130 (SI) (2006) 189-193; DOI: 10.1016/j.sna.2005.12.018.

The following article appeared in [Sensors and Actuators A](#) and may be found at <http://dx.doi.org/10.106/j.sna.2005.12.018>. Copyright ©2005 Elsevier B.V.

**ELECTROWETTING ON SUPERHYDROPHOBIC SU-8
PATTERNED SURFACES**

Dale L. Herbertson, Carl R. Evans, Neil J. Shirtcliffe,
Glen McHale and Michael I. Newton^{*}

School of Biomedical and Natural Sciences,
Nottingham Trent University,
Clifton Lane,
Nottingham NG11 8NS UK

^{*}Corresponding author: michael.newton@ntu.ac.uk; tel: +44 115 8483365; fax: +44 115 8486636

Abstract

Electrowetting on micro-patterned layers of SU8 photoresist with an amorphous Teflon[®] coating has been observed. The cosine of the contact angle is shown to be proportional to the square of the applied voltage for increasing bias. However, this does not apply below 40V and we suggest that this may be explained in terms of penetration of fluid into the pattern of the surface. Assuming that the initial application of a bias voltage converts the drop from Cassie-Baxter to Wenzel regime, we have used this as a technique to estimate the roughness factor of the surface.

Keywords: Electrowetting; SU8; Superhydrophobic; Wenzel; Cassie-Baxter

INTRODUCTION

A small droplet of a liquid deposited on a surface either forms a spherical cap shape with a well-defined equilibrium contact angle θ to the solid or it spreads across the surface until it forms a wetting film. The precise equilibrium that results is determined by a balance between the interfacial forces for the solid-liquid (γ_{SL}), liquid-vapour (γ_{LV}) and solid-vapour (γ_{SV}) interfaces. This equilibrium can be ascribed to the balancing of the relative interfacial contact areas (A_{SL} , A_{LV} and A_{SV}), given the interfacial tensions for a particular solid-liquid-vapour system, so as to minimise the surface free energy [1-3].

Super-hydrophobicity and electrowetting both modify the effective contact angle by altering the balance of surface free energy without altering the chemically determined interfacial energies. In current approaches to superhydrophobicity, the solid surface is physically structured through either patterning or roughness such that the ratio of actual surface area to the geometric (horizontally projected) surface area r is greater than 1 [4]. Wenzel's equation, $\cos\theta_r = r\cos\theta_e$ gives the equilibrium contact angle on the rough surface θ_r as a function of the contact angle on a flat surface θ_e and the surface roughness r , provided intimate contact is maintained between the solid and the liquid. Wenzel's equation predicts that the basic wetting behavior of a surface will be enhanced by roughness so that roughness on a surface with $\theta_e > 90^\circ$ will result in a larger angle and roughness on a surface with $\theta_e < 90^\circ$ will result in a smaller angle. In practice, intimate contact is not usually maintained on high roughness hydrophobic surfaces, unless hydrostatic pressure is applied, and the liquid drop effectively sits upon a composite surface of the peaks of the topography and the air separating the surface features so that Cassie-Baxter equation applies $\cos\theta_r = f\cos\theta_e - (1-f)$ where f is the fraction of the area covered by the pattern. Nonetheless, it is possible to generate surfaces that are super-hydrophobic ($\theta \geq 150^\circ$) and one of the key differences to the predictions from Wenzel's equation is that the effect of roughness on surfaces will be to further emphasize super-hydrophobicity; the contact angle for which roughness causes increases in apparent contact angle will be reduced below 90° .

In electrowetting, the solid surface upon which the liquid drop rests is a thin electrical insulator layer of thickness d coating an underlying conducting surface [5]. Thus, a slightly conductive droplet creates a capacitance defined by the contact area of the droplet and the substrate. When a voltage, V , is applied between the conductor and insulator an electric charge is created and this alters the surface free energy balance. The additional energy per unit area due to the capacitance is given by $\frac{1}{2}CV^2$ where for a simple planar surface the capacitance per unit area is $C=\epsilon_r\epsilon_0/d$. It is found that on a flat surface the equilibrium contact angle for a given voltage is given by the expression $\cos\theta_e(V) = \cos\theta_e + CV^2/(2\gamma_{LV})$. The prediction of this equation is that a voltage will cause the contact angle of a droplet to decrease so that a reduction in hydrophobicity occurs. This effect is seen in practice although hysteresis is often observed; because the effect is capacitive, either a dc or ac voltage can be used. From the above description of super-hydrophobicity and electrowetting, it appears that these two mechanisms are complementary with one providing an increase in hydrophobicity and the other a reduction simultaneously applicable to a single surface. In a recent report of electrowetting on nanostructured surfaces [6] it was demonstrated that dynamic electrical control of the wetting behavior of liquids could be achieved from superhydrophobicity to almost complete wetting. In this work we report studies of electrowetting on superhydrophobic surfaces of micro-patterned SU-8 photoresist structures.

EXPERIMENTAL

SU-8 is an epoxy based negative photo-resist that can be used to fabricate thick patterns with smooth walls and which is strong, stiff and chemically resistant after processing. The properties of SU-8 also make it suitable for making super-hydrophobic surfaces in the form of arrays of pillars. Hydrophobic SU-8 surfaces with high aspect ratio patterns become super-hydrophobic. Substrates were prepared by initially coating a glass cover slip with an 8nm layer of Ti followed by a 40 nm layer of Au by sputter coating. SU-8 was deposited on top and patterned in the form of circular pillars as described previously [7]. The patterned SU-8 was spin coated with amorphous

fluoropolymer Teflon[®] AF 1600 (DuPont Polymers). The completed structure consisted of cylindrical pillars of diameter (7.0 ± 0.5) μm with a centre to centre separation of 15 μm and with height of (6.5 ± 1.3) μm and on a base layer of approximately 8.5 μm confirmed by scanning electron microscope images and shown in Fig. 6. Droplets of deionised water with 0.01M KCl were deposited from a syringe and a solid metal wire brought into contact with the drop as shown in Fig. 1; the drop volume was restricted to the range where gravity is not significant. The profile of the drop was captured and analysed using the drop shape analysis software on a Kruss DSA-1 contact angle meter. A dc voltage was applied using a Keithley 2410 source/meter under the control of a microcomputer. Surface profiles were measured after experimentation by gold coating and monitoring in a SEM.

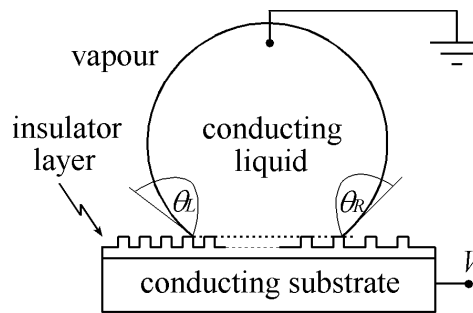

Fig. 1. Experimental arrangement for electrowetting.

RESULTS AND DISCUSSION

In Fig. 2 we show the drop images for a drop of water immediately after deposition (upper image), at the maximum voltage applied of 130V (middle image) and at zero volts after the bias had been removed (bottom image). One feature that is clearly observed is the high hysteresis in the contact angle. In Fig. 3 we show the change in the cosine of the contact angle as a function of the square of the applied bias voltage; the seep time for a voltage cycle was 260 seconds representing 5 volt steps with a 5 second settling time before measurement. From the simple theory, based on a planar surface, we would expect a reversible change in contact angle as the voltage was applied then removed. However, in this experiment the starting contact angle is 152° and, after a cycle from zero volts up to 130 V and back to zero, the contact angle has

reduced to 114° . Figure 3 clearly shows that there is no reversibility and that the contact angle continues to fall even as the voltage is decreased. Although in Fig. 3 low bias voltages do not produce a linear change, from 70 V up to the maximum voltage a good fit to a straight line is observed. Figure 4 shows the change in base diameter, defined as the length of the macroscopic contact line between liquid and solid, as a function of applied voltage. For values of bias up to 45 V little change is observed in the base diameter. This suggests that under the effect of the applied bias, liquid is being drawn into the pattern and that the drop is changing from the Cassie-Baxter to the Wenzel regime.

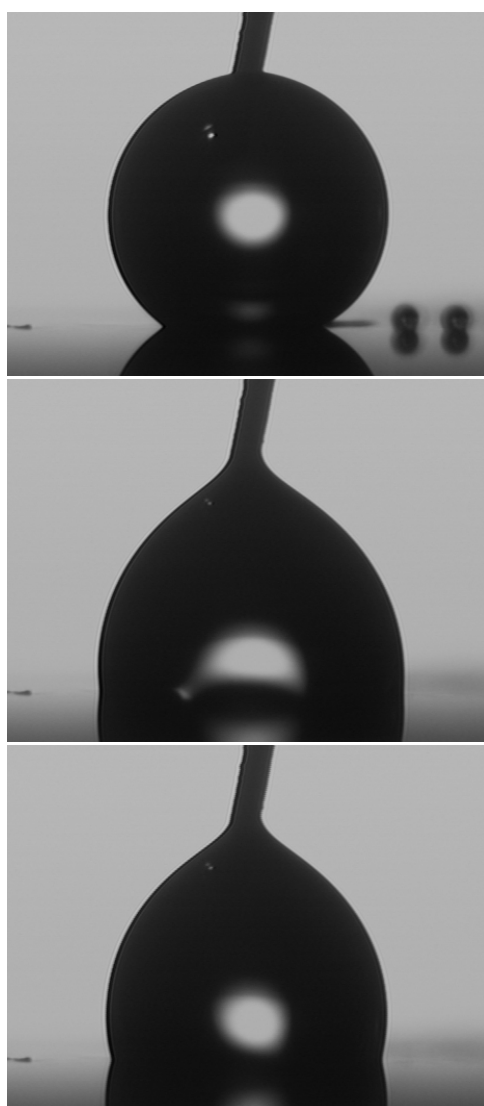

Fig. 2. Image of a water drops on a SU-8 patterned surface with a Teflon[®] AF overlayer showing the Initial drop (upper), drop with maximum applied voltage (centre) and drop with voltage removed (lower).

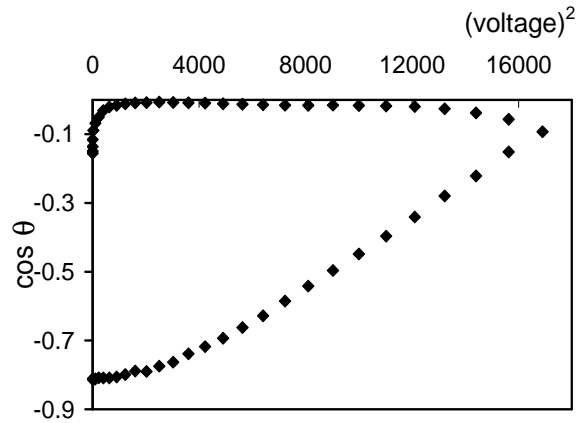

Fig. 3. The cosine of the contact angle (θ) as a function of the square of the applied voltage (V^2) showing the increasing voltage starting at $\cos \theta = -0.812$.

If this is the case then we should expect that the linear region of Fig. 3 should allow us to predict the roughness factor of the pattern given a known contact angle on a flat surface. In addition, if the water enters the pattern we would expect it to follow the Wenzel model and recent work has suggested that high contact angle hysteresis would be expected for such a system [3]. For the voltage range following the threshold voltage at which a conversion from a Cassie-Baxter to the Wenzel state occurs, we use a fitting parameter V_0 and plot $\cos \theta$ as a function of $(V - V_0)^2$ adjusting the V_0 to give the best fit; from this fit the intercept should give the cosine of the Wenzel angle θ_r . The presence of a constant V_0 occurs in the classical derivation for electrowetting of a dipolar liquid directly on a metal surface due to the creation of a charge double layer [8]; the offset voltage V_0 is required to overcome the spontaneous charging that appears at zero voltage. However, in our case we have an insulating layer of SU8 between the liquid and the metal electrode and the situation more closely resembles the work of Verheijen and Prins [9] who use a flat insulating layer on a metal substrate. They suggest that when a potential is applied there is a possibility that charge becomes trapped in or on the insulating layer. They show that the effect of this trapped charge is similar to the classical case and also gives the cosine of the contact angle proportional to $(V - V_0)^2$. In our experiments, we have the additional complication of an enhanced solid-liquid interfacial area due to the patterning of the substrate and this means the intercept in the fit provides the cosine of the Wenzel angle, which takes into account surface roughness.

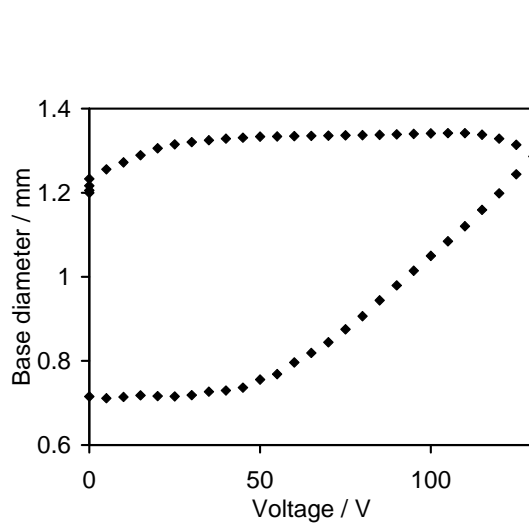

Fig. 4. The base diameter as a function of the square of the applied voltage.

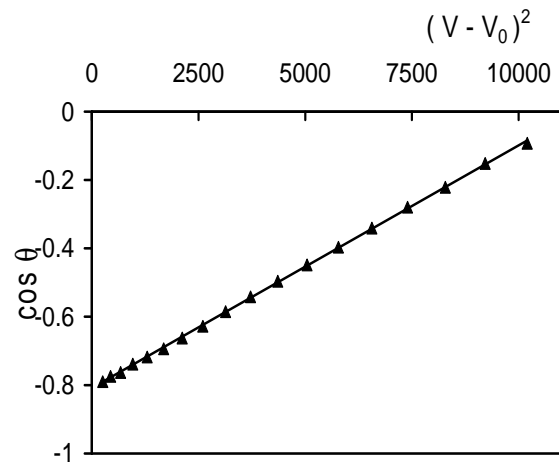

Fig. 5. The cosine of the contact angle (θ) as a function of $(V - V_0)^2$ where V is the applied voltage and fitting parameter $V_0 = 28$ volts.

In Fig. 5 we show this for the voltage range from 45 to 130 volts. The data gives an $R^2=0.9998$ fit for $V_0 = (28 \pm 1)$ V which corresponds to a θ_r from the intercept of $143.3^\circ \pm 0.4^\circ$. A measurement of the contact angle on a flat surface treated with the Teflon[®] AF gives $\theta_e = 113.9^\circ$. Using Wenzel's equation and the derived value for θ_r , this gives a roughness factor of 1.92 ± 0.1 . As the pattern is a replication of a circular pillar of diameter (7.0 ± 0.5) μm and estimated height of (6.5 ± 1.3) μm within a box of sides $15 \mu\text{m} \times 15 \mu\text{m}$, the roughness factor is $r = 1.64 \pm 1.7$. The slight difference in these values may be explained from the electron microscope image shown in Fig. 6; the arrow in this diagram represents $20 \mu\text{m}$. This clearly shows Teflon[®] from the spin coating process acting as bridges between the pillars. These bridges will be adding an extra contribution to the surface roughness, which is not reflected in the simple area calculation. Fig. 7 shows a simple model for the extra surface area introduced by a single bridge between pillars in the spin direction. If the diameter of the pillars is taken as (7.0 ± 0.5) μm and the average height (6.5 ± 1.3) μm with the bridge being half the height of the pillar, the new roughness factor becomes $r=1.87 \pm 0.2$, which is in close agreement with the value estimated from Fig. 5.

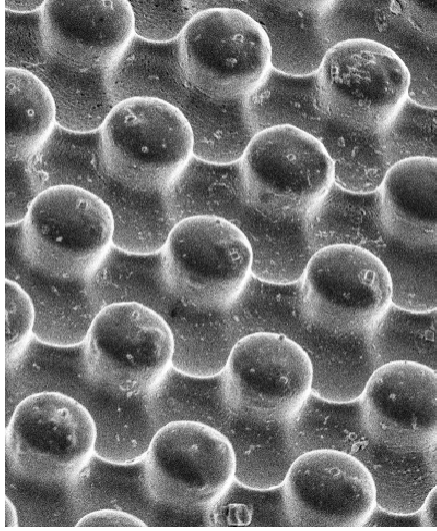

Fig. 6. Scanning electron microscope image of patterned surface with Teflon AF coating; the arrow represents 20 μm .

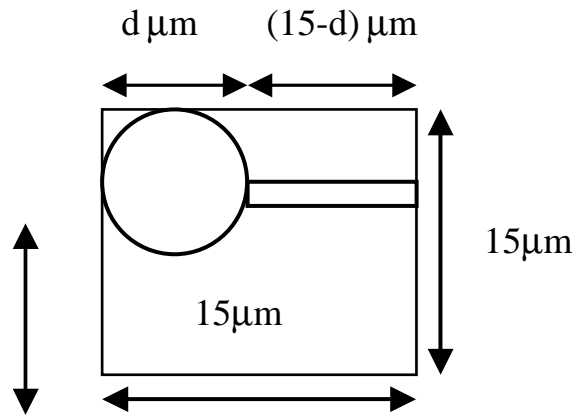

Fig. 7. Revised model for roughness calculation with pillar of height h and diameter d and single bridge of height $h/2$.

For a simple electrowetting model the gradient of the line in Fig. 5 should be equal to $C/(2\gamma_{LV})$ where C is the capacitance per unit area. Treating the pillars and troughs as two capacitors in parallel with f the fraction of the area occupied by the pillars, we can write the gradient as equal to $[(\epsilon_0\epsilon_r)/(2\gamma_{LV})][f/d_1+(1-f)/d_2]$ where d_1 is the height from the gold layer to the top of the pillars and d_2 the height from the gold to the bottom of the trough. Estimating values for d_1 and d_2 is complicated by the extra structure on the AF1600 coating in the gaps between the pillars. However, estimating a range of values for d_1 and d_2 and taking $f=0.15$, $\gamma_{LV}=72.8 \text{ mN m}^{-1}$ and $\epsilon_r=3$ gives a gradient of between 10^{-4} and $10^{-5} \text{ (V}^2\text{)}$ which gives the correct order of magnitude as the gradient from Fig. 5 of $7.0 \times 10^{-5} \text{ (V}^2\text{)}$.

CONCLUSION

Electrowetting on patterned layers of SU8 photoresist with an amorphous Teflon[®] coating has been observed. The data presented suggests that, on application of a bias voltage, water is initially drawn into the pattern converting from a Cassie-Baxter to Wenzel regime. Beyond the voltage at which the base

diameter begins to change, the cosine of the contact angle becomes proportional to the square of the applied voltage less a constant. From the intercept we can estimate the Wenzel angle on the surface and hence deduce an estimate for the surface roughness. This estimate gives a figure too high for simple smooth pillars and this is confirmed by scanning electron microscopy where bridges are observed. A simple modification to the roughness model to take account of the extra surface area brings the roughness factor in line with the electrowetting data.

ACKNOWLEDGEMENTS

The authors acknowledge the financial support of UK EPSRC and MOD/Dstl (GR/S34168/01 and EP/C509161/1).

REFERENCES

- [1] P.G. de Gennes, *Wetting – statics and dynamics*. Rev. Mod. Phys. 57 (1985) 827-863
- [2] L. Léger and J.F. Joanny, *Liquid spreading*. Rep. Prog. Phys. 55 (1992) 431-486
- [3] G. McHale, N.J. Shirtcliffe and M.I. Newton, *Contact angle hysteresis on super hydrophobic surfaces*. Langmuir 20 (2004) 10146-10149
- [4] T. Onda, S. Shibuichi, N. Satoh and K. Tsujii, *Super-water-repellent fractal surfaces*. Langmuir 12 (1996) 2125-2127
- [5] B. Berge, *Electrocapillarity and wetting of insulator films by water*. C.R. Acad.Sci. Paris II 317 (1993) 157-163
- [6] T.N. Krupenkin, J. Ashley Taylor, T.M. Schneider and S. Yang, *From rolling ball to complete wetting: The dynamic tuning of liquids on nanostructured surfaces*. Langmuir 20 (2004) 3824-3827
- [7] N.J. Shirtcliffe, S. Aqil, C. Evans, G. McHale, M.I. Newton, C.C. Perry and P. Roach, *The use of high aspect ratio photoresist (SU8) for super-hydrophobic pattern prototyping*. J. Micromech. Microeng. 14 (2004) 1384-1389
- [8] F. Mugele and J-C. Baret, *Electrowetting: from basics to applications*. J.Phys.:Condens. Matter 17 (2005) R705-R774
- [9] H.J.J. Verheijen and M.W.J. Prins, *Reversible electrowetting and trapping of charge: Model and experiments*. Langmuir 15 (1999) 6616-6620

Biographies

Dale Herbertson received a B.Sc. (Hons) degree in Chemistry at the University of Northumbria in 1991 and a Ph.D. in Materials Science at the University of Leeds in 2003. His Ph.D. research project was based on the fabrication and analysis of novel carbon-based double layer capacitors. He is currently working as an EPSRC research fellow at Nottingham Trent University where he is investigating the effects of electrowetting substances on superhydrophobic surfaces.

Carl Evans received a B.Sc. (Hons) degree in Physics in 2002 from Nottingham Trent University. He is currently studying for a Ph.D. in the School of Biomedical and Natural Sciences at Nottingham Trent University. His main research interests are in sensor applications of acoustic wave devices.

Neil Shirtcliffe received B.Sc. (Hons) and Ph.D. at Imperial College, London, England in 1993 and 1997 in Chemistry. His Ph.D. involved measuring electro-deposition of colloids using a QCM. He worked in Germany at the University of Nuremberg-Erlangen and the Max Planck Insitut fuer Eisenforschung in Duesseldorf on silver colloids and corrosion protection. He is now an EPSRC research associate at Nottingham Trent University, investigating the chemistry, physics and environmental effects of super-hydrophobicity.

Glen McHale received a B.Sc. (Hons) degree in Mathematical Physics in 1983 and a Ph.D. in 1986 in Applied Mathematics from The University of Nottingham. From 1986 to 1989, he was a Research Assistant in Physics at The University of Nottingham and from 1989 to 1990, he was a Royal Society European Research Fellow at Universite de Pierre et Marie Curie in Paris. He is currently a Professor in the School of Biomedical and Natural Sciences at Nottingham Trent University. His main research interests are in the field of wetting and the control of surface properties.

Michael Newton received a B.Sc. (Hons) degree in Physics in 1983, followed by a M.Sc. in Modern Electronics in 1985. In 1988, he received a Ph.D. for work on the interaction of acoustic waves with the two-dimensional electron gas in a Si MOSFET from The University of Nottingham. He is currently Reader in Experimental Physics in the School of Biomedical and Natural Sciences at Nottingham Trent University. His main research interests are in sensor applications of acoustic wave devices.

Figures

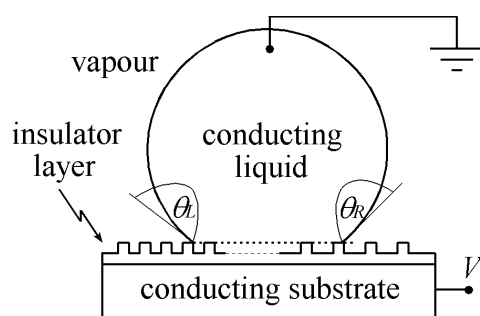

Figure 1 Experimental arrangement for electrowetting.

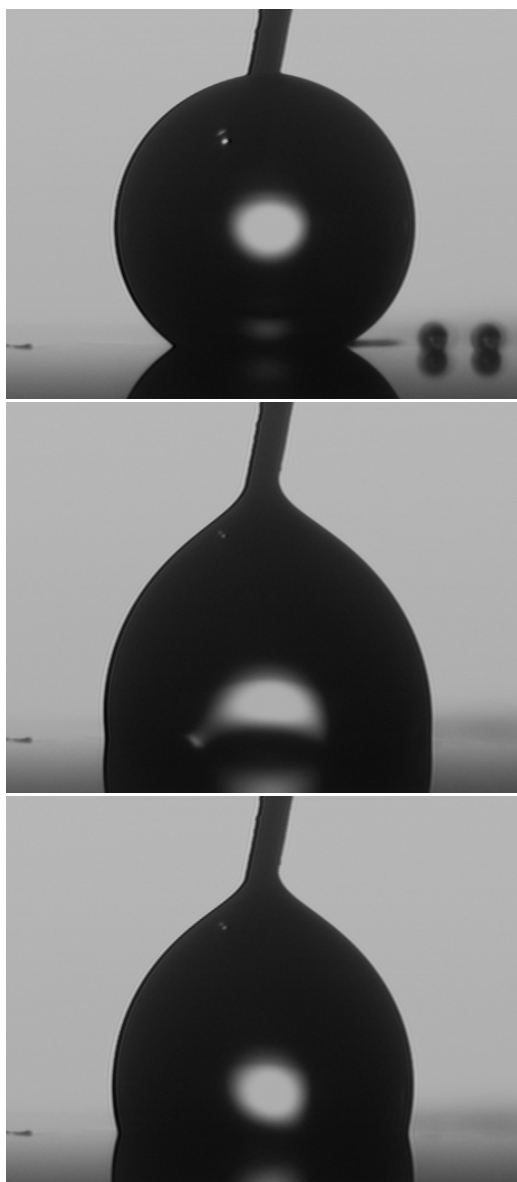

Figure 2. Image of a water drops on a SU-8 patterned surface with a Teflon[®] AF overlayer showing the Initial drop (upper), drop with maximum applied voltage (centre) and drop with voltage removed (lower).

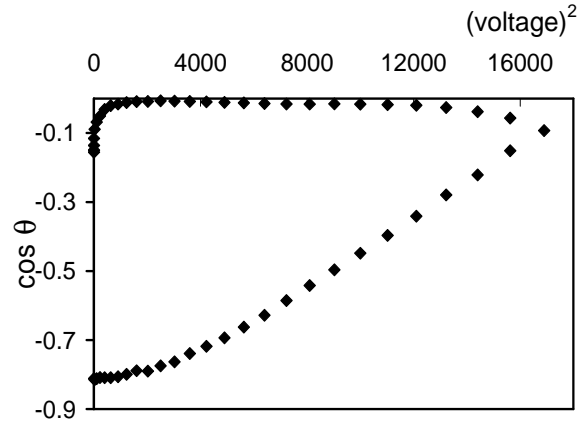

Figure 3. The cosine of the contact angle (θ) as a function of the square of the applied voltage (V^2) showing the increasing voltage starting at $\cos \theta = -0.812$.

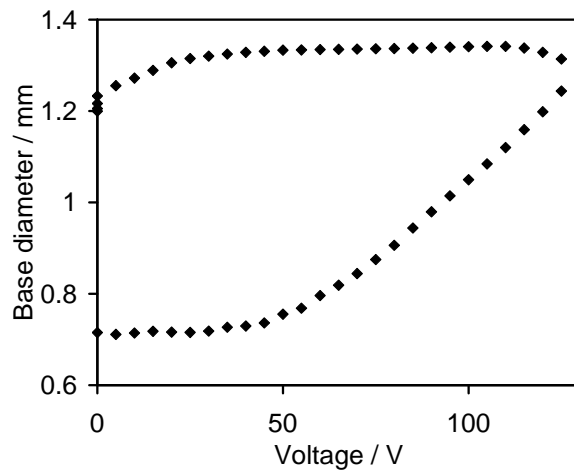

Figure 4. The base diameter as a function of the square of the applied voltage

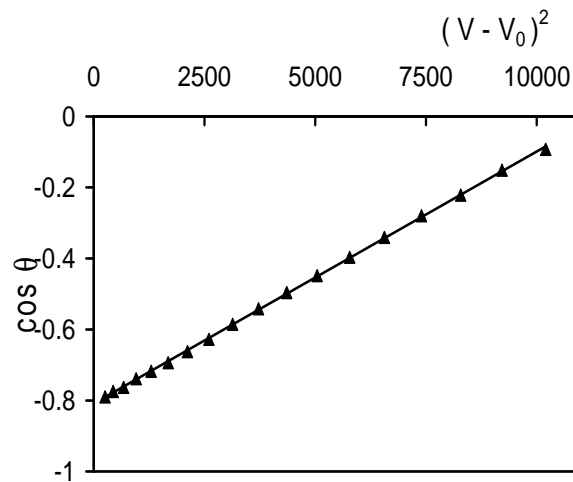

Figure 5. The cosine of the contact angle (θ) as a function of $(V - V_0)^2$ where V is the applied voltage and fitting parameter $V_0 = 28$ volts.

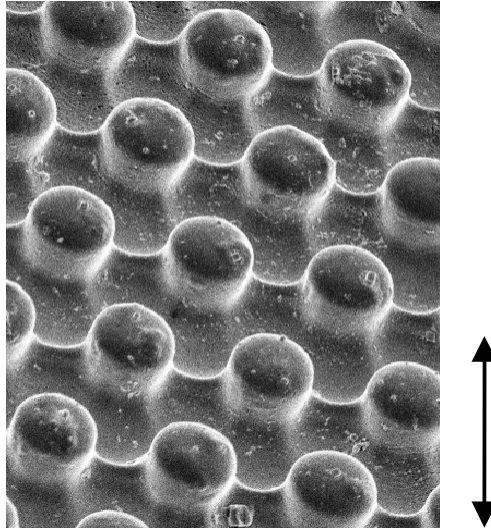

Figure 6. Scanning electron microscope image of patterned surface with Teflon AF coating; the arrow represents $20\ \mu\text{m}$.

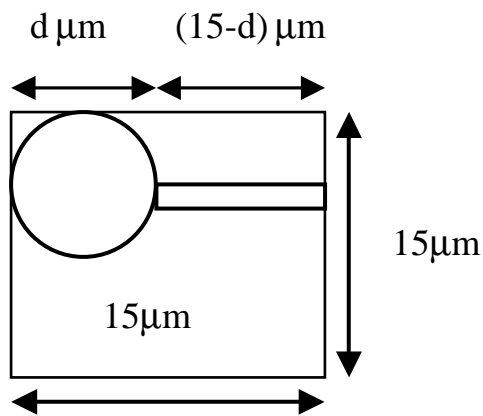

Figure 7. Revised model for roughness calculation with pillar of height h and diameter d and single bridge of height $h/2$.