

# Northumbria Research Link

Citation: Cuamba, Boaventura Chongo (1996) Studies of the performance of photovoltaic power plant in a Southern African environment. Doctoral thesis, University of Northumbria at Newcastle.

This version was downloaded from Northumbria Research Link:  
<https://nrl.northumbria.ac.uk/id/eprint/15672/>

Northumbria University has developed Northumbria Research Link (NRL) to enable users to access the University's research output. Copyright © and moral rights for items on NRL are retained by the individual author(s) and/or other copyright owners. Single copies of full items can be reproduced, displayed or performed, and given to third parties in any format or medium for personal research or study, educational, or not-for-profit purposes without prior permission or charge, provided the authors, title and full bibliographic details are given, as well as a hyperlink and/or URL to the original metadata page. The content must not be changed in any way. Full items must not be sold commercially in any format or medium without formal permission of the copyright holder. The full policy is available online: <http://nrl.northumbria.ac.uk/policies.html>

Some theses deposited to NRL up to and including 2006 were digitised by the British Library and made available online through the [EThOS e-thesis online service](#). These records were added to NRL to maintain a central record of the University's research theses, as well as still appearing through the British Library's service. For more information about Northumbria University research theses, please visit [University Library Online](#).



**Northumbria  
University**  
NEWCASTLE



University**Library**

**Studies of the Performance  
on a Photovoltaic Power Plant  
in a Southern African Environment**

**By**

**Boaventura Chongo Cuamba**

**A Thesis Submitted in Partial Fulfillment of the Requirements of the  
University of Northumbria at Newcastle for the Degree of  
Doctor of Philosophy**

**June 1996**

**University of Northumbria at Newcastle  
in Collaboration with the  
Eduardo Mondlane University  
and  
IT Power Ltd.**

## **Abstract**

The photovoltaic (PV) technology is now sufficiently mature so that it can play a significant role in providing energy services in rural and remote areas of developing countries. One of the key issues that deserves special attention in today's research is that of optimising the performance of systems based on this technology. Photovoltaic conversion of solar energy is intimately linked to the natural environment. Therefore, a good understanding of the effect of environmental parameters in situ upon the operation of the technology is essential for its efficient use. For this, monitoring of photovoltaic power plants is a prerequisite. In Europe, in the United States and in Japan extensive programmes of monitoring photovoltaic systems have been carried out since the beginning of the past decade. These activities are in general directed to relatively large plants, of tens to hundreds of thousands of kilowatts peak. Developing countries, in contrast, are not well represented in such efforts. In Southern Africa, in particular, the lack of monitoring activities in photovoltaics is almost absolute. This situation does not contribute to an effective deployment of the technology in most regions, as both the natural environmental conditions and the socio-economic context vary from place to place. For populations living in small and dispersed communities, for instance, as is the rule in most parts of Southern Africa, most common energy needs can be better covered by small stand alone plants, ranging from orders of magnitude of tens of watts peak, e. g. home lighting, up to few units of kilowatts peak, e. g. village water supply.

This work reports a research programme undertaken since 1991 whose aims were to design, install and monitor a photovoltaic water pumping plant, with a capacity of 848  $W_p$ , in the region of Maputo, Mozambique. The pumping plant has been installed in 1993 and a monitoring system integrated into it in 1994. The monitoring activities have been carried out during a period of six months, from 1st January to 30th June 1995, and had as a major objective to characterise the performance of the plant under the local environmental conditions. This characterisation comprised a detailed analysis of

the performance of the plant's major components, namely the PV array, the inverter and the motor/pump unit. The costs of the energy services provided by the plant were also determined. Since this work was the first research activity in photovoltaics carried out in Mozambique, one of the major outputs expected with it was that it should facilitate the promotion of photovoltaics in the country. Therefore another objective of this research was that of developing a model for an efficient PV technology transfer in the context of developing countries in general, and to Mozambique in particular.

The results obtained in this research are quite promising. The average global efficiency of  $(3.6 \pm 0.2)\%$  for the pumping plant observed during the period of analysis is an indication that the natural environmental conditions in the region of experimentation are appropriate for an effective deployment of photovoltaic solar energy. The reliability of the plant is very high: no unique fault has been registered during the period 1993-1996. The cost of PV electricity has been determined as varying from 35 up to 72 cents/kWh, if import taxes are not included. Although this is three to four times the cost of electricity provided by the National Power Utility, PV is attractive in most cases where grid extension or diesel generators are required, as grid extension costs about 8,000 - 12,000 US\$/km in Mozambique. Of particular importance is the water pumping application, where the unit cost of water (of about 31 cents per cubic metre, if import taxes are not included) is very competitive to that provided by the National Water Utility (of 26-38 cents per cubic metre) in Mozambique. A general conclusion that can be drawn from this work is that both the environmental conditions and the socio-economic context in this region are appropriate for the deployment of photovoltaics. More monitoring activities, involving other enduses, are required in order to create the necessary basis for an efficient deployment of the technology.

An assessment of this work reveals that an independent and original contribution to knowledge has been made in the framework of the research programme undertaken, especially in (i) undertaking the first application and analysis of the photovoltaic

technology in Mozambique, (ii) undertaking an economic analysis of the technology appropriate to local conditions, (iii) formulating the requirements for innovative technological development in new “centres of expertise in photovoltaics” for the technology transfer and (iv) undertaking a survey of the village requirements on photovoltaic solar energy in Mozambique.

In the beginning God created heaven and earth. Now the earth was a formless void, there was darkness over the deep, with a divine wind sweeping over the waters. God said, "Let there be light" and there was light. God saw that light was good, and God divided light from darkness.

Genesis 1

**This Work is Dedicated to My Parents:**

**Augusto Mabote Cuamba**

**and**

**The Late Lídia Cuinica Chongo Cuamba**

## **Acknowledgements**

The work here presented is a result of a joint research programme undertaken during the period 1991-1995 by the Eduardo Mondlane University (UEM), in Mozambique, the Newcastle Photovoltaics Applications Centre (NPAC), which is a research unit at the University of Northumbria at Newcastle, and IT Power Ltd., both in the UK, under the financial support of the Swedish Organisation SIDA. As part of the Programme, which envisaged the design, installation and monitoring of a photovoltaic pumping plant in Maputo, the author of this work has undertaken MPhil/Ph.D. studies at the University of Northumbria in a sandwich mode.

Professor Robert Hill, the Director of NPAC, has been, during the whole period, the co-ordinator of the Programme on the English side and Director of my MPhil and Ph.D. studies. Professor Hill has made a great contribution to the materialisation of the Programme, from the conception to the elaboration of the final project document submitted to SIDA. During the implementation of the programme he paid visits to Maputo to guide me on all aspects linked with the research. His contribution in the preparation of the present dissertation was of tremendous value. Professor Phil O'Keefe, the Director of ETC Foundation in the UK and member of NPAC, has been working for many years as adviser to the Southern African Development Community in many projects in the areas of energy and environment. He has been involved in the Programme since its inception. He gave me special guidance on the economic and social aspects of energy projects, a field which was completely new for me. He also paid visits to Maputo to help me and gave his considerable contribution in the preparation of this dissertation. The team of supervision included also Dr. Nicola Maria Pearsall, the Manager of NPAC, and Mr. Anthony Derrick, a Director of IT Power Ltd.. Dr. N. M. Pearsall was responsible for guiding me during my stays at NPAC (three months per year), especially on matters concerning literature studies. Mr. Derrick's contribution in the design and installation of the hardware facility was of special importance. He also visited Maputo to support my field studies. To all

members of the supervision team, under the co-ordination of Professor Hill, I would like to express my sincere gratitude for all the guidance and encouragement. I would like also to thank Mrs. Kathleen Hynes, from NPAC, for all the administrative support she gave me during my stays in Newcastle. My thanks are extended to all staff members of NPAC, specially Dr. M. Carter, Dr. R. Miles, Ms. A. Baumann, Dr. I. Forbes, Mr. S. Duke, Ms. T. Blewett, Mr. E. Munyati, Mr. F. Woldehanna and the former colleagues Dr. F. Adurodija, Dr. T. Bhatti and Dr. U. Abel-Thomas. I am also grateful to the staff of the Research Degrees Committee at the University of Northumbria, namely Pat Wigmore, Audrey Fenwick and Mary Quinn, for their assistance. To the staff of IT Power, I express my sincere gratitude. I would like also to thank the staff of ETC Foundation in the UK, specially to Ms. Donna Porter, for support in the production of this thesis.

This work has been possible due to the financial support of SIDA. All the hardware installed in Maputo, my travels and expenses in the UK, the fees at the University of Northumbria, my participation in conferences and some travel costs of the members of the supervision team have been covered by the funding of SIDA. Therefore I express special thanks to this Swedish Organisation. I would like also to thank the British Council for having funded some activities of this work. To the Eduardo Mondlane University, which undertook the responsibility to support the work locally, I am also thankful. Special recognition is addressed to the technicians of the Eduardo Mondlane University, Miguel Fonseca and Santos Luis Victorino, for their contribution in the installation of the hardware, as well as to the whole staff of the Department of Physics at UEM.

To my friends in Mozambique Yolanda Fernandes, Abdul Adamo, Armando Manhengane, Francisco Mabjaia and many others, I am very grateful for the useful and stimulating discussions we had.



I would also like to thank my sister, brothers and relatives, namely Rosa Cuamba, Júlio Cuamba, Lino Cuamba, Mateus Chambal and João Manjate and their families, for their immense support and encouragement during this research work. And last, but not least, I would like to express my special thanks to my wife, Alcina Cuamba, and to my son, Mukuwane Cuamba.

<b>Contents</b>	<b>Pages</b>
<b>Chapter 1: General Introduction</b>	<b>1</b>
1.1 The Context of Work	1
1.1.1 Finite and Renewable Energy Supplies	1
1.1.2 Environmental Issues Associated with Finite Energy Supplies	1
1.1.3 The Role of Renewable Energy Supplies	2
1.1.4 Scope and Aim of Work	4
1.2 Background Theory on Photovoltaic Energy Conversion	6
1.2.1 Solar Cell Operation	6
1.2.2 The Solar Cell Model	12
1.2.2.1 Parametric Analysis of a Solar Cell Current-Voltage Characteristics	17
1.2.2.1.1 Internal Parameters	17
1.2.2.1.2 External Parameters	20
1.2.3 The PV Array	23
1.3 Solar Radiation	24
References	31
<b>Chapter 2: The State-Of-The-Art of Solar Cell Technologies</b>	<b>37</b>
2.1 Introduction	37
2.2 Single- and Polycrystalline Silicon Solar Cells	38
2.3 Thin Film Solar Cells	46
2.3.1 Amorphous Silicon (a-Si) Cells	47
2.3.2 Thin Film Polycrystalline Silicon Cells	53
2.3.3 Copper Indium Diselenide (CIS) Cells	54
2.3.4 Cadmium Telluride Cells	57
2.4 Concentrator Solar Cells	60
2.5 PV Modules	62

2.6 Environmental Risks of Solar Cell Technologies	65
2.7 Conclusions	66
References	68
<b>Chapter 3: Monitoring of a Photovoltaic Water Pumping Plant</b>	<b>78</b>
3.1 Introduction	78
3.2 Theoretical Background	80
3.2.1 Determination of Efficiencies of Major PV Systems Components	80
3.2.2 A Simplified Model for Describing Photovoltaic Array Output	81
3.3 General Considerations on PV Power Plants	87
3.4 The Technology of PV Solar Water Pumping	91
3.4.1 General Considerations	91
3.4.2 The Status of PV Water Pumping in Developing Countries	94
3.4.3 Description of the Hardware	96
3.4.3.1 The Technology of PV Arrays	96
3.4.3.2 The Technology of Motor/Pump Sets	97
3.4.3.3 Power Conditioning	104
3.4.3.4 Water Storage and Distribution	106
3.4.4 Operation and Performance of PV Pumping Systems	107
3.4.5 Available Equipment	110
3.4.6 Equipment Costs	112
3.4.7 Water Sanitation	113
3.5 Monitoring Systems	114
3.6 Experimental Procedure	117
3.6.1 The PV Power Plant Characterisation	117
3.6.1.1 PV Power Plant Description	117
3.6.1.2 Monitoring System Description	123
3.7 Monitoring Results	128
3.7.1 Solar Radiation and Temperature Behaviour	131

3.7.2 Determination of the Conversion Efficiencies of the PV Plant	136
3.7.3 Testing of a Simplified Model for Describing Photovoltaic Array Output	140
3.8 Conclusions	143
<b>Chapter 4: The Economics of the Power Plant</b>	<b>151</b>
4.1 Introduction	151
4.2 Background Theory of Cost Benefit Analysis	152
4.2.1 Data Requirements	152
4.2.1.1 Interest Rate	152
4.2.1.2 Discount Rate	153
4.2.1.3 Inflation Rate	153
4.2.1.4 Energy Escalation Rate	154
4.2.1.5 Service Life of an Installation	154
4.2.1.6 Investment Costs	155
4.2.1.7 Residual Value of a Plant	155
4.2.1.8 Major Operating Costs	155
4.2.1.9 Depreciation	156
4.2.2 Procedure of Cost Benefit Analysis	156
4.2.2.1 Net Present Value	157
4.2.2.2 Internal Rate of Return	158
4.2.2.3 Annuity Method	159
4.2.2.4 Cost Annuity Comparison Method	159
4.2.2.5 Pay-back Period	160
4.2.2.6 Sensitivity Analysis	160
4.3 Life Cycle Cost Analysis of the Plant	160
4.3.1 Major Assumptions	161
4.3.2 Base Case Description	161

4.3.3 Calculation Procedure and Results	163
4.4 Conclusions	168
References	169
<b>Chapter 5: Non-Technical Issues for Promotion of Photovoltaics</b>	<b>171</b>
5.1 Introduction	171
5.2 Energy Technologic Options in Rural Areas: A Case Study in Mozambique	172
5.2.1 The Country's Resources	172
5.2.2 Energy Demands	174
5.2.3 Energy Options	176
5.2.4 The Potential Role of Photovoltaics for Rural Development in Mozambique - Field Study in a Village	178
5.2.4.1 Description of the Sample	179
5.2.4.2 Identification of the Major Niches of Applications of Photovoltaics	180
5.2.4.3 Economic Assessment	184
5.2.4.4 Training Needs	188
5.3 PV Market Analysis	189
5.3.1 Consumer Indoor Segment	192
5.3.2 Consumer Outdoor Segment	192
5.3.3 Remote Industrial Markets	192
5.3.4 Electricity Services to Remote Communities	193
5.3.5 Grid Connected Systems	193
5.3.6 Central Power Plants	194
5.4 A Model for Building Endogenous Capability in Photovoltaics	195
5.4.1 The Concept of Technology Transfer	195
5.4.2 Technology transfer in Developing Countries	196
5.4.3 Building of Centres of Expertise as an Effective Model for Creating Endogenous Capabilities in Photovoltaics	197

<b>5.4.4 The Ranges of Expertise of the Centres</b>	<b>198</b>
<b>5.5 A Model for a Successful Dissemination of Photovoltaics in Mozambique</b>	<b>200</b>
<b>5.5.1 Dissemination Mechanisms</b>	<b>200</b>
<b>5.5.2 Technical Support</b>	<b>203</b>
<b>5.5.3 Financial Arrangements</b>	<b>204</b>
<b>5.6 Conclusions</b>	<b>205</b>
<b>References</b>	<b>208</b>
<b>Appendix A: List of Abbreviations</b>	<b>211</b>
<b>Appendix B: Glossary</b>	<b>212</b>
<b>Appendix C: Major Suppliers of PV water pumping equipment</b>	<b>219</b>
<b>Appendix D: The methodology of designing a PV water pumping system</b>	<b>222</b>
<b>Appendix E: Description of the main plant's components</b>	<b>230</b>
<b>Appendix F: Costs of equipment and services</b>	<b>233</b>
<b>Appendix G: The map of Mozambique</b>	<b>234</b>
<b>Appendix H: Extension work undertaken</b>	<b>235</b>
<b>Appendix I: Chronology of Activities</b>	<b>236</b>

<b>List of Figures</b>	<b>Pages</b>
<b>Figure 1.1:</b> Schematic representation of the Photovoltaic Effect, from source [37]	6
<b>Figure 1.2:</b> A photovoltaic junction in the dark	7
<b>Figure 1.3:</b> Representation of a solar cell	8
<b>Figure 1.4:</b> Maximum solar cell efficiency versus energy gap of semiconductor absorbing sunlight, from source [37]	9
<b>Figure 1.5:</b> Loss mechanisms in a silicon homojunction solar cell, from source [37]	11
<b>Figure 1.6:</b> Equivalent circuit of a voltage source (a) and current source (b)	12
<b>Figure 1.7:</b> Equivalent circuit of a solar cell	13
<b>Figure 1.8:</b> I-V characteristic curves of a solar cell, from source [45]	15
<b>Figure 1.9:</b> Solar cell (a) in the short-circuit condition and (b) in the open circuit condition, from source [45]	16
<b>Figure 1.10:</b> Effect of series resistance on the I-V curve shape, from source [45]	19
<b>Figure 1.11:</b> Effect of shunt resistance on the I-V curve shape, from source [45]	19
<b>Figure 1.12:</b> Influence of solar irradiance on a solar cell current and voltage output characteristics at a constant cell temperature, from source [45]	20
<b>Figure 1.13:</b> Typical influence of temperature on solar cell efficiency, from source [45]	22
<b>Figure 1.14:</b> Examples of cells connected in series and parallel	23
<b>Figure 1.15:</b> The structure of the sun, from source [46]	25

<b>Figure 1.16:</b> Spectral distribution of the extraterrestrial radiation $G_{\text{e}\lambda}^*$ (NASA standard curve, NASA, 1971), from source [1]	26
<b>Figure 1.17:</b> Spectral distribution of the sun's radiation compared with blackbody distributions corresponding to different temperatures, from source [38]	26
<b>Figure 1.18:</b> Illustration of the solar radiation spectrum labelled AMO in space, AM1 at the earth's surface for normal incidence, and $AM_n$ at the earth's surface with $m=\sec z$ , where $z$ is the deviation from normal incidence, from source [38]	29
<b>Figure 1.19:</b> Comparison of AMO and AM2 spectra, showing the various atmospheric absorption bands in AM2, from source [38]	29
<b>Figure 2.1:</b> Solar-cell-manufacturing process, from source [23]	39
<b>Figure 2.2:</b> The Czochralski crystal growth process for preparing crystalline silicon ingot is shown. A seed crystal is dipped into molten silicon and slowly removed, drawing out the cylindrical crystal. From source [24]	41
<b>Figure 2.3:</b> Silicon wafers can be cut from grown ingots with an inner diameter saw, from source [24]	42
<b>Figure 2.4:</b> (a) Polycrystalline silicon ingots are formed by controlled solidification in a crucible, or mold. The ingots are then cut into smaller sections. (b) Ingots before being cut into wafers. From source [24].	42
<b>Figure 2.5:</b> Buried contact solar cell from BP Solar, from source [28]	44
<b>Figure 2.6:</b> The device structure of a-Si cell, from source [36]	49
<b>Figure 2.7:</b> Schematic diagram of an a-Si multijunction cell, from source [36]	50
<b>Figure 2.8:</b> Basic structure of a $\text{Cu}(\text{In,Ga})(\text{Se,S})_2$ cell, from source [29]	55
<b>Figure 2.9:</b> The structure of the CdTe-CdS solar cell, from source [29]	58



<b>Figure 2.10:</b> Photograph and drawing of the Sandia design point focus concentrator module, from source [36]	61
<b>Figure 2.11:</b> Integrally interconnected module, from source [28]	64
<b>Figure 3.1:</b> Simplified power flow diagram of the PV array field, showing typical string wiring. From source [9]	84
<b>Figure 3.2:</b> Three basic types of PV system configuration: a) stand alone, b) hybrid and c) grid-connected. From source [12]	88
<b>Figure 3.3:</b> Various motor/pumpset configurations, from source [16]	103
<b>Figure 3.4:</b> Configuration of pumps for various heads and volumes, from source [16]	109
<b>Figure 3.5:</b> The schematic diagram of the experimental set-up of the Eduardo Mondlane University	119
<b>Figure 3.6:</b> A photo of the experimental set-up of the Eduardo Mondlane University	120
<b>Figure 3.7:</b> Components of the power plant (the Grundfos inverter SA 1500)	121
<b>Figure 3.8:</b> Components of the power plant (the submersible Grundfos motor/pump unit)	122
<b>Figure 3.9:</b> Schematic of the power plant with associated monitoring system	125
<b>Figure 3.10:</b> Components of the monitoring system (the datalogger 21 X)	126
<b>Figure 3.11:</b> Components of the monitoring system (A radiation sensor)	127
<b>Figure 3.12:</b> Behaviour of solar radiation in the horizontal and in the plane of the array surface in 6th January 1995	132
<b>Figure 3.13:</b> Average monthly values of radiation from January to June 1995	133
<b>Figure 3.14:</b> Behaviour of ambient temperature and of PV modules temperature in 6th January 1995	134

<b>Figure 3.15: Average monthly values of temperature from January to June 1995</b>	135
<b>Figure 3.16: Conversion efficiencies of the array in 5th June 1995</b>	137
<b>Figure 3.17: Monthly averages of conversion efficiencies of the plant</b>	138
<b>Figure 3.18: Array output energy in 6th January 1995</b>	141
<b>Figure 3.19: Array output energy during January 1995</b>	142
<b>Figure 4.1: Unit cost of DC electricity produced by the PV array</b>	165
<b>Figure 4.2: Unit cost of AC electricity produced by the PV array</b>	166
<b>Figure 4.3: Unit cost of water pumped by the PV plant</b>	167
<b>Figure 5.1: History of module costs, from source [14]</b>	191

<b>List of Tables</b>	<b>Pages</b>
<b>Table 2.1:</b> Efficiencies of crystal silicon cells, from source [28]	45
<b>Table 2.2:</b> a-Si module efficiencies, from source [29]	52
<b>Table 2.3:</b> projected costs of a-Si modules, from source [29]	52
<b>Table 2.4:</b> Summary of the highest efficiencies of Cu(In,Ga)(Se,S) <sub>2</sub> cells reported in the recent years, from source [29]	55
<b>Table 2.5:</b> Projected costs of Cu(In,Ga)(Se,S) <sub>2</sub> modules, from source [29]	56
<b>Table 2.6:</b> Module efficiencies of CdTe cells, from source [29]	59
<b>Table 2.7:</b> Estimation of prospective costs for CdTe module production, from source [29]	59
<b>Table 3.1:</b> Recommended values for use in array power capability calculations. From source [9]	86
<b>Table 3.2:</b> Configuration of pumps available and power ranges in $W_p$ , from source [16]	111
<b>Table 3.3:</b> Main characteristics of the sensors and signal conditioning devices used, from sources [31-36]	124
<b>Table 3.4:</b> Data measured in 5th May 1995	129
<b>Table 3.5:</b> Data collected directly from AC energy and water flow meters in May 1995	130
<b>Table 3.6:</b> Monthly averages of the plant's components efficiencies	136
<b>Table 4.1:</b> Monthly mean values of DC/AC energy and of water flow	163
<b>Table 4.2:</b> Total unit costs of energy services provided by the PV system, when import taxes are excluded	164
<b>Table 4.3:</b> Total unit costs of energy services provided by the PV system, when import taxes are included	164

# **Chapter 1**

## **General Introduction**

## **1.1. The Context of Work**

### **1.1.1 Finite and Renewable Energy Supplies**

For all practical purposes energy supplies can be divided into two main classes [1-5]:

. Finite energy, which is energy obtained from static stores of energy that remain bound unless released by human interaction; examples of this class of energy are fossil fuels or coal, oil, natural gas and nuclear fuels;

. Renewable energy, which is energy obtained from the continuous or repetitive currents of energy occurring in the natural environment; obvious examples of this type of energy are solar and wind energies.

The ultimate sources of useful energy can be classified into five main categories: (i) the sun, (ii) the motion and the gravitational potential of the sun, moon and earth, (iii) geothermal energy from cooling, chemical reactions, and radioactive decay in the earth; (iv) nuclear reactions on the earth and (v) chemical reactions from mineral resources. Finite energy is derived from the sources of categories (i) (fossil fuels), (iii) (hot rocks), (iv) (nuclear energy) and (v) (batteries), whilst renewable energy is derived from sources of the categories (i) (wind and solar energy), (ii) (tidal energy) and (iii) (geothermal energy). Fossil fuels energy sources, especially coal, oil and natural gas, were the major driving force for the industrial revolution in Europe and North America, and, together with the nuclear fuels, they contributed a lot to the global industrial development in all countries. Almost all types of conventional energy supplies are derived from finite energy supplies.

### **1.1.2 Environmental Issues Associated with Finite Energy Supplies**

The past decade was characterised by a growing awareness on the environmental effects of the conventional energy supplies in developed countries. According to the actual understanding of the issue [6-11], fossil fuel energy technologies produce

dangerous greenhouse gases, like oxides of carbon, sulphur and hydrocarbons, which pollute the atmosphere. The most significant of all is carbon dioxide (CO<sub>2</sub>), which influences the climate via the so called greenhouse effect, the cause of global warming. Another by-product of fossil fuels energy usage is aerosols (i.e., suspensions of solid or liquid particles in the atmosphere); aerosols influence climate because they alter the energy exchanges between the sun and the atmosphere and between the atmosphere and the ground. Nuclear fuels also have upper limits to environmental hazards because of the danger of radioactive materials they release. These materials can influence the life on the earth.

### **1.1.3 The Role of Renewable Energy Supplies**

Renewable energy supply systems can be divided into three broad divisions [1-5, 12-16]: (i) mechanical supplies, including hydro, wind, wave and tidal power; (ii) heat supplies, incorporating biomass combustion and solar collectors and finally (iii) photon processes, which encompass photovoltaic conversion and photosynthesis. Renewable energy is always extracted from a flow of energy already occurring in the environment. The energy is then returned to the environment, so pollution can occur only on a small scale. Likewise material and chemical aspects of pollution in air, water and refuse tend to be minimal. The most serious objections often relate to the ecological impact of large scale or concentrated renewable energy deployments like large hydro-power installations, which occur where water is naturally concentrated by mountain or hill formations. Apart from the environmental aspects, there is an additional advantage of renewable energy supplies against the finite ones, which relates to the fact that in a long term perspective the later will be depleted while the former will remain for ever.

A pronounced difference between renewable and finite energy supplies is the energy flux density at the initial transformation. Renewable energy commonly arrives at about 1 kWm<sup>-2</sup> (e. g., solar beam irradiance, energy in the wind at 10m/s), whereas finite

centralised sources have energy flux densities that are orders of magnitude greater. For instance, boiler tubes in gas furnaces easily transfer  $100 \text{ kWm}^{-2}$  and in a nuclear reactor the first wall heat exchanger must transmit several  $\text{MWm}^{-2}$ . Thus, from the technical point of view it can be stated that finite energy supply is most easily harnessed centrally and is expensive to distribute, whilst renewable energy supply is most easily harnessed in dispersed locations and is expensive to concentrate.

Developing countries are characterised by having most of their populations living in rural areas grouped in small communities spread over the countries [17-20]. In Southern Africa, particularly, the densities of such communities are mostly far below 100 people per square kilometre and more than 80% of the total population is living in rural areas. Basic enduses for which energy is required in a rural context include, among others, (i) water pumping, (ii) cooking (iii) health care, (iv) education, (v) home power, (vi) telecommunications, (vii) rural electrification and (viii) traffic, air and marine signalling. Renewable energy supply systems represent the most appropriate way to meet small scale energy needs, as is the case in most rural areas in Southern Africa.

Photovoltaics (PV), the technology which converts solar radiation directly into electricity, is one of the renewable energy technologies that has a significant role to play in supplying energy, especially in the rural context of most developing countries, which generally are located in the "sunbelt" from  $40^{\circ}\text{N}$  to  $40^{\circ}\text{S}$  [21-26]. PV is the best and least expensive power option today in the small power range from units of watts up to few kilowatts. It can easily be decentralised and sized according to the demand of the individual or community. It can be mounted on rooftops and cladds, thereby saving costs on roofing and cladding materials. Modularity and low need for maintenance are extra advantages of this technology.

#### **1.1.4 Scope and Aim of Work**

The photovoltaic effect was discovered in 1839 by the French physicist Becquerel, when he observed that a photovoltage was developed when light was directed onto one of the electrodes in an electrolyte solution [27-29]]. Adams and Day were the first to observe the photovoltaic effect in a solid (selenium) in 1877. Early solid state researchers including Lange, Grondahl and Schottky did pioneering work on selenium and cuprous oxide PV cells. By 1914 solar conversion efficiencies of about 1% were achieved with the selenium cell. However, it was not until 1954 that scientific literature published results on the use of the PV effect in energy conversion processes. In that year Chapin et al [26] reported a solar conversion efficiency of 6% for a silicon single-crystal cell. With improved technology, silicon cell efficiency under terrestrial sunlight had reached 10% by 1958. The interest in using PV cells for terrestrial applications started with the oil crisis of 1973. Since then, there has been an intensive research work world-wide aiming at reducing the energy services provided by photovoltaics to the level that it is competitive with conventional energy supply systems. Present efficiencies of silicon single-crystal solar cells in the laboratory reach the 23% [30-33].

Nowadays the technology of solar cells is mature, although room for more innovative work is still available. One of the key issues that deserves special attention of today's research is that of optimising the performance of systems based on solar cell devices. Photovoltaic conversion of solar energy and its use is, like any renewable energy supply, intimately linked to the natural environment. Therefore, a good understanding of the effect of environmental parameters in situ upon the performance of the technology is essential for its efficient use. In order to achieve such an understanding, it is required to undertake monitoring activities of photovoltaic power plants in regions where they have potential applicability. In Europe, in the United States and in Japan extensive programmes of monitoring PV systems have been carried out since the beginning of the last decade [34-36]. The activities are generally directed to large plants, of the orders of magnitude of tens of kilowatts peak and tending to hundreds of



kilowatts peak. All these countries emphasise grid connection. The 300 kW<sub>p</sub> Pellworm plant in Germany and the 100 kW<sub>p</sub> Kythnos plant in Greece are illustrative examples. Developing countries, in contrast, undertake very few monitoring activities. In Southern Africa, in particular, the lack of such activities is almost absolute. This means that the experience in using PV accumulated so far is mainly based on European, Japanese and North American pilot projects. This situation does not contribute to an effective promotion of the technology in most regions, since the natural environment and the socio-economic conditions are different in sunny developing countries when compared to those encountered in Europe, Japan or North America. For populations living in small and dispersed groups, for instance, as found in most developing Southern African countries, most common energy needs could be covered by power plants ranging from orders of magnitudes of tens of watts peak, e.g. home lighting, up to few units of kilowatts peak, e.g. village water supply. In contrast, tens or hundreds of kilowatts peak are required in the context of developed countries. This means that there is a dire need to undertake PV monitoring activities in the Southern African Region, considering the types of applications and the extent to which the systems respond to local developmental issues.

A research programme aiming at studying the performance of a PV power plant operating in a Southern African environment was undertaken in Mozambique, a country located between the latitudes 10° and 26° S and between the longitudes 30° and 41° E. The programme addressed three main objectives: (i) the technical characterisation of the plant, (ii) its economic evaluation and (iii) the development of a technology transfer model which would contribute to a successful local promotion of this technology. For this purpose a PV water pumping plant (with a capacity of about 1 kW<sub>p</sub> equipped with an appropriate system for analytical monitoring) was designed and installed at the Campus of the Eduardo Mondlane University, located at the capital city Maputo. Monitoring activities were carried out during a period of six months.

This thesis presents, in chapter 1, the general introduction of the basic theories of solar cells and solar radiation. A review of the state-of-the-art of solar cell materials and devices is presented in chapter 2. Chapter 3 consists of details of the experimental set up of the investigations carried out. Also included in this chapter are experimental results and discussions regarding the technical characterisation of the plant, whilst chapter 4 discusses its socio-economic factors. The thesis ends with the presentation of non-technical aspects for promotion of photovoltaics, in chapter 5.

## 1.2. Background Theory on Photovoltaic Energy Conversion

### 1.2.1 Solar Cell Operation

Solar cells are devices which absorb light and convert it into electrical energy [1, 37-45]. The absorption of light in semiconductors creates electrical charge carriers, both electrons and holes equally. If an electric field exists, i.e. a “voltage”, within the semiconductor, the negative electrons and positive holes move in opposite directions, and this electrical charge separation results in the creation of a voltage. This is the photovoltaic effect: - the creation of a charge separation by the action of light (see Figure 1.1).

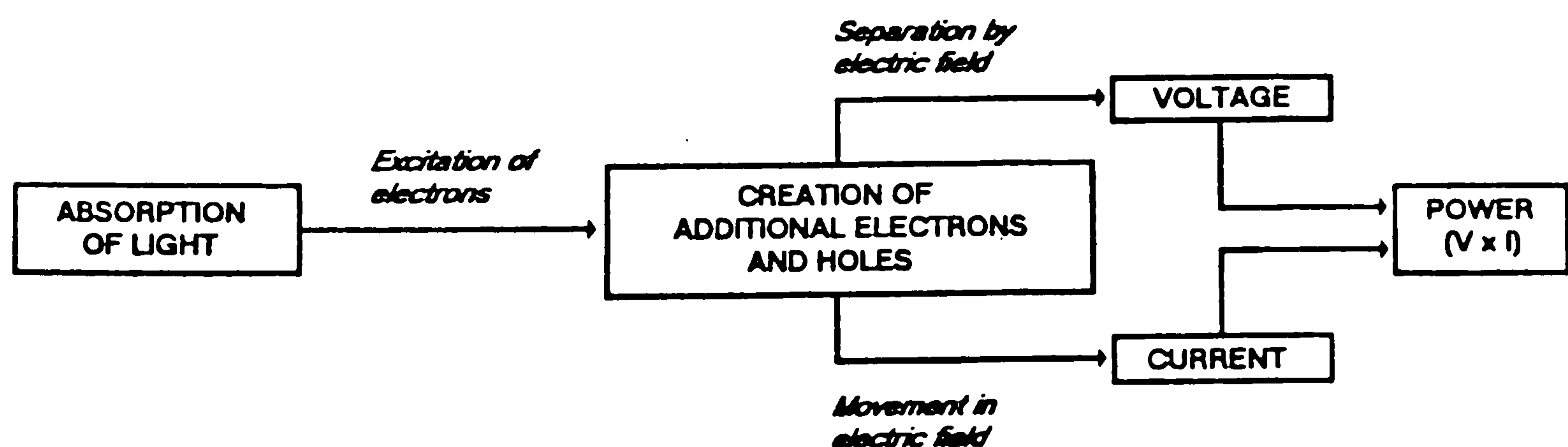

Figure 1.1: Schematic representation of the Photovoltaic Effect, from source [37].

The simplest way to establish an electric field in a semiconductor is to make a p-n junction. This can be achieved by taking a p type material and diffusing donor impurities onto specified regions so that these become n type in the otherwise continuous material, and vice versa [1]. The region of such a dopant change is a p-n junction. Considering that the junction has been formed intrinsically, then excess donor electrons from the n type material cross to the acceptor p type, and vice versa for holes [1]. A steady state is eventually reached, with the establishment of an electric field caused by the accumulation of charges of opposite sign on each side of the junction (see Figure 1.2). There is now an excess negative charge on the p side and positive on the n side. Electrons and holes may be generated thermally or by light, and so become carriers in the material. In particular, the absorption of solar radiation can greatly increase electron-hole generation in addition to thermal generation. Creating this charge carrier near the p-n junction, using sunlight, then the built-in field can be the electromotive force to maintain charge separation and produce currents in an externally connected circuit. The electric current is fed via the metal contacts on the p and n layers to an external load (see Figure 1.2). Thus the photon generation of carriers in sunlight adds to, and dominates, the thermal generation already present. In dark conditions, of course, only the thermal generation occurs.

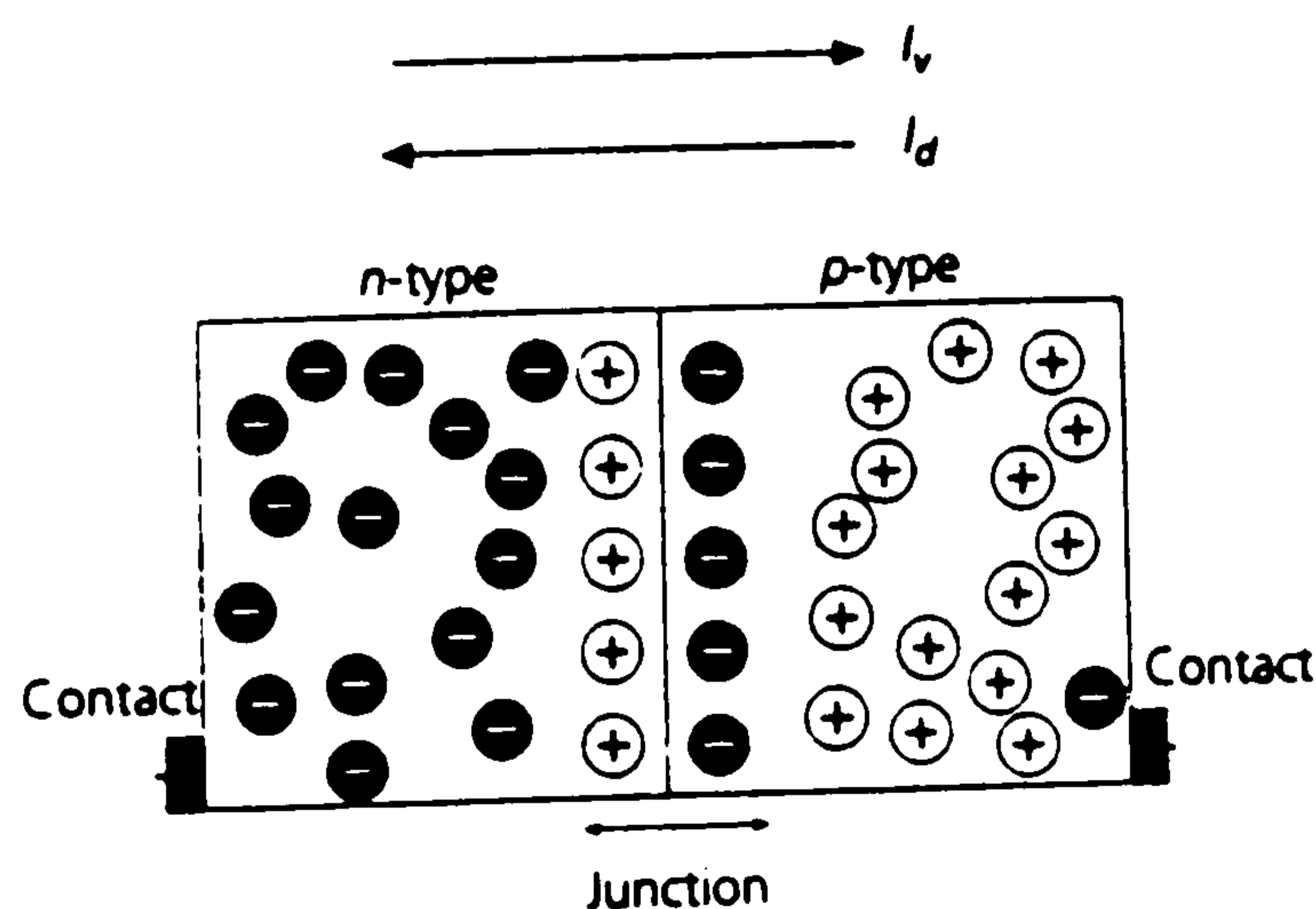

Figure 1.2: A photovoltaic junction in the dark.

The requirements for a solar cell are thus:

- . A semiconductor diode of large junction area, to collect as much light as possible.
- . Electrical contacts on each side of the cell. One side must collect incident light, so the contact must be as transparent as possible. It can be a transparent conductor or fine metal fingers spaced widely apart, as shown in Figure 1.3.

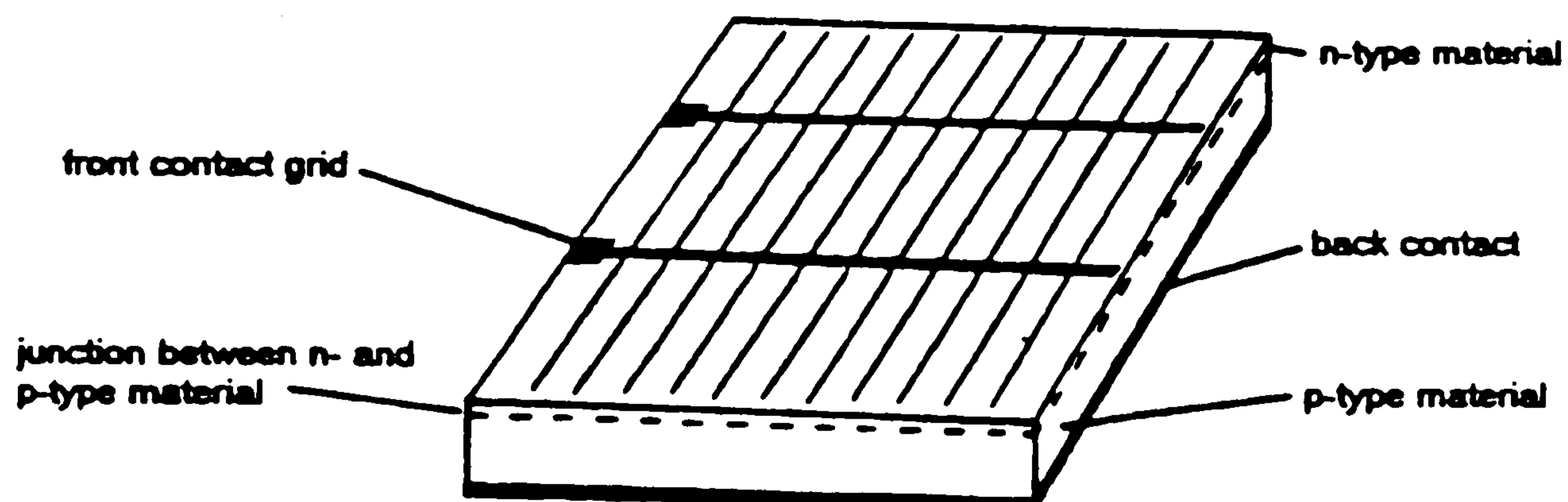

Figure 1.3: Representation of a solar cell.

There are many hundreds of semiconductors materials, but only a very few have been found to be suitable for use as solar cells. The first criterion for choosing a solar cell material is its energy gap, which is the energy required to free an electron from a fixed

site. The voltage which a cell has across its faces on open circuit is a fraction (known as the Voltage Factor) of its energy gap, so the larger the energy gap the higher the voltage. For a light source such as the sun with its energy spread over a wide range of photon energy (colours) the higher the energy gap the smaller the fraction of sunlight which can be absorbed, and therefore the lower the current. There is thus an optimum energy gap for a solar cell at which the product of voltage and current is a maximum. The variation of maximum cell efficiency with semiconductor energy gap is shown in Figure 1.4. There are a number of well-known semiconductors materials close to the optimum energy gap, including silicon (Si), gallium arsenide (GaAs), copper sulphide ( $\text{Cu}_2\text{S}$ ) and cadmium telluride (CdTe). Other materials close to the optimum include copper indium diselenide (CIS) and amorphous silicon (a-Si:H) and alloys of these materials.

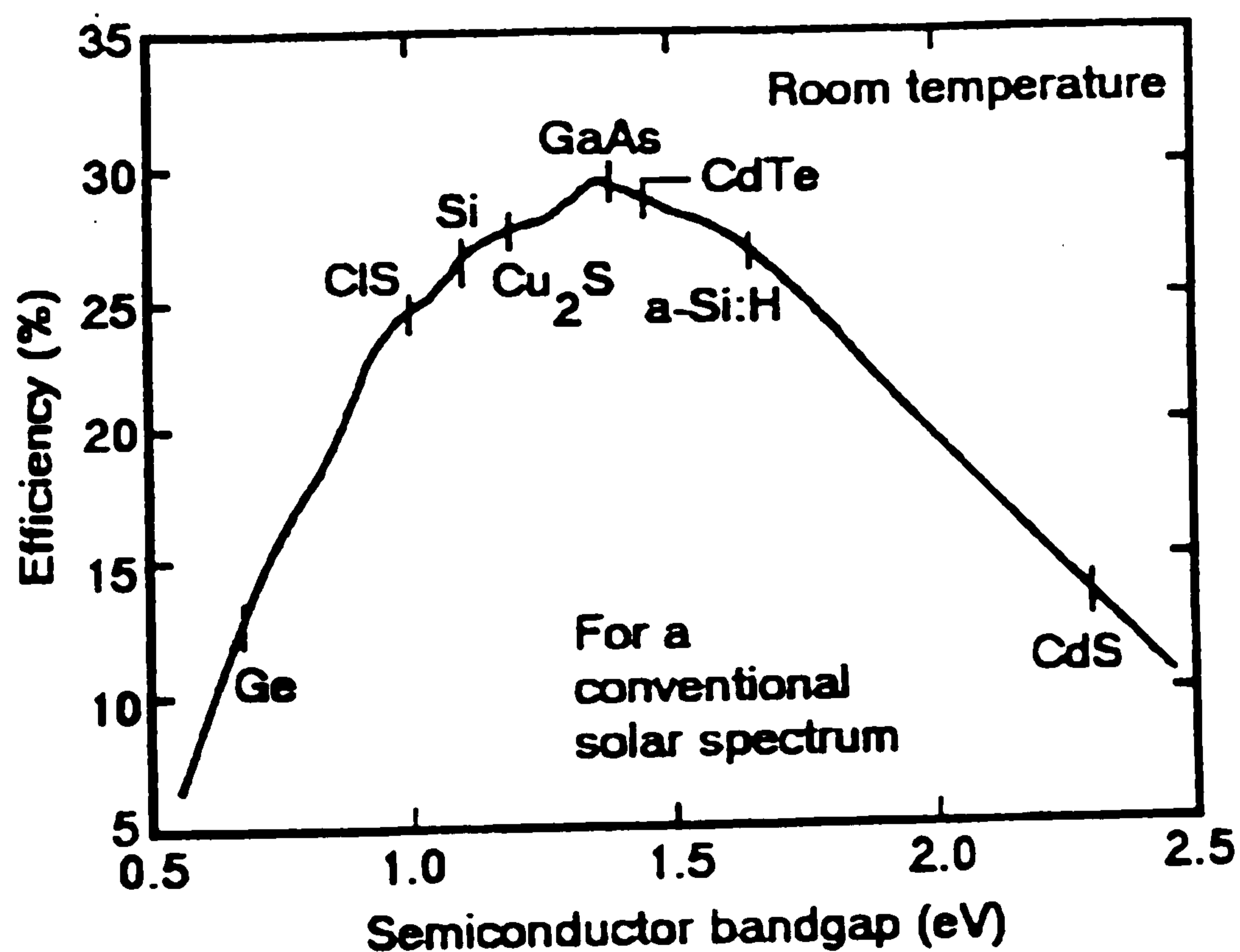

Figure 1.4: Maximum solar cell efficiency versus energy gap of semiconductor absorbing sunlight, from source [37].

The efficiency of a solar cell is determined by three physical factors and three main engineering factors. Sunlight whose energy is less than the energy gap is not absorbed and so not converted into electricity. Sunlight whose energy is higher than the energy gap can donate only an energy equal to the energy gap and the rest is dissipated. Finally the voltage output is about  $2/3$  of the energy gap, with a dissipation of the excess energy or absorption. These three factors determine the maximum possible efficiency. The three engineering factors such as reflectance, series resistance and recombination reduce the efficiency of the actual cells below the maximum value. These effects are shown for silicon in Figure 1.5.

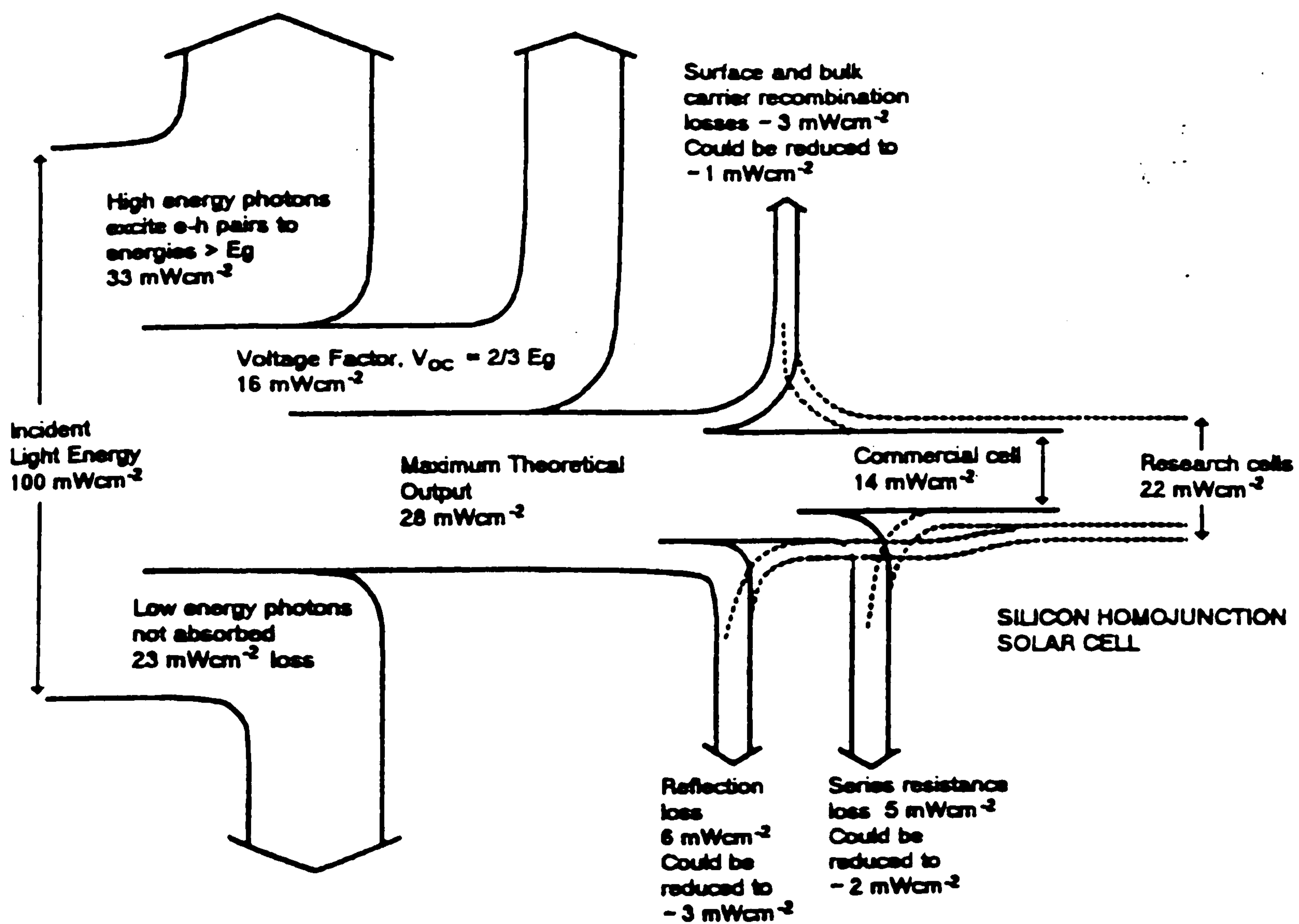

Figure 1.5: Loss mechanisms in a silicon homojunction solar cell, from source [37].

Since sunlight has at most a power density of  $1000 \text{ Watts/m}^2$  at ground level, solar cells must cover a large area to collect substantial amounts of power. This large area must be produced and deployed at as low a cost as possible and cells should ideally be made by a low-cost mass-production process. The ideal material should be cheap, abundant and environmentally benign and suffer no degradation over 30 years of operation. Such an ideal material has not yet been found, but the materials in commercial use, or in commercial development, are well able to provide the basis of an expanding and effective industry for the next 20-30 years [37].

### 1.2.2 The Solar Cell Model

Energy converters to produce electricity can be generally classified into voltage sources and current sources (see Figure 1.6).

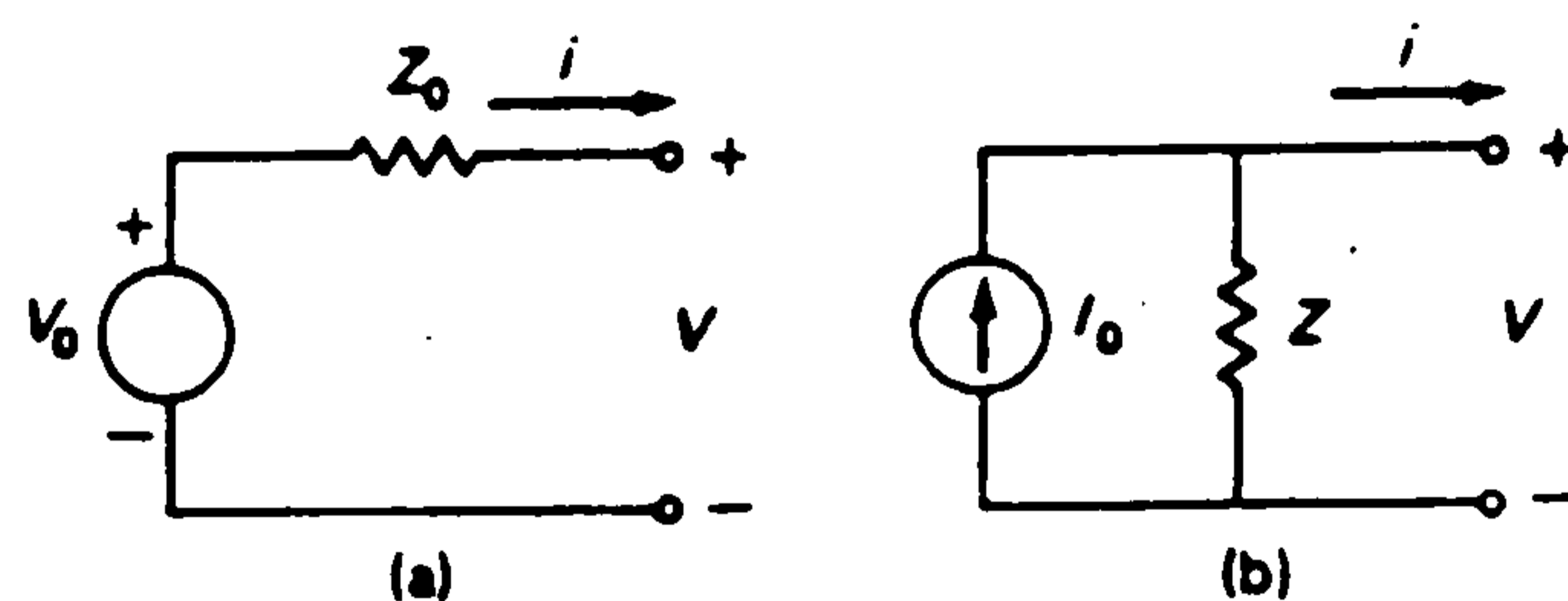

Figure 1.6: Equivalent circuit of a voltage source (a) and current source (b).



An ideal solar cell is a current source, but a real cell encompasses both features of voltage and current sources. Its equivalent circuit is represented in Figure 1.7. According to it, the useful current  $I$  generated by a solar cell can be represented as:

$$I = I_L - I_D - I_{SH} \quad (1.1)$$

where  $I_L$  (A) is the photocurrent,  $I_D$  (A) the diode current and  $I_{SH}$  (A) the leakage current at the shunt resistance  $R_{SH}$  (p-n junction).

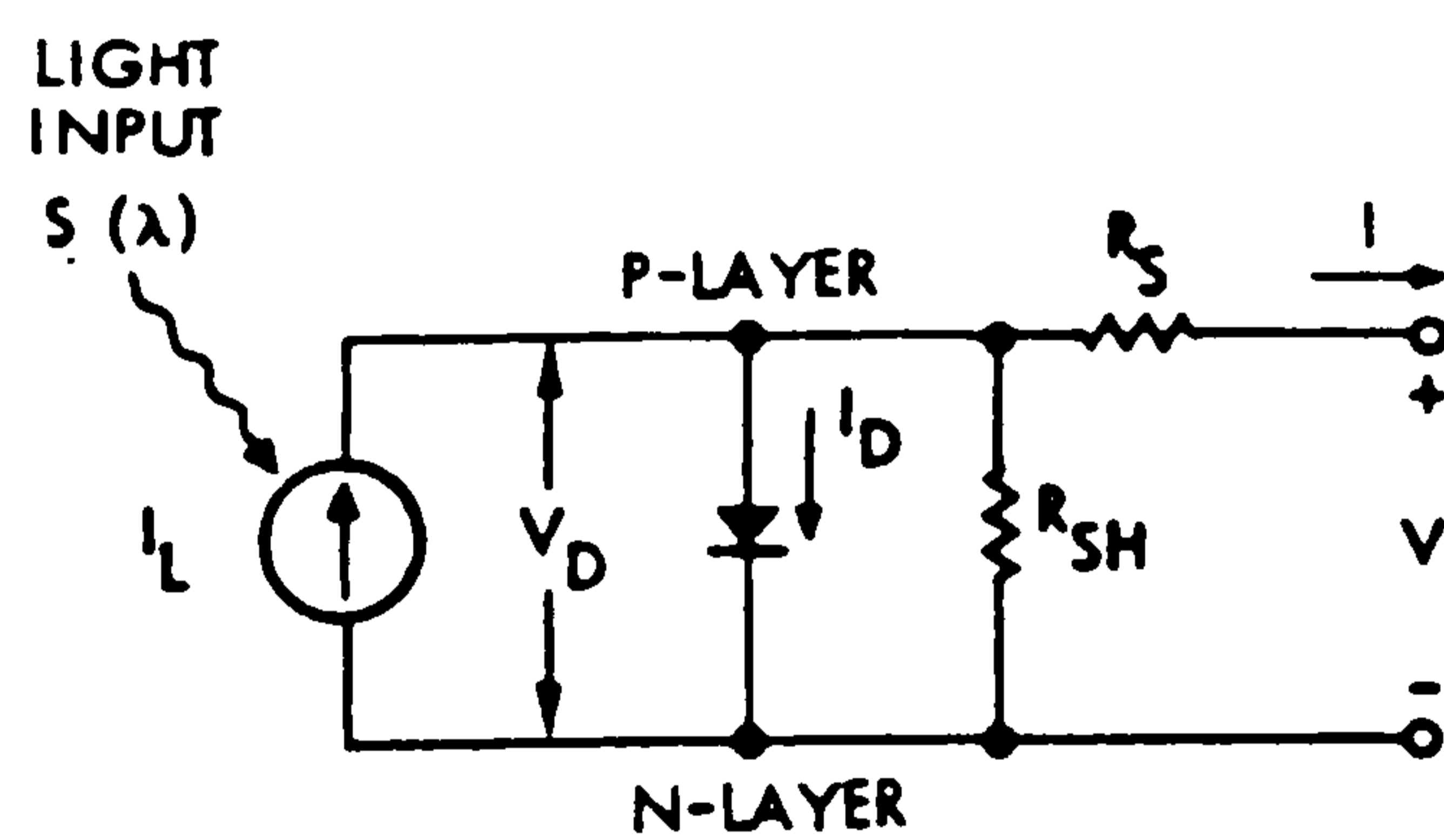

Figure 1.7: Equivalent circuit of a solar cell.

The operating equation of a solar cell, whose equivalent circuit is shown above, derived from solid state physics theory and regarding observations of the solar cell terminal characteristics under a variety of test conditions, can be represented as follows [1, 38-45]:

$$I = I_L - I_0 \left\{ \exp \left[ \frac{e(V + IR_s)}{Ak_B T} \right] - 1 \right\} - \frac{V + IR_s}{R_{SH}} \quad (1.2)$$

The symbols are defined as follows:

A - An arbitrary curve-fitting constant between 1 and 5;

$R_S$  - Cell's series resistance;

$R_{SH}$  - Cell's shunt resistance;

I - Cell's output current;

$I_L$  - Light generated current;

$I_0$  - Diode saturation current;

e - Electronic charge;

V - Cell's terminal voltage;

$k_B$  - Boltzmann's constant;

T - Absolute temperature.

$I_0$  is also called the leakage or diffusion current. Its value is of about  $10^{-8} \text{ Am}^{-2}$  for good cells and  $10^{-7} \text{ Am}^{-2}$  for Si material [1].

The solar cell electrical terminal characteristics under the influence of meteorological conditions available in situ (irradiance level and ambient temperature) can be described by its current-voltage (I-V) characteristic curves, as shown in Figure 1.8.

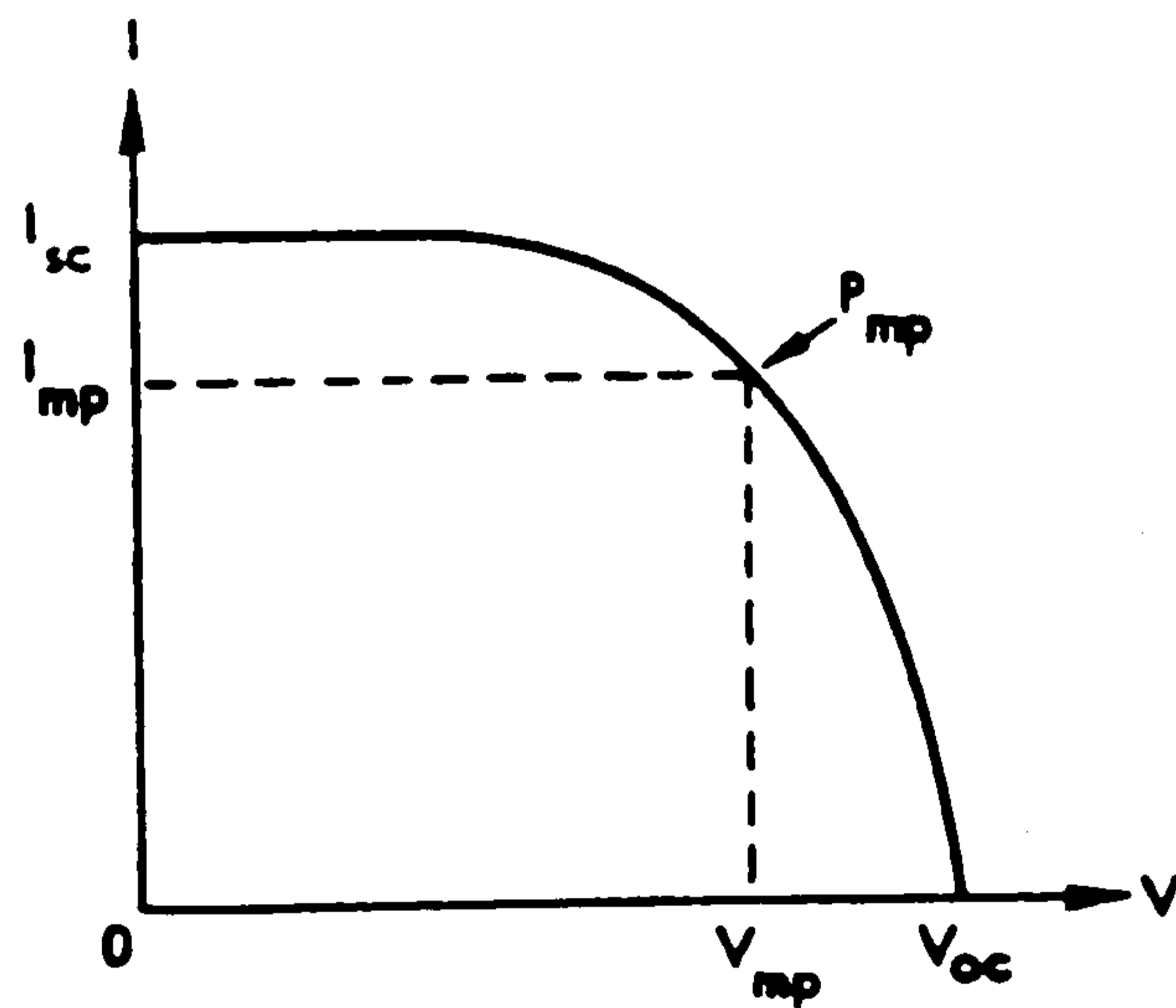

Figure 1.8: I-V characteristic curves of a solar cell, from source [45].

The solar cell graph,  $I=f(V)$ , represented above, passes through three significant points: the short circuit current  $I_{sc}$ , the open circuit voltage  $V_{oc}$  and the maximum power point  $P_{mp}$ . The short circuit current,  $I_{sc}$ , is the current measured in a solar cell terminal when the cell terminal voltage is zero, or  $V=0$ , (see Figure 1.9). For this condition it can be written that

$$I_{sc} = I_L = KE_e, \quad (1.3)$$

where  $K$  is a constant and  $E_e$  ( $Wm^{-2}$ ) is the irradiance.

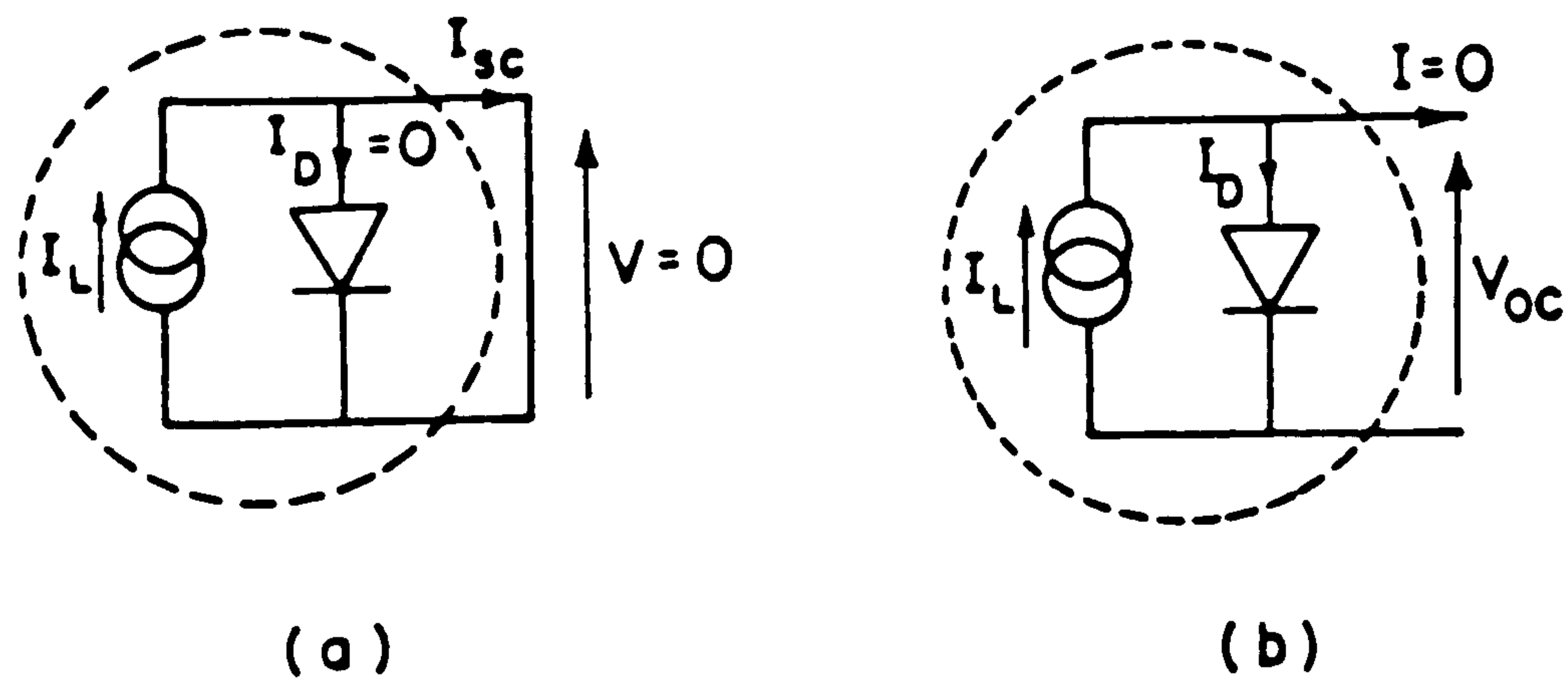

Figure 1.9: Solar cell (a) in the short-circuit condition and (b) in the open circuit condition, from source [45].

The open circuit voltage  $V_{oc}$  corresponds to the voltage drop across the p-n junction when it is traversed by the light generated current  $I_L$ , this means that  $I=0$  (see Figure 1.9). In the open circuit condition, the open circuit voltage can be expressed as:

$$V_{oc} = \frac{Ak_B T}{e} \ln\left(\frac{I_L + I_o}{I_o}\right) = \frac{Ak_B T}{e} \ln\left(\frac{KE_e}{I_o}\right), \quad (1.4)$$

The maximum power point,  $P_{mp}$ , occurs at the inflexion of the curve I-V. At this point there is an optimum power current,  $I_{mp}$ , and a maximum power voltage,  $V_{mp}$ .

The following definitions are of basic importance in solar cell terminology:

Peak power is the optimal power delivered by the cell for an irradiance of  $1 \text{ kWm}^{-2}$  and for a junction temperature of  $25^\circ\text{C}$ .

Conversion efficiency is the ratio of the optimal electric power  $P_{opt}$  delivered by the cell from the solar irradiance  $E_e$  received at a given cell temperature, i. e.:

$$\eta = \frac{P_{opt}}{AE_e}, \quad (1.5)$$

where the optimal electric power  $P_{opt}$  is in watts, the irradiance  $E_e$  in watts per square metre and the cell area  $A$  in square metres.

Fill factor,  $FF$ , is the ratio of the peak power to the product  $I_{sc}V_{oc}$ :

$$FF = \frac{V_{mp}I_{mp}}{I_{sc}V_{oc}}. \quad (1.6)$$

The shape of the solar cell characteristics,  $I=f(V)$ , determines the fill factor, and its value is about 0.7 for good cells and is always smaller than 1.0.

### 1.2.2.1 Parametric Analysis of a Solar Cell Current-Voltage Characteristics

Five parameters govern the electrical behaviour of a solar cell. They are as follows:

#### . Internal Parameters

- . Series resistance  $R_S$ ;
- . Shunt resistance  $R_{SH}$ ;
- . Saturation current  $I_0$ ;

#### . External Parameters

- . Irradiance  $E_e$ ;
- . Temperature  $T$ .

#### 1.2.2.1.1 Internal Parameters

Under normal levels of irradiance (no concentration) these parameters can be considered as independent except for two, the saturation current  $I_0$  and the cell temperature  $T$ . The series resistance depends mainly on the resistivity of the grid contact and the surface layer. The shunt resistance is due to the leakage current at the

junction and depends on the method of junction construction (recombination of carriers within the bulk of the material). Graphically, the series resistance will modify slightly the shape of the I-V characteristic curves in the region where the cell behaves as a voltage generator (see Figure 1.10). The shunt resistance causes an increase in the slope in the cell's characteristic in the region where the cell behaves as a current generator (see Figure 1.11). The diffusion current  $I_0$  contributes to reduce the light generated current  $I_L$ .

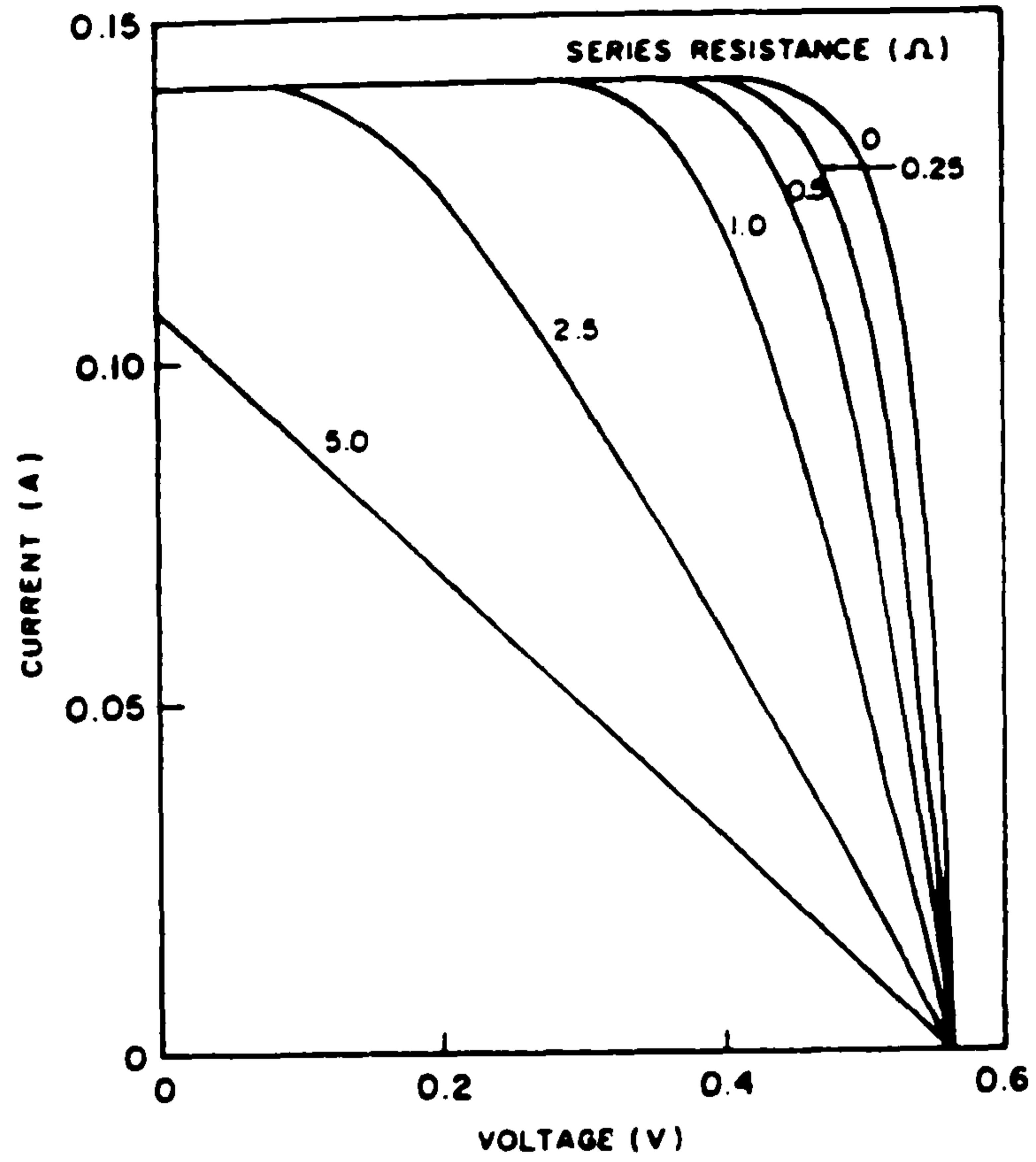

Figure 1.10: Effect of series resistance on the I-V curve shape, from source [45].

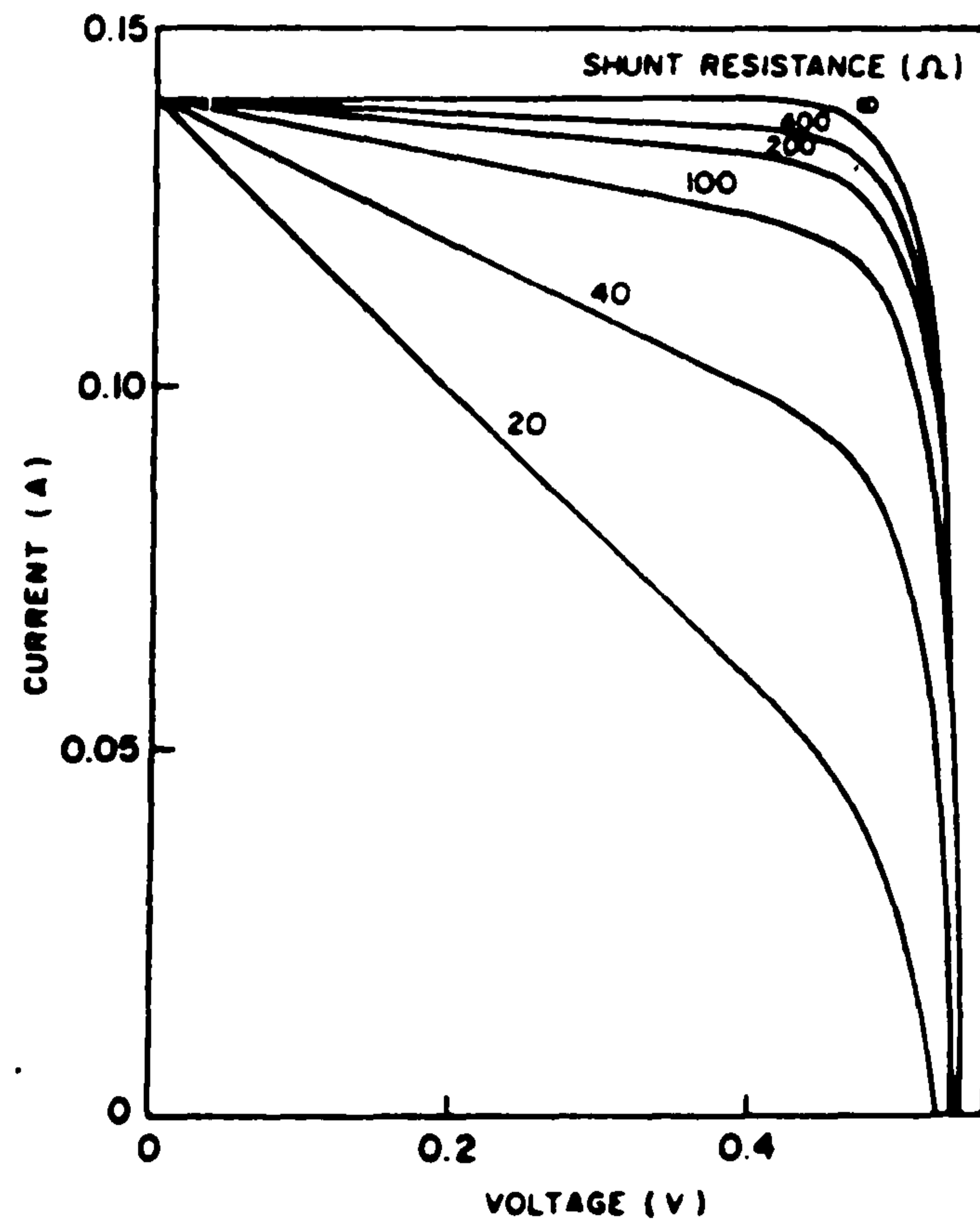

Figure 1.11: Effect of shunt resistance on the I-V curve shape, from source [45].

### 1.2.2.1.2 External Parameters

#### .The Solar Irradiance

Figure 1.12 represents the influence of solar irradiance intensity on a solar cell current and voltage output characteristics at a constant cell temperature. From it, it can be seen that:

- . At a low level of irradiance, the short-circuit current  $I_{SC}$  is proportional to the solar irradiance;
- . The open-circuit voltage  $V_{OC}$  increases slightly with increasing irradiance;
- . The optimal power of the cell is proportional to the irradiance.

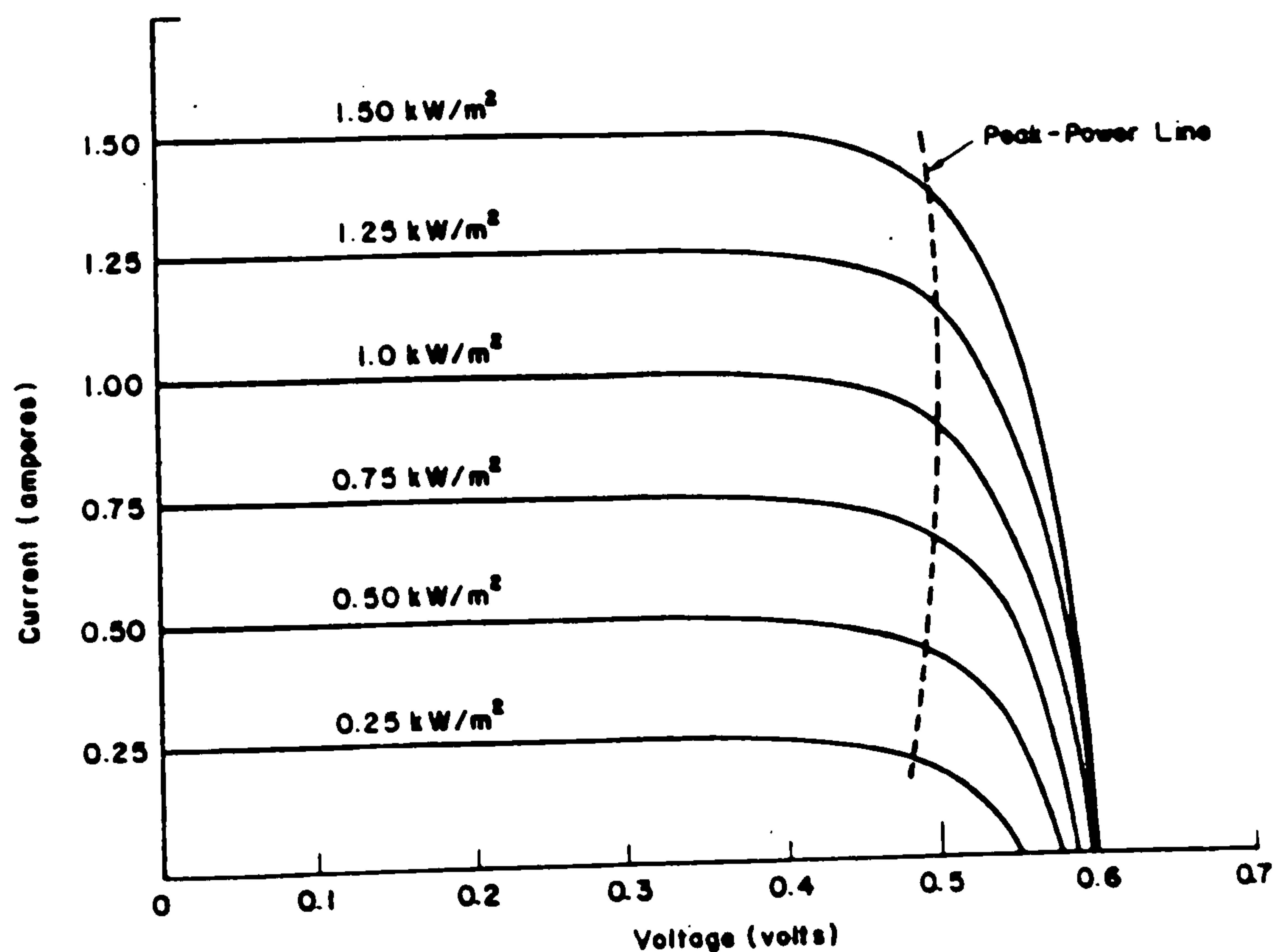

Figure 1.12: Influence of solar irradiance on a solar cell current and voltage output characteristics at a constant cell temperature, from source [45].



### **.The Temperature**

The light generated current,  $I_L$ , will increase slightly with increasing cell temperature (T) by about  $0.1\% \text{ } ^\circ\text{C}^{-1}$  [45]. The slight increase in the light generated current arises from a decrease in the band-gap energy  $E_g$  of the material as the temperature increases, according to [45]:

$$E_g(T) = E_g(0) - \frac{aT^2}{T+b}, \quad (1.7)$$

where  $E_g$  represents the band-gap and a and b are materials constants. The open-circuit voltage would decrease linearly with increasing cell temperature owing to the exponential increase in saturation current. The saturation current is a current of minority carriers created by thermal excitation. Its variation with temperature can be expressed as:

$$I_o = A_o T^3 \exp\left(-\frac{E_g}{k_B T}\right), \quad (1.8)$$

where  $A_o$  is a constant. Therefore, the influence of temperatures on solar cells can be summarised as follows:

- (i) The open-circuit voltage  $V_{OC}$  would decrease by about  $2 \text{ mV}^\circ\text{C}^{-1}$  between 20 and  $100 \text{ } ^\circ\text{C}$  [45].
- (ii) The maximum available power or the efficiency will decrease by  $0.35\%^\circ\text{C}^{-1}$  to  $0.5\%^\circ\text{C}^{-1}$  [10] approximately and therefore there is a proportional decrease in maximum efficiency (see Figure 1.13).

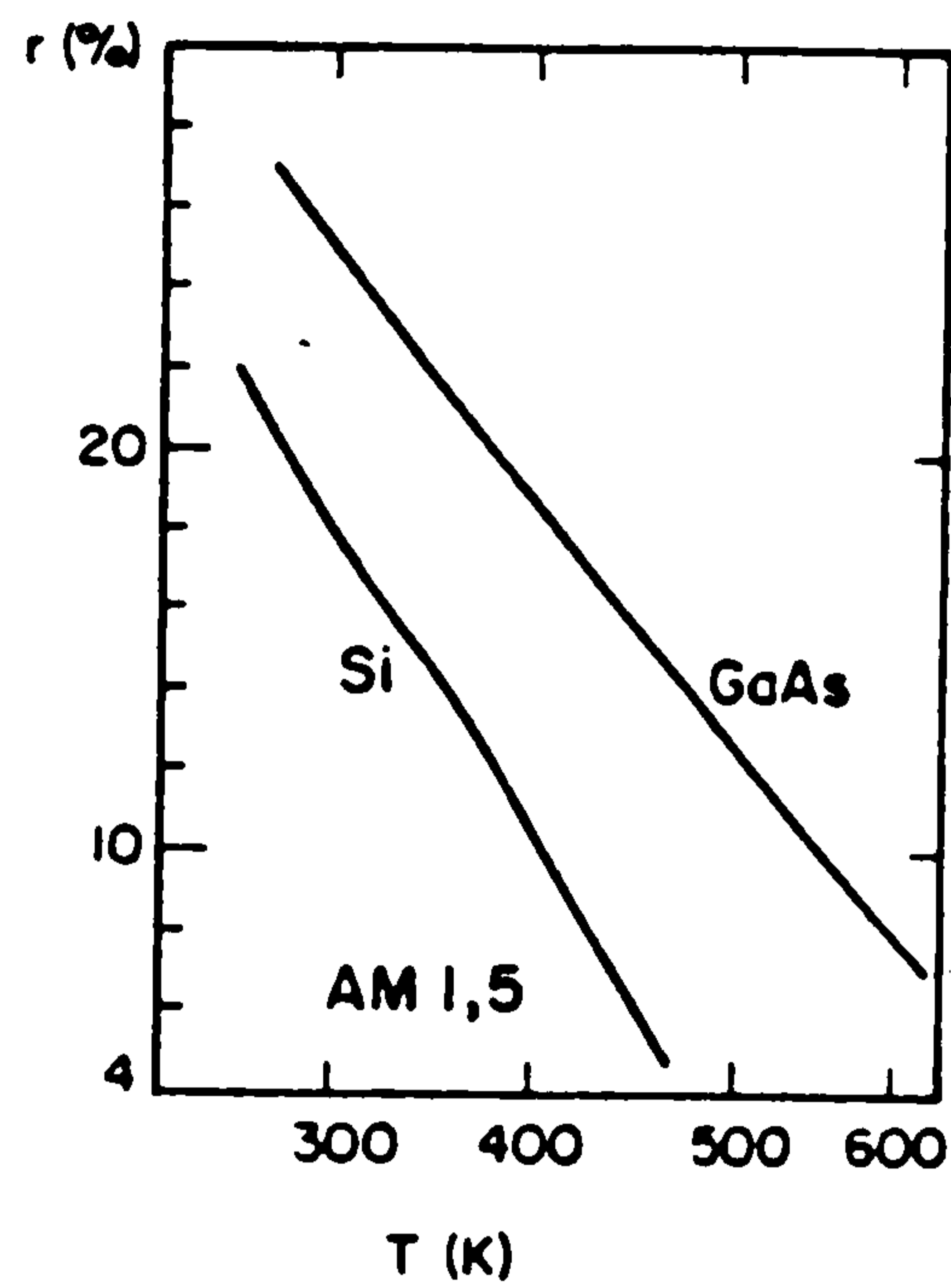

Figure 1.13: Typical influence of temperature on solar cell efficiency, from source [45].

The maximum efficiency can be expressed as follows [45]:

$$\eta(XE_s, T) = \eta(E_s, T_o) \left[ 1 - \beta(T - T_o) \right] \left( 1 + \frac{k_B T \ln X}{eV_{oc}(E_s, T_o)} \right), \quad (1.9)$$

where  $X$  is the concentration factor of solar irradiance.

### 1.2.3 The PV Array

The output of a single solar cell is rarely useful, so they are usually strung in series. For example, about 30-36 cells would be connected together in series to produce a voltage of 14-18 volts so as to be able to charge a 12 V battery. An assembly of cells in this way, with an appropriate protective case is called a PV module. Modules, in turn, can be connected in series and/or in parallel to form a PV array. For cells connected in series the output voltage is calculated by multiplying the cell's voltage by the number of cells, and the current is equal to that delivered by each cell. For cells connected in parallel, the output voltage is equal to that of each cell and the output current is found by multiplying the yield of each cell by the number of cells. Figure 1.14 represents examples of association of cells in series and parallel.

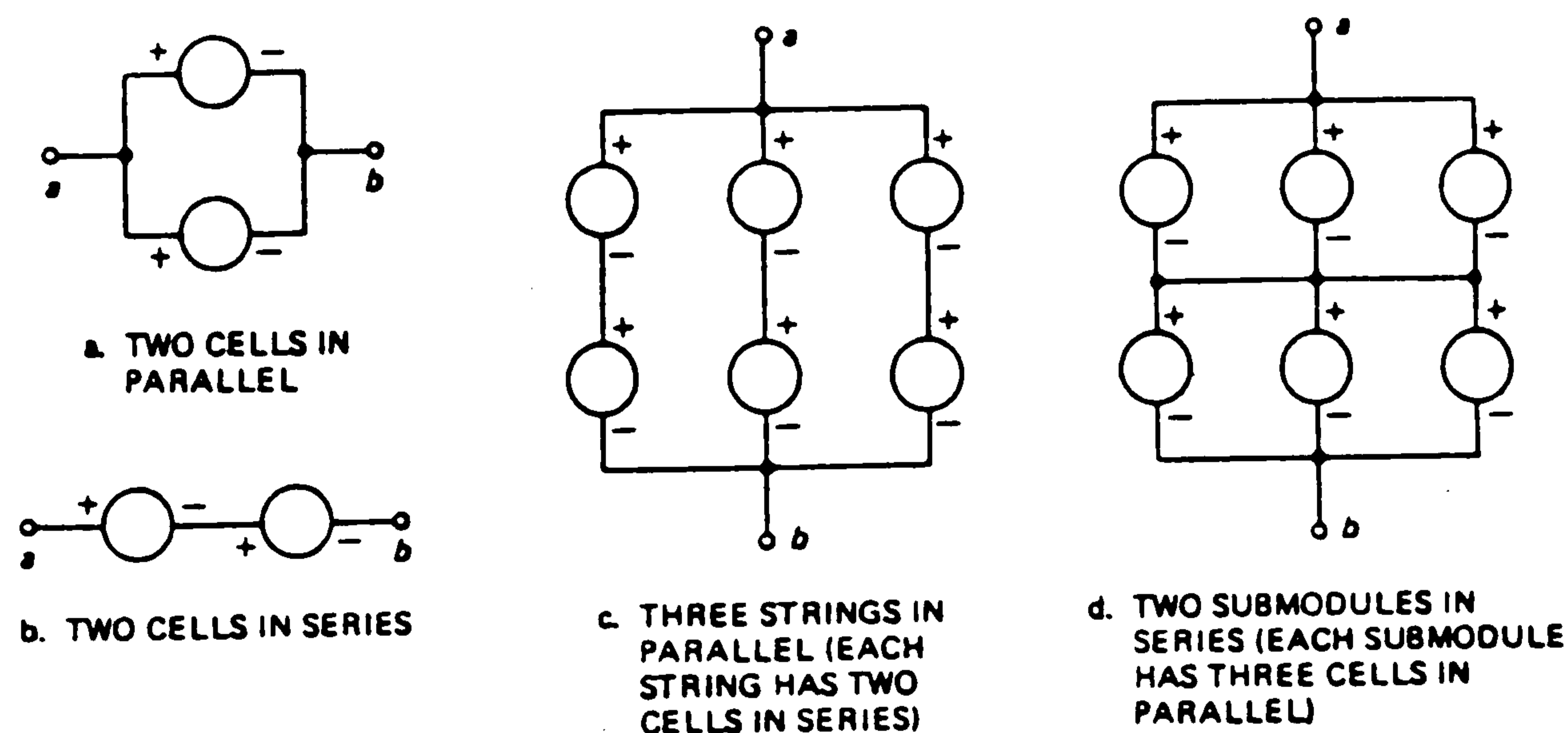

Figure 1.14: Examples of cells connected in series and parallel.

### **1.3. Solar Radiation**

The sun is a gigantic thermonuclear reactor emitting energy from its surface approximately like a blackbody radiator at 6000 K. The emitted energy is mainly in the form of electromagnetic radiation, ranging from about 30 m short-wave radio waves to  $10^{-10}$  m x-rays [1, 46-51]. However, most of the solar energy is in the visible and near-infrared wavelength range. The sun is responsible for a series of phenomena called solar activity. Sunspots, solar flares, are some of the manifestations of solar activity. These phenomena have influence to the terrestrial environment. Figure 1.15 shows the structure of the sun.

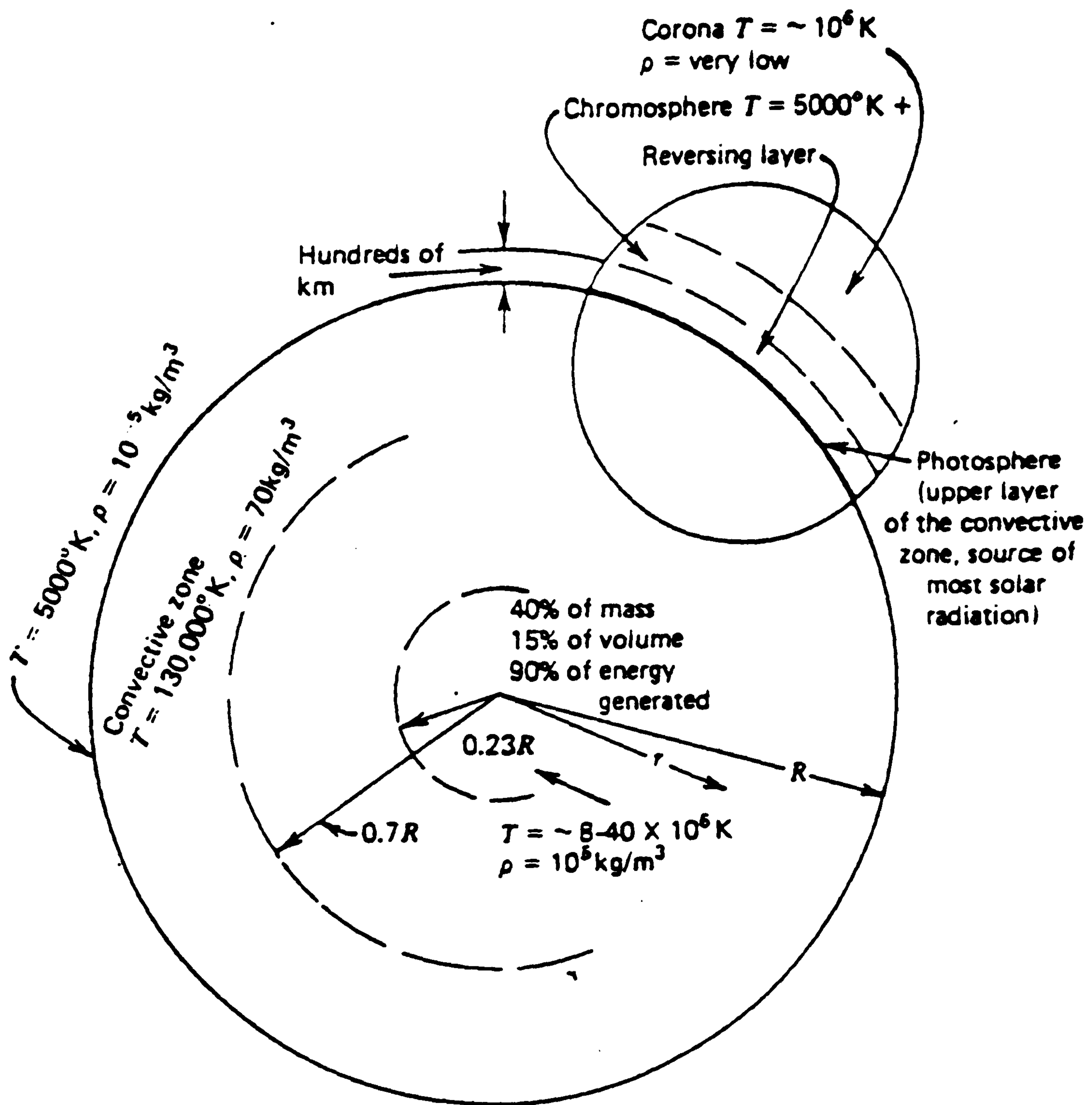

Figure 1.15: The structure of the sun, from source [46].

The blackbody spectrum of the sun's surface is modified by the variation in temperature across the sun's disk, the effect of the solar atmosphere and Fraunhofer absorption lines. Figure 1.16 shows the solar spectrum outside the atmosphere and Figure 1.17 compares a smoothed solar spectrum to various blackbody curves.

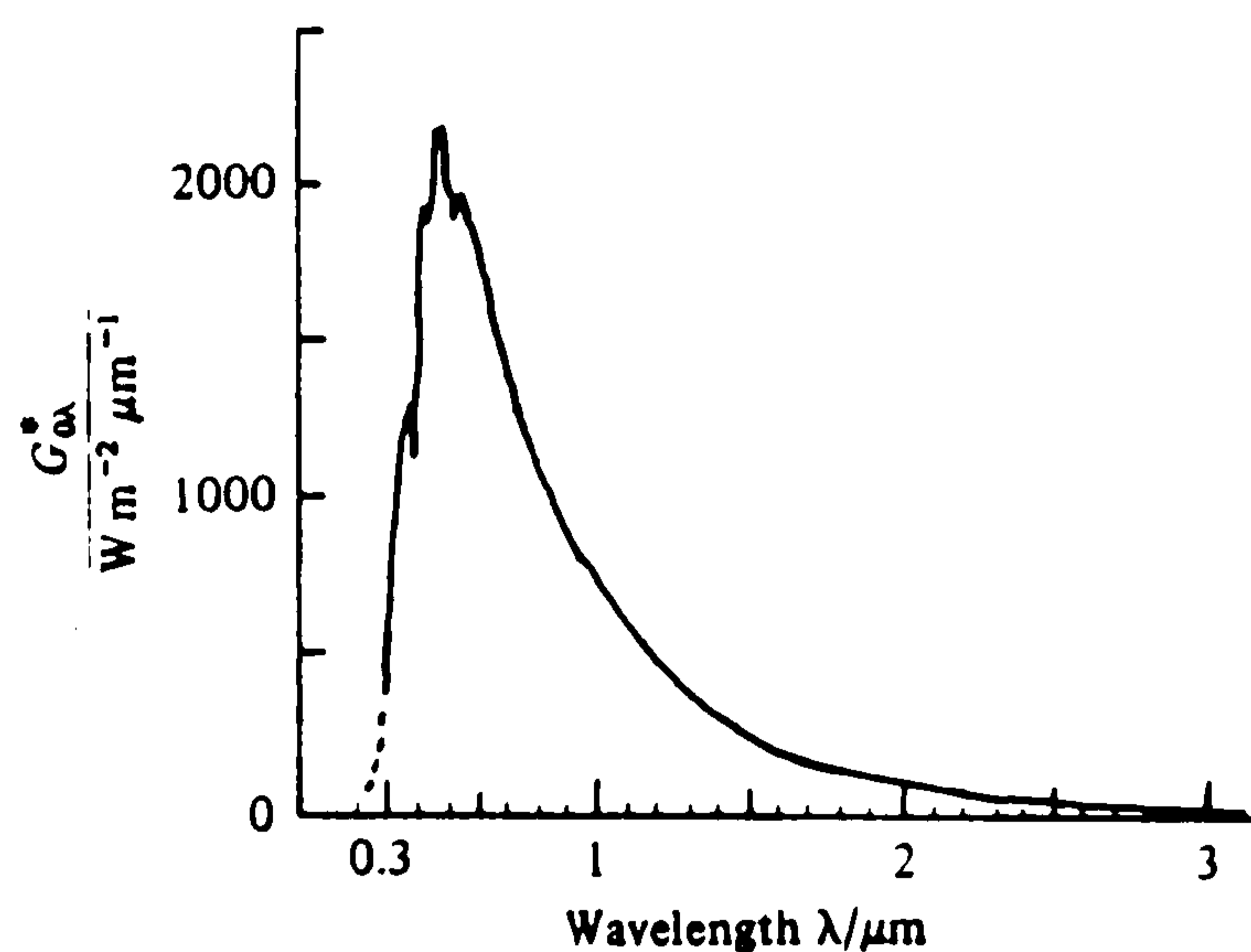

Figure 1.16: Spectral distribution of the extraterrestrial solar irradiance  $G^*_{0\lambda}$  (NASA standard curve, NASA, 1971), from source [1].

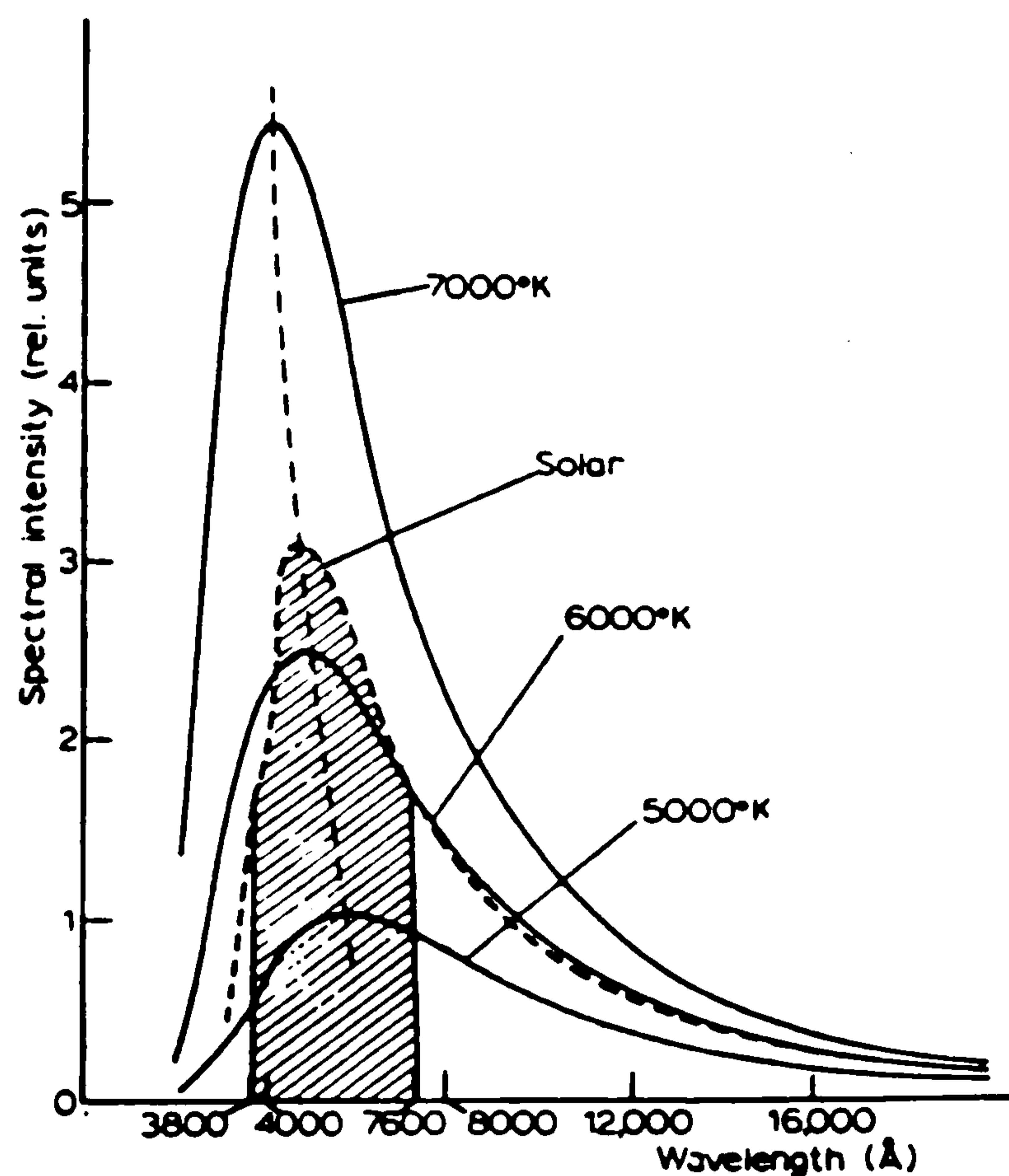

Figure 1.17: Spectral distribution of the sun's radiation compared with blackbody distributions corresponding to different temperatures, from source [38].

In outer space, 98% of the total energy radiated by the sun lies between 0.25 and 3.0  $\mu$  m. A quantity called the solar constant is defined as the rate at which energy is received on a unit surface, perpendicular to the sun's direction, in free space at the earth's mean distance from the sun; the most recently accepted value is 1.353 kWm<sup>-2</sup> [38,51]. The actual solar radiation in free space at the earth's mean distance from the sun differs from this value by  $\pm 3.35\%$  because of the predictable changes in the earth-sun distance throughout the year arising from the earth's slightly elliptic path [1]. There are also fluctuations in the sun's radiant output, which account for variations of about  $\pm 1.5\%$  [1]. The extraterrestrial solar spectrum, which is in the range of short wave radiation, can be divided into three main regions:

- . Ultraviolet region ( $\lambda < 0.4 \mu\text{m}$ ): 9% of the irradiance;
- . Visible region ( $0.4 \mu\text{m} < \lambda < 0.7 \mu\text{m}$ ): 45% of the irradiance;
- . Infrared region ( $\lambda > 0.7 \mu\text{m}$ ): 46% of the irradiance.

Both the intensity and the spectral distribution of the radiation arriving at the earth's surface depend on the composition of the atmosphere, as well as the pathlength of the radiation through the atmosphere. The most important parameters of the atmosphere are the water content, the effect of haze and related scattering, the ozone content, the cloudiness of the sky and the effect of ground reflection. Geometric effects, such as the sun's declination angle, are manifested by varying the pathlength through the atmosphere. Considering only direct radiation on a receiver pointing directly towards the sun, these geometric effects can be almost completely described by specifying a zenith angle of the sun, the angle between the earth-sun radius and the normal of a plane containing the horizon circle, as illustrated in Figure 1.18. This zenith angle  $z$  is a function of the time of day, the season, the latitude and the longitude. At real solar noon,  $z$  is given by the following expression:

$$z=L- 23.5^{\circ}\cos(360N/365), \quad (1.10)$$

where  $N$  is the number of days since the summer solstice, and  $L$  represents the latitude of the place, in degrees. The pathlength through the atmosphere is conveniently described in terms of an equivalent relative air mass  $m_r$ . The pathlength for a zenith angle  $z$  is just  $\sec z$  times the pathlength for  $z=0$ , and this relative air mass  $m_r$  is defined as  $m_r=\sec z$ . Specific solar spectra are labelled  $AMm_r$ .  $AM0$  corresponds to the solar spectrum in outer space; the average solar spectrum at the earth's surface corresponds approximately to  $AM2$ . In Figure 1.19,  $AM0$  and  $AM2$  spectra are compared. In photovoltaic research for terrestrial applications the air mass is normally taken as  $AM1.5$  [38].



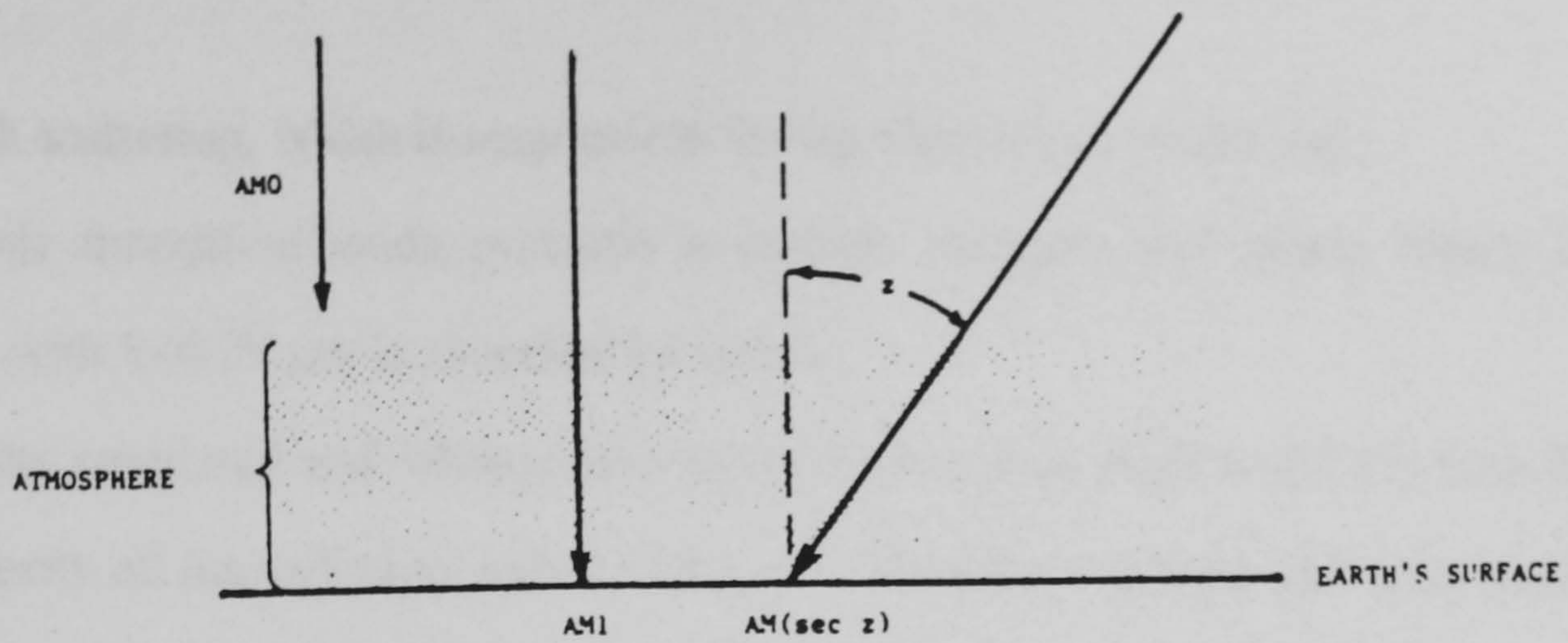

Figure 1.18: Illustration of the solar radiation spectrum labelled AM0 in space, AM1 at the earth's surface for normal incidence, and  $AM_m$  at the earth's surface with  $m = \sec z$ , where  $z$  is the deviation from normal incidence, from source [38].

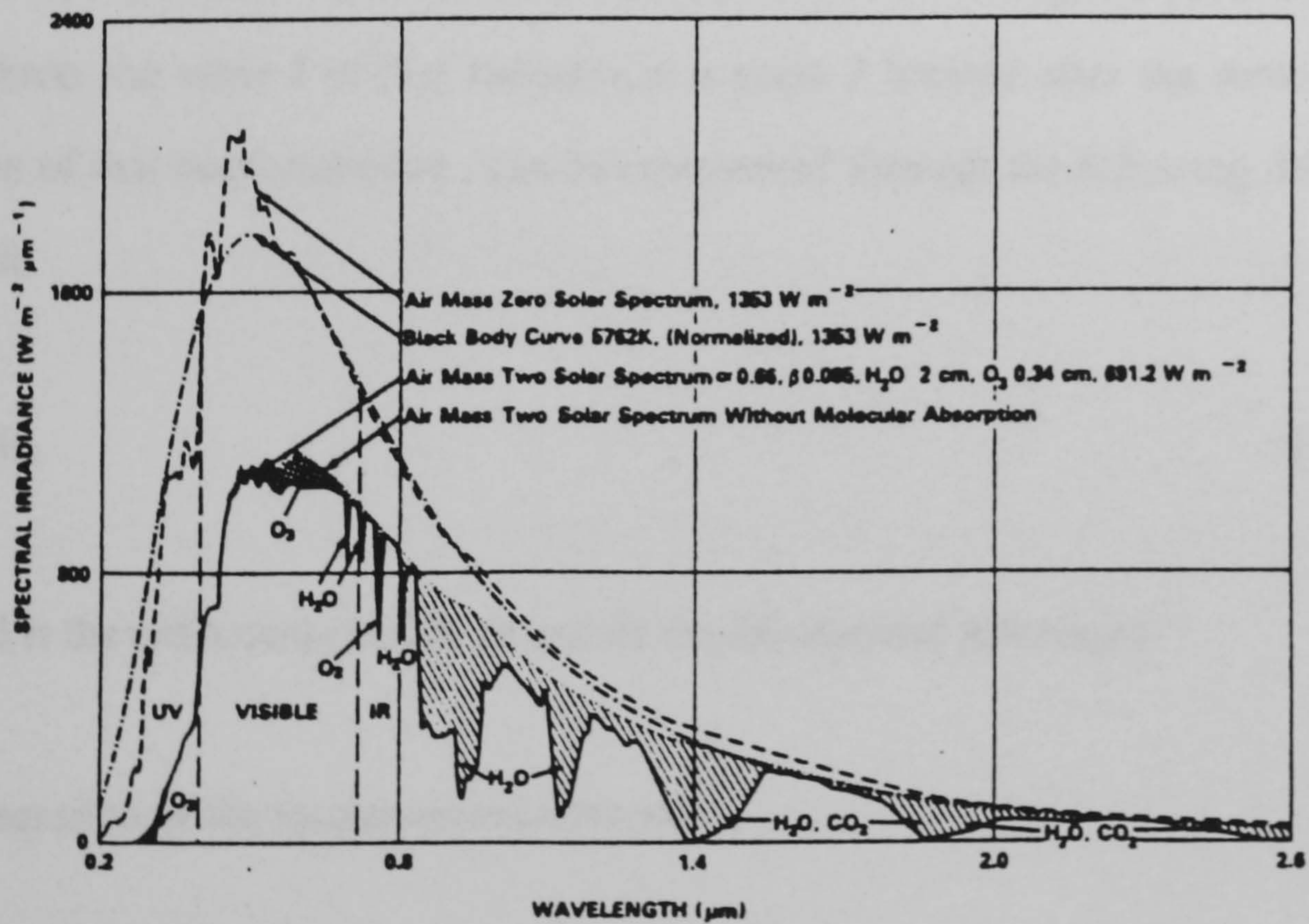

Figure 1.19: Comparison of AM0 and AM2 solar spectra, showing the various atmospheric absorption bands in AM2, from source [38].

On its path through the atmosphere, the sunlight is modified by the following processes:

- . Rayleigh scattering, which is responsible for the blue colour of the sky;
- . Electronic absorption bands, primarily in oxygen, nitrogen, and ozone. Nearly all the radiation with  $\lambda < 0.29 \mu\text{m}$  is absorbed by ozone;
- . Molecular rotational and vibrational absorption bands in  $\text{H}_2\text{O}$  and  $\text{CO}_2$  (see Figure 1.19). Nearly all the radiation with  $\lambda > 3.0 \mu\text{m}$  is absorbed by  $\text{H}_2\text{O}$  and  $\text{CO}_2$  (with the exception of the so-called atmospheric windows at much longer wavelengths);
- . Scattering by aerosols and particulate matter, which is greater for the shorter wavelengths;
- . Refraction and turbulence due to variations in the index of refraction with temperature and pressure.

Thus, if  $J_0$  represents a certain value of solar radiation at a given point  $P_0$  in the atmosphere, the value  $J$  of that radiation at a point  $P$  located after the former in the direction of that beam radiation, can be represented through the following differential equation:

$$dJ = -J\beta ds, \quad (1.11)$$

where  $\beta$  is the extinction coefficient and  $ds$  the infinitesimal pathlength.

The integration of the former expressions yields:

$$J = J_0 \cdot e^{-\beta s} = J_0 \cdot t_G. \quad (1.12)$$

$t_G = e^{-\beta s}$  is the transmission factor.

The total radiation that falls upon an horizontal or inclined surface is called global radiation. The global radiation  $G$  is the sum of the direct radiation  $J$  and of the diffuse (also called sky) radiation  $D$ :

$$G=J+D. \quad (1.13)$$

The diffuse radiation is a result of scattering processes in the sky and also of reflections of sunlight in clouds and on the earth's surface. The diffuse radiation in cloudless conditions is strongly peaked in the blue portion of the spectrum and contributes about 8-10% of the total radiation on a fairly clear day at noon and considerably more at greater zenith angles.

### References

- [1] J. W. Twidell and A. D. Weir "Renewable Energy Resources, E. and F. N. Spon, London, 1986.
  
- [2] P. D. Dunn "Renewable Energies: Sources, Conversions and Applications", Peregrinus Ltd., London, 1986.
  
- [3] Thomas B. Johansson et al. (Editors) "Renewable Energy Sources for Fuel and Electricity", Earthscan Publications Ltd., London, 1993.
  
- [4] G. Furlan et al. (Editors) "Physics of Non-Conventional Energy Sources and Material Science for Energy", I.C.T.P., Trieste, 1985.
  
- [5] F. Treble "Generating Electricity from the Sun", Pergamon Press, 1991.

[6] WMO, UNEP "Radiative Forcing of Climate Change: The 1994 Report of the Scientific Assessment Working Group of Intergovernmental Panel on Climate Change (IPCC)", 1994.

[7] National Meteorological Services "Climate of Europe: Recent Variation, Present State and Future prospects", First European Climate Assessment, European Climate Support Network (ECSN), 1995.

[8] D. W. Devins "Energy - Its Physical Impact on the Environment", J. Wiley, Chichester, 1982.

[9] J. H. Fowler "Energy and the Environment", Second Edition, McGraw-Hill, London, 1984.

[10] Berry Van Gelder and Phil O'Keefe "The New Forester", IT Publications, London, 1995.

[11] Sam Moyo, Phil O'Keefe and Michael Sill "The Southern African Environment", Earthscan Publications Ltd., London, 1993.

[12] D. Hislop (Editor) "Energy Options: An Introduction to Small Scale Renewable Energy Technologies", IT Publications, London, 1992.

[13] V. Bokalders and L. Kristofersen "Renewable Energy Technologies: Their Applications in Developing Countries", IT Publications, London, 1991.

[14] M. Imran and P. Barnes "Energy Demand in Developing Countries: Prospects for the Future", IT Publications, London, 1990.

- [15] G. Foley "Electricity for Rural People", IT Publications, London, 1990.
- [16] C. Hurst and A. Barnett "The Energy Dimension: A Practical Guide to Energy in Rural Development Programmes", IT Publications, London, 1990.
- [17] Barry Munslow et al. "The Fuelwood Trap: A Study of the SADCC Region", Earthscan Publications, London, 1988.
- [18] UNDP "Human Development Report 1991", Oxford University Press, Oxford, 1991.
- [19] M. R. Bhagavan "The Energy Sector in SADCC Countries: Policies, Priorities and Options in the Context of the African Crisis, Research report No. 74, Scandinavian Institute for African Studies, Upsala, 1985.
- [20] Barry Munslow "Mozambique", in Energy, Environment and Development in Africa, Band 4, Edited by Phil O' Keefe and Barry Munslow, 1984.
- [21] R. Hill "Photovoltaics in Developing Countries", Proceedings of the 9th EC PVSEC, Freiburg, Germany, October 1989, Pages 949-954.
- [22] A. Derrick et al. "Solar Photovoltaic products: A Guide for Development Workers", IT Publications, London, 1991.
- [23] R. Barlow et al. "Solar Pumping", IT Publications, London, 1993.
- [24] J. P. Louieneuve "Rural Lighting", IT Publications, London, 1994.

- [25] W. Hulscher and P. Fraenkel "The Power Guide", IT Publications, London, 1994.
- [26] R. Hill "Review of Photovoltaics", Paper Prepared for the Royal Institute of International Affairs, Newcastle Photovoltaics Applications Centre, Newcastle Upon Tyne, 1989.
- [27] M. E. Becquerel "Mémoire sur les Effects Électriques Produits sous l' Influence des Rayons Solaires", C. R. Acad. Sci. Paris, Volume 9, 1839, Pages 561-567.
- [28] Bundesministerium für Forschung und Technologie (Editor) "Erneuerbare Energien: Stand, Aussichten und Forschungsziele" Bonn, 1992.
- [29] M. Dehli "Energie von der Sonne", Informationszentrale der Elektrizitätswirtschaft e. V., Bonn, 1981.
- [30] M. A. Green and K. Emery "Solar Cell Efficiency Tables", Progress in Photovoltaics: Research and Applications, Volume 1, 1993, Pages 25-29.
- [31] M. A. Green and K. Emery "Solar Efficiency Tables (Version 2)", Progress in Photovoltaics: Research and Applications, Volume 1, 1993, Pages 225-227.
- [32] R. Mertens "Silicon Solar Cells", Proceedings of the 12th EC PVSEC, Amsterdam, The Netherlands, April, 1994, Pages 1-6
- [33] M. A. Green "Crystalline and Polycrystalline Silicon Solar Cells", in Renewable Energy, Sources for Fuel and Electricity, Edited by T. B. Johansson et al., Earthscan Publications Ltd., London, 1993, Pages 337-360.

[34] W. Palz, R. Van Overstraeten and G. Palmers "PV-Programmes of the European Commission", Proceedings of the 12th EC PVSEC, Amsterdam, The Netherlands, April 1994, Pages 1441-1444.

[35] J. E. Rannels "Building on Success: The United States Photovoltaic Program", Proceedings of the 12th EC PVSEC, Amsterdam, The Netherlands, April, 1994, Pages 1445-1448.

[36] Kenichi Toma and Seiji Wakamatsu "The New Sunshine Programme in Japan", Proceedings of the 12th EC PVSEC, Amsterdam, The Netherlands, April 1994, Pages 1449- 1450.

[37] R. Hill "Solar Cells", Internal Report, Newcastle Photovoltaics Applications Centre, 1994.

[38] A. L. Fahrenbruch and R. H. Bube "Fundamentals of Solar Cells: Photovoltaic Solar Energy Conversion", Academic Press, Inc., 1993.

[39] H. S. Rauschenbach "Solar Cell Array Design Handbook" (New York: Van Nostrand-Reinhold), 1980.

[40] J. A. Duffie and W. A. Beckman "Solar Engineering of Thermal Processes", John Wiley & Sons, Inc., 1980.

[41] M. A. Green "Solar Cells: Operating Principles, Technology and System Applications", Prentice Hall, New Jersey, 1982.

[42] G. E. McGuire (Editor) "Semiconductor Materials and Process Technology Handbook", Noyes, Park Ridge, Illinois, 1988.

- [43] Meudon "Solar Cell Technology" Proceedings of the Workshop on Planning of Network Projects in Materials Science and Solar Energy, Arusha, 1988.
- [44] R. J. Van Overstraeten and R. P. Mertens "Physics, Technology and Use of Photovoltaics", Adam Hilger, 1986.
- [45] F. Lasnier and T. G. Ang "Photovoltaic Engineering Handbook", Adam Hilger, 1990.
- [46] G. P. Kuiper (Editor) "The Sun", University of Chicago Press, Chicago, 1954.
- [47] Global Climate Change, The Department of the Environment in Association with The Meteorological Office, UK 1989.
- [48] M. Scheibe "Grundlagen der Angewandten Geomagnetik", Teil I, Bergakademie Freiberg, Sektion Geowissenschaften, 1979.
- [49] J. R. Apel, S. F. Singer and R. C. Wentworth "Effects of Trapped Particles on the Geomagnetic Field", Advances in Geophysics Volume 9, 1962, Pages 131-189.
- [50] V. Mezentsev "Enciclopédia das Maravilhas (Translated from Russian)", Editora MIR, 1986.
- [51] A. Goetzberger and V. Wittwer "Sonnenenergie: Thermische Nutzung", Teubner Studienbücherei, 1989.



## **Chapter 2**

# **The State-Of-The-Art of Solar Cell Technologies**

## 2.1 Introduction

Although the photovoltaic (PV) effect was first demonstrated in 1839, practical applications of photovoltaics began in the early 1950's, when solar cells were adopted by the United States space programme. The first solar cell to enter space was installed on Vanguard I, the second US satellite launched into orbit in 1958. The programme spawned a number of innovations, and as prices fell commercial producers were able to sell PV systems for a growing number of land-based terrestrial applications [1-3].

Presently the major barrier to widespread adoption of photovoltaic equipment is its high cost. Solar electricity capacity costs now about US\$5/W<sub>p</sub> and solar cells/modules account for about 50-60% of the overall PV systems costs [4-10]. PV will be competitive with the most conventional systems when its electricity capacity will cost around US\$2/W<sub>p</sub>. A number of strategies for reducing solar cells costs is being actively pursued around the world. Costs reductions are being sought in four major directions: (i) through reducing the large amounts of solar cells materials, (ii) selecting less labour- and energy- intensive processes, (iii) looking into alternative cheaper manufacturing equipment and (iv) investigating novel materials.

There are basically two technological processes for manufacturing solar cells [11-18]: one is based on ingots of crystalline silicon materials (both mono crystalline and poly) and the other consists of depositing a thin film of a semiconducting material onto a substrate (for example, amorphous silicon and cadmium telluride solar cells). Thin film technology to produce solar cells was developed with the belief that much less material would be required for the production of solar cells (the layer of a thin film is about 1-10 μm, against about 100-400 μm of that of a crystalline cell); on the other hand the production processes of thin film solar cells were promising to be much cheaper.

Another way which could contribute to reduced costs of PV electricity is that of concentrating the solar radiation before reaching the cell [19-21], since the solar efficiency of photovoltaic cells generally increases with illumination intensity, at constant temperature, and less PV material is required. For higher concentration ratios, the concentrator itself begins to dominate the system cost, thus allowing expensive, high-efficiency cells to be used economically to increase system efficiency. For this purpose, special cells, which can withstand high temperatures without much degradation are required. Such cells are known as concentrator solar cells, which generally require a dynamic focusing and cooling.

This chapter discusses the state-of-the-art of some solar cells materials and devices, in terms of their manufacturing technologies, their major problems and the prospects for future developments. The technology of assembling cells into modules is also addressed, as well as the environmental issues associated with the use of PV.

## **2.2 Single-and Polycrystalline Silicon Solar Cells**

Although silicon is not the ideal material for solar cells, it has the benefit of being the basis of the electronics industry [22-28]. It is one of the best understood and most intensively researched elements in the periodic table [28], and the science and technology of silicon, developed for the electronics industry is transferable to solar cells. Silicon is found in sand, a very plentiful material. The photovoltaic industry predominantly uses crystalline silicon technology. In 1993, 77% of all world-wide PV shipments were based on crystalline silicon modules. It is also generally believed that this technology has still a large potential for higher performance and lower costs. Typical conversion efficiencies of industrial silicon solar cells are in the range of 13 to 15%. The required future efficiency goals are 18 to 20% on Czochralski monocrystalline silicon and 16 to 18% on multicrystalline silicon. Such high efficiencies are necessary in order to meet the cost goal of 2 US\$/W<sub>p</sub>.

The silicon solar-cell-manufacturing process involves basically three stages: (i) material preparation and shaping, (ii) cell processing and (iii) cell interconnection and encapsulation. The conventional technological process of manufacturing silicon crystal solar cells, the flow chart of which is presented in Figure 2.1, relies conventionally on the high purity semiconductor-grade silicon (SG-Si) available from electronics industry wastes. Pure silicon materials with good crystallographic quality are required as the starting point for the production of cells. Although the quality standards in this area are not as severe as they are for microelectronics, the same techniques have been used to take advantage of economy-of-scale.

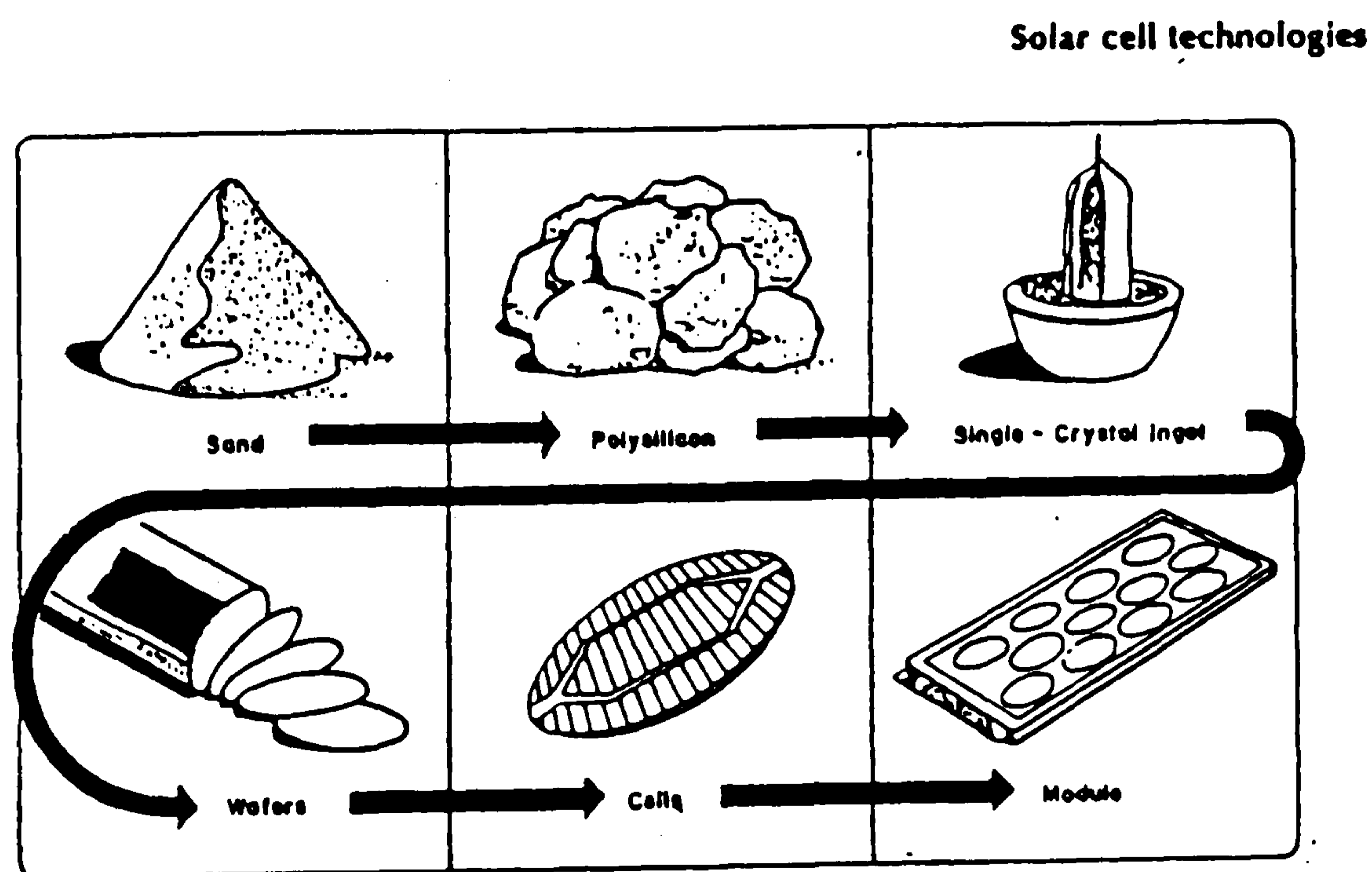

Figure 2.1: Solar-cell-manufacturing process, from source [23].

In this process, quartzite as a raw material is reduced into metallurgical-grade silicon (MG-Si), the purity of which lies in the 98-99% range. MG-Si is purified to qualify as the so-called semiconductor grade silicon (SG-Si) or electronic-grade silicon (EG-Si). SG-Si is then melted in a crucible and pulled out to form a single-crystal silicon ingot by using the traditional Czochralski (CZ) technique (Figure 2.2). The method involves drawing a cylindrical crystal from a melt of silicon with an appropriate seed. This well established crystal growing technique consists of dipping a small seed crystal into molten silicon material. Dopant (e. g. boron acceptors for p type) is added to the melt. Slowly a large cylindrical crystal is mechanically pulled upwards. Ingots that are 15 or 20 centimetres in diameter and about 1.5 metres long are routinely produced by this technique. The grown crystals are then sliced into individual wafers, about 0.5 mm thick, using an inner-diameter slicing technique, (Figure 2.3). A 15 cm diameter wafer can be cut into 10cmX10cm squares whilst the 20 cm diameter wafer can be cut to 14cmX14cm squares. Wafers are etched to remove the damage induced during the slicing operation. Wafers are then processed into a complete solar cell by establishing the junction by diffusion of a n type dopant (e. g. phosphorous donors), by establishing the contact and by depositing an anti-reflection coating onto the surface. Finally cells are interconnected to achieve a practically useful voltage and encapsulated into a module by using a lamination technique.

Solar cell manufacturing using the route of single crystal silicon described above is cost intensive. Therefore alternative routes have been investigated intensively. One such route is that of polycrystalline silicon, based on "solar-grade" silicon (SOG-Si). The SOG-Si concept came out of the need for the PV industry to develop a low-cost silicon material to replace the EG-Si material. The development of SOG-Si came about as the result of the apparent insensitivity of medium-efficiency solar cells to the presence of some typical impurities; for example copper and aluminium in n-type and phosphorus and copper in p-type material which can be tolerated in excess of 1 ppm without major cell degradation. Thus, SOG-Si has not to be seen as a second-rate

material but as a specific material for efficient solar cell production. Polycrystalline ingots are produced by the so called casting process. This technique involves the solidification of molten silicon at carefully controlled rates by cooling the silicon in a crucible (Figure 2.4).

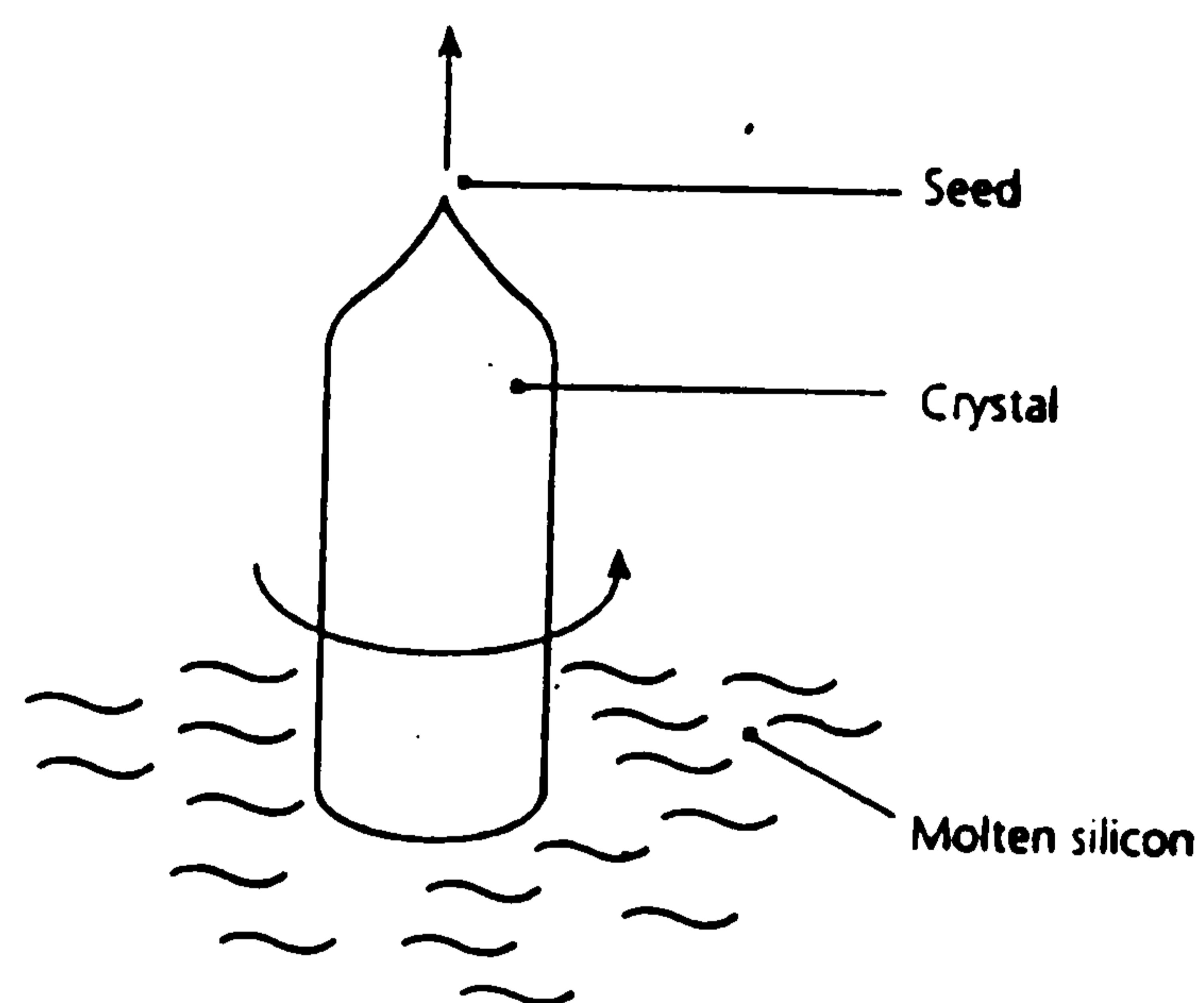

Figure 2.2: The Czochralski crystal growth process for preparing crystalline silicon ingot is shown. A seed crystal is dipped into molten silicon and slowly removed, drawing out the cylindrical crystal. From source [24].

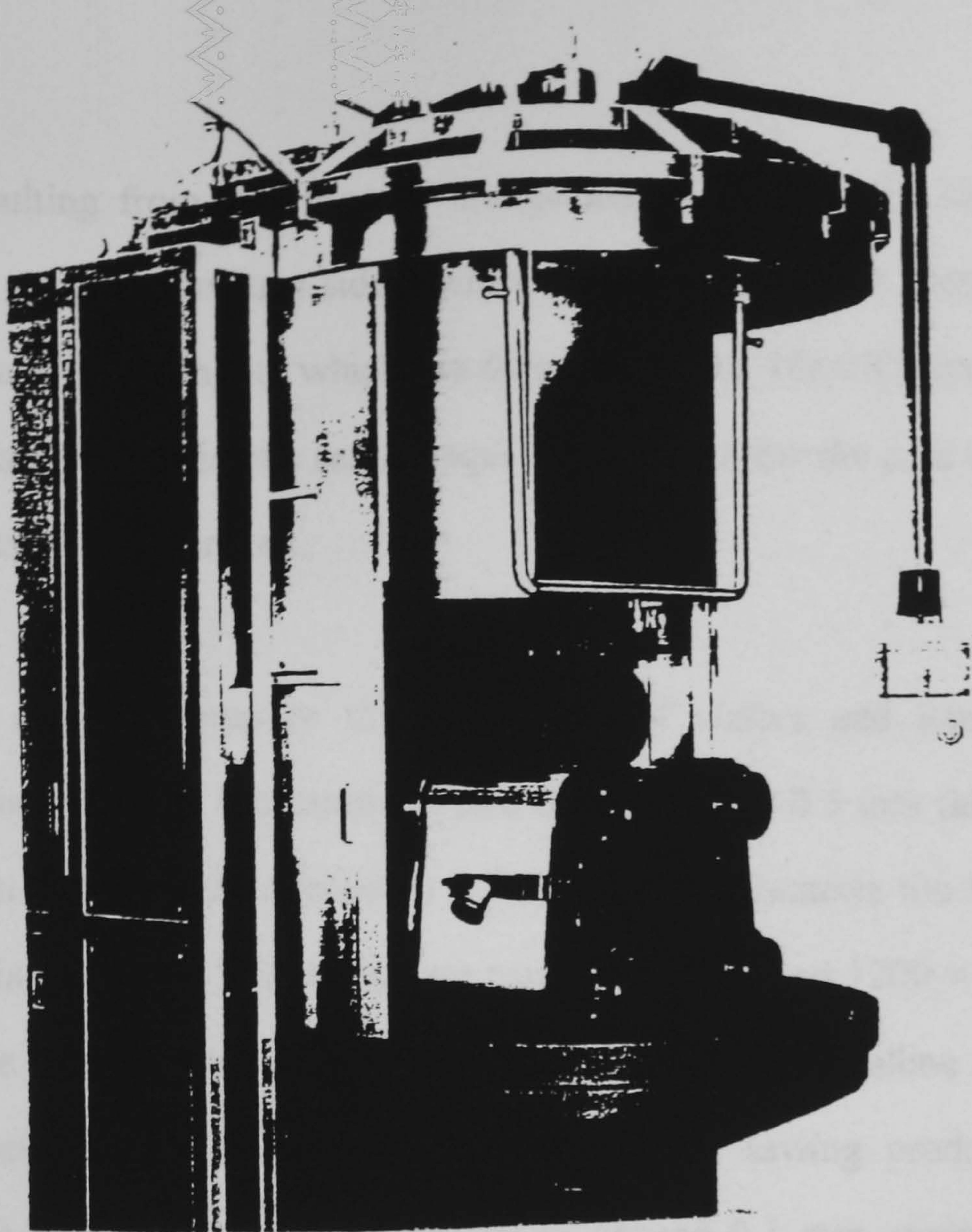

Figure 2.3: Silicon wafers can be cut from grown ingots with an inner-diameter saw.

From source [24].

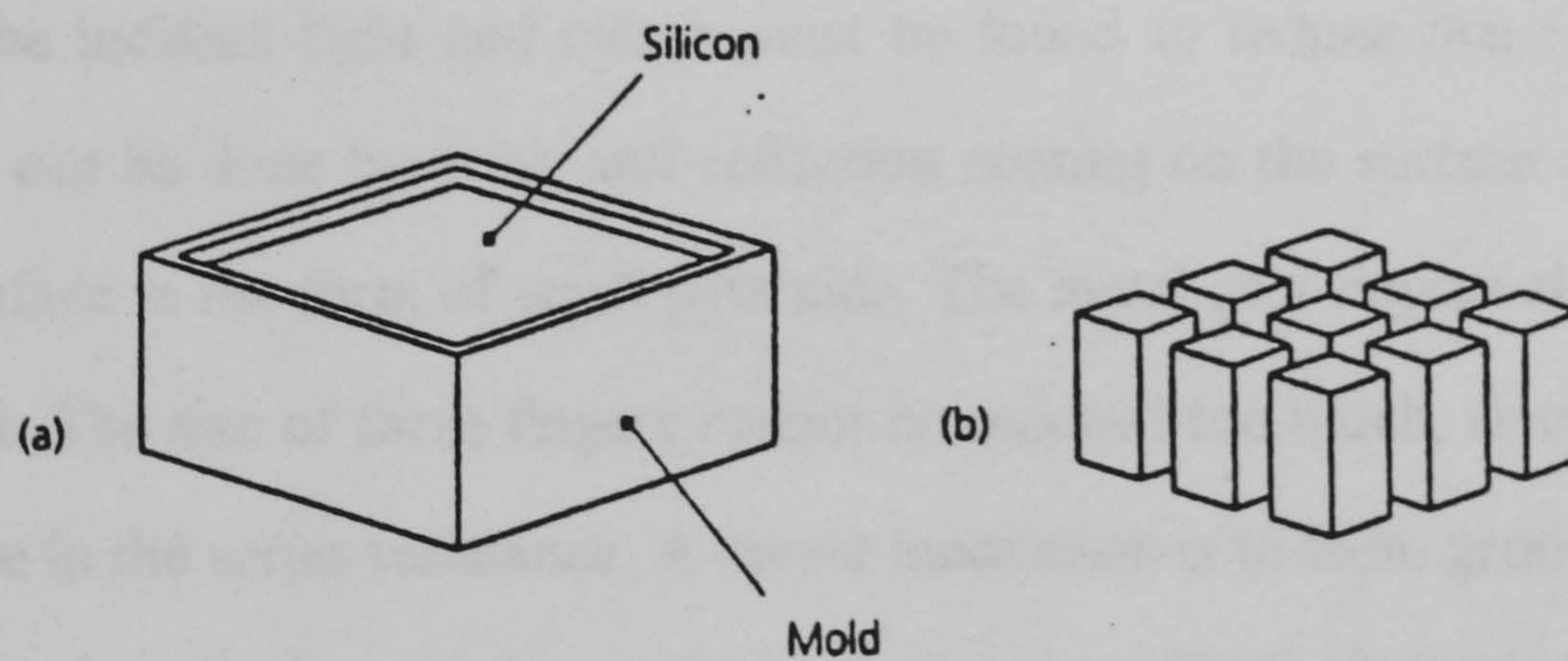

Figure 2.4: (a) Polycrystalline silicon ingots are formed by controlled solidification in a crucible, or mold. The ingots are then cut into smaller sections. (b) Ingots before being cut into wafers. From source [24].

The ingots resulting from this process are generally cubes of 30 centimetres sides (sometimes up to 45 centimetres sides) which are sliced into nine 10cmX10cmX30cm (or 15cmX15cmX45cm) ingots which are then sliced into 10cmX10cm square wafers (or 15cmX15cm). After this, the same stages as described for the case of single-crystal technological route are followed.

The slicing is a crucial step in the production of wafers and hence of cells. A conventional diamond saw is around 0.3 mm thick and cuts 0.5 mm thick wafers. The wafers are then lapped and polished to 0.3 mm thick to remove the surface damage caused by sawing stresses. This technique can produce around 1200 wafers per metre length of boule (ingot). This means that 40% to 50% of crystalline material is lost during this process. The new technique of multiwire sawing produces stress-free wafers about 0.3 mm thick with a kerf-loss of around 0.1 mm, giving around 2400 wafers per metre length of boule. This doubling of wafer production per boule or per ingot has a major effect on reducing the production cost of cells. The wafers are doped p-type during growth and the p-n junction is formed by introducing a thin layer of donors on one surface by diffusion from a gas or paste in a furnace. Silicon reflects about 30% of the incident light and means must be found to reduce this to a value below 5%. This can be done by using anti-reflection coating on the surface and/or by texturing the surface in the form of small pyramids. The metal grid-fingers also reflect the incident light. The size of these fingers cannot be reduced too much, since this can cause an increase in the series resistance. A recent innovation is to form grooves in the cell surface and to deposit the grid-fingers in these grooves, effectively turning them on their side. The metal coverage on the surface is reduced in this way from about 5% to under 1%. With these techniques the total reflections can be reduced to around 2%. Another factor to be considered is that of recombination. The charge carriers generated by the absorption of light can recombine before they cross the junction. The recombination in the bulk of the silicon wafer is reduced by reducing the concentration of impurities which cause recombination. In polycrystalline silicon, the grain



boundaries also act as recombination centres and must be passivated, usually by hydrogen treatment. Surfaces act as recombination centres and are passivated by growing an oxide layer on the surface. Electrical contacts also are sites for recombination and for the most efficient cells, the contact between silicon and metal is restricted to small areas of highly doped silicon with the rest of the silicon surface covered by the passivating silicon oxide. The structure of a silicon cell having all these features is shown in Figure 2.5. Silicon cells which are in commercial production do not usually have all the features shown in Figure 2.5. There is now production of cells with the grooved contacts by BP SOLAR, with cell efficiencies of 17.5% to 18% on 10cmX10cm cells at production rates of around 250,000 cells per annum [28]. The University of New South Wales has a small production line of 7cmX7cm cells with efficiencies in the 19.5%-20% range which they sell for solar powered cars. Other approaches to 20% efficiencies are likely to be common within the next few years. Table 2.1 shows the present efficiencies of the various types of crystal silicon cells with estimates of improvements up to the year 2000.

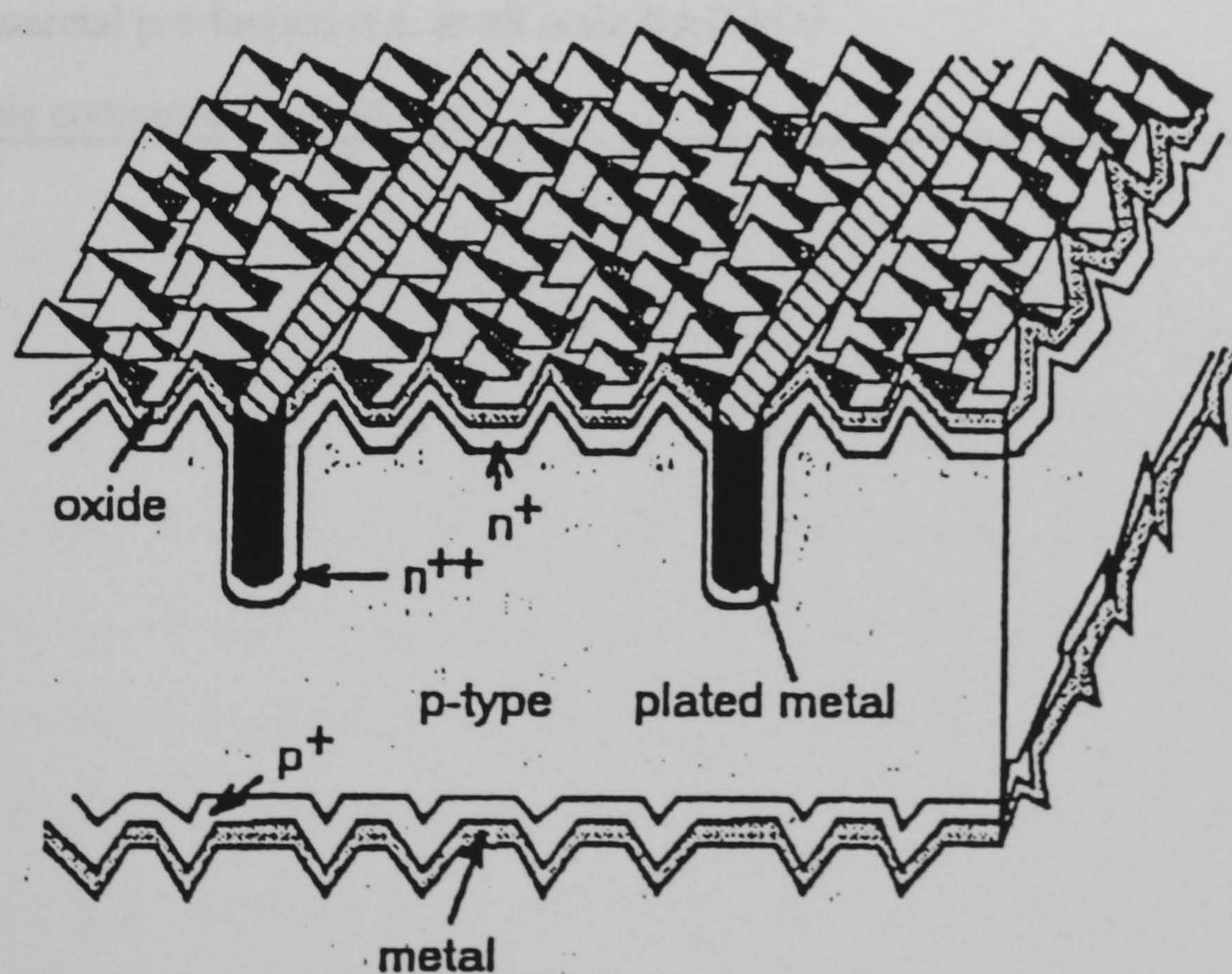

Figure 2.5: Buried contact solar cell from BP Solar, from source [28].

Table 2.1: Efficiencies of crystal silicon cells, from source [28].

	<b>Cell Type</b>	<b>Area (cm<sup>2</sup>)</b>	<b>Record (1992) Efficiencies (%)</b>	<b>Potential (2000) Efficiencies (%)</b>
<b>L</b>	Single Crystal	4	23.1	26
<b>PC</b>	Single Crystal	49	20	23
<b>SC</b>	Single Crystal	100	18	22
<b>L</b>	Multi Crystal	1	17.7	21
<b>PC</b>	Multi Crystal	100	16.4	20
<b>L</b>	Spherical Cells	10	11.5	14
<b>L</b>	Thin Film Epi	1	14.9	20
<p><b>L = Best cells produced in research laboratories</b></p> <p><b>PC = Pre-commercial production (i.e. small scale R&amp;D&amp;D)</b></p> <p><b>SC = Small scale commercial production</b></p>				

Both the technological routes of single- and polycrystalline solar cells offer a very wide room for innovative work. It is not clear up to now which material (mono or poly) will dominate the market in the coming years. A recent study by Siemens Solar [22] indicates that, contrary to previous beliefs, mono crystalline silicon is capable of achieving module costs in the US\$2/W<sub>p</sub> range by reducing the materials costs and improving throughput and yields.

### **2.3 Thin Film Solar Cells**

Another strategy for producing cells, and one that could lead to module costs much lower than for crystalline cells, uses thin (1-10 microns) films of materials, such as amorphous (glassy) silicon (a-Si), copper indium diselenide (CuInSe<sub>2</sub>, generally represented by CIS) and cadmium telluride (CdTe) instead of crystalline material [29-35]. Deposition of thin films, whose methods include (i) vacuum evaporation, (ii) electrodeposition, (iii) spraying, (iv) sputtering, (v) chemical vapour deposition, (vi) chemical dipping and (vii) glow-discharge, can be much more rapid, much less energy intensive, and done on a larger scale than the manufacture of thick crystalline silicon. In addition, thin films require less handling to assemble into workable units because they are formed into modules (large area devices) rather than individual cells. The process of making thin film modules consists of several steps: (i) the acquisition or manufacture of the substrate; (ii) cleaning and handling the substrate; (iii) deposition of an electrical contact; (iv) deposition of the active semiconductor layer; (v) deposition of another electrical contact; (vi) monolithic integration (scribing); (vii) encapsulation and (viii) sundry procedures such as cleaning and handling. In summary, there are two primary reasons for believing that thin films can eventually achieve lower costs than crystalline devices. First, materials used for thin films can be many times more efficient at absorbing sunlight than those used for thick wafers. As a consequence, far less PV material is needed, which greatly reduces costs. Secondly, the techniques used to produce thin films are particularly well suited for mass-production. The expensive batch processes of single-crystal production can be replaced by a continuous process in

which active materials are deposited directly onto a substrate. The central challenge here is to develop cells with acceptable efficiencies and to assure the stability and the reproducibility of the products. Here some of major technological processes for producing thin film solar cells are reviewed.

### **2.3.1 Amorphous Silicon (a-Si) Cells**

To date, alloys of amorphous silicon have received the most attention [36-43]. Amorphous silicon has the advantage of using a plentiful, benign material. Amorphous silicon differs from crystalline silicon in that the silicon atoms are not located at very precise distances from each other and the angles between the Si-Si bonds do not have a unique value. This randomness in the atomic arrangement has a powerful impact on the electronic properties of the material. It becomes a direct gap material with an optical energy gap of 1.75 eV, and its band structure shows a very high density of states within the energy gap, caused largely by incomplete bonding. It was found in 1969 that the incorporation of hydrogen in amorphous silicon could passivate the incomplete bonds and reduce the density of states in the band gap to such an extent that it became possible to make the material n-type or p-type by the incorporation of phosphorus or boron. Once it became possible to make p-n junctions in a-Si, its high absorption coefficient and ease of manufacture made it an attractive material for solar cells. Efficient a-Si solar cells consist of a thin film of the order of 1-10  $\mu\text{m}$  thick whereas a typical classical cell thickness is 100-400  $\mu\text{m}$ . This is because the absorption coefficient in this disordered material structure is one order of magnitude larger than in crystalline silicon. Moreover, the growth temperature for an amorphous material thin film is much lower (200-400°C) than for the crystalline technological process (about 1000°C).

Both p and n materials based on amorphous silicon have poor transport properties, therefore simple p-n junction cells had low efficiencies. The intrinsic a-Si has much better transport properties, thus the development of p-i-n junction cells led to rapid improvement in performance. Having determined the optimum structure, the

manufacturing process sequence can be defined. Starting with glass as a low cost transparent, weather-proof substrate, a layer of highly conductive optically transparent thin Si oxide is deposited, then a highly doped p-layer of a-Si, then the undoped intrinsic layer of a-Si, then a thin conductive n-layer of a-Si, and finally a metallic contact layer (Figure 2.6). Most of these cells operate with average efficiencies of 3.3 to 4.2 %.

As the quality of the a-Si material improved, it became apparent that the action of light absorption by the i-layer created additional defects, increasing the density of trapping and scattering states and reducing the efficiency of the cells. This effect - named the Staebler-Wronski effect after its discoverers - is dependent on the total number of photons absorbed. Therefore it depends on the intensity of light to which the cell is exposed, the duration of the exposure and the thickness of the i-layer. Exposure to room lighting, as is the case with solar calculators, has only a small effect, but bright sunlight reduces the efficiency considerably over time scales of months. This instability has serious consequences for the commercial viability of a-Si as a power producer and now it seems unlikely that the single junction a-Si will be used in such applications. Since the Staebler-Wronski effect depends on the thickness of the i-layer, it can be alleviated by using multiple junction structures, in which the absorption of light is split equally between 2 or 3 separate i-layers (Figure 2.7). Multijunction cells also enable access to more of the total energy. The light which is not absorbed by upper layers is captured by deeper layers. Typically the cells are designed so that each layer is sensitive to a different colour of incident light. The layers can be made by using different alloys of silicon or they can be made by combining silicon cells with cells made from other materials. Cells with such structure have been produced commercially and found to be significantly more stable than the single junction device. Experimental multijunction a-Si cells have demonstrated stabilised efficiencies of 10% (with initial efficiencies of 13.7%). It is not yet clear whether the stability is sufficient to allow these cells to be commercially viable as power generators.

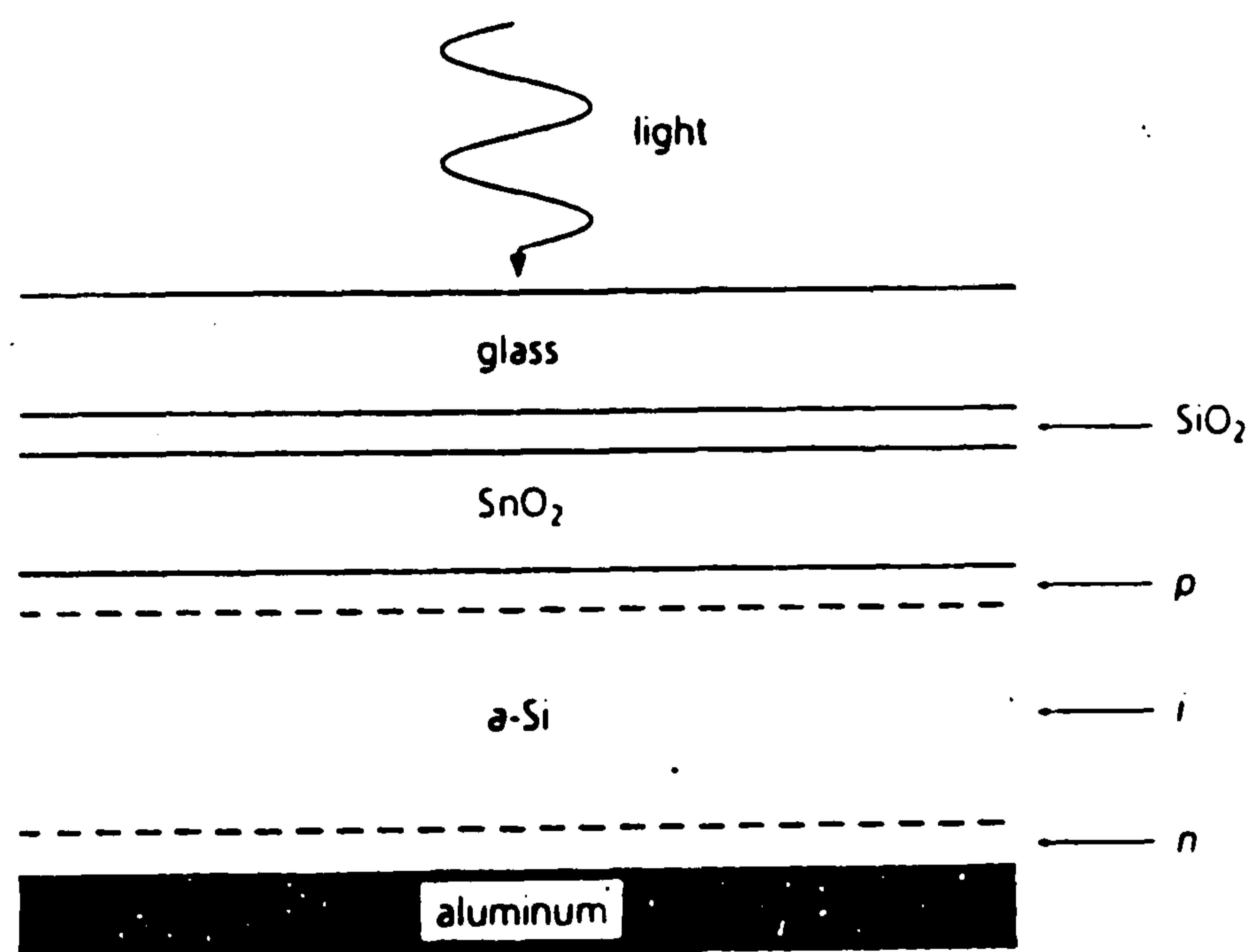

Figure 2.6: The device structure of a-Si cell, from source [36].

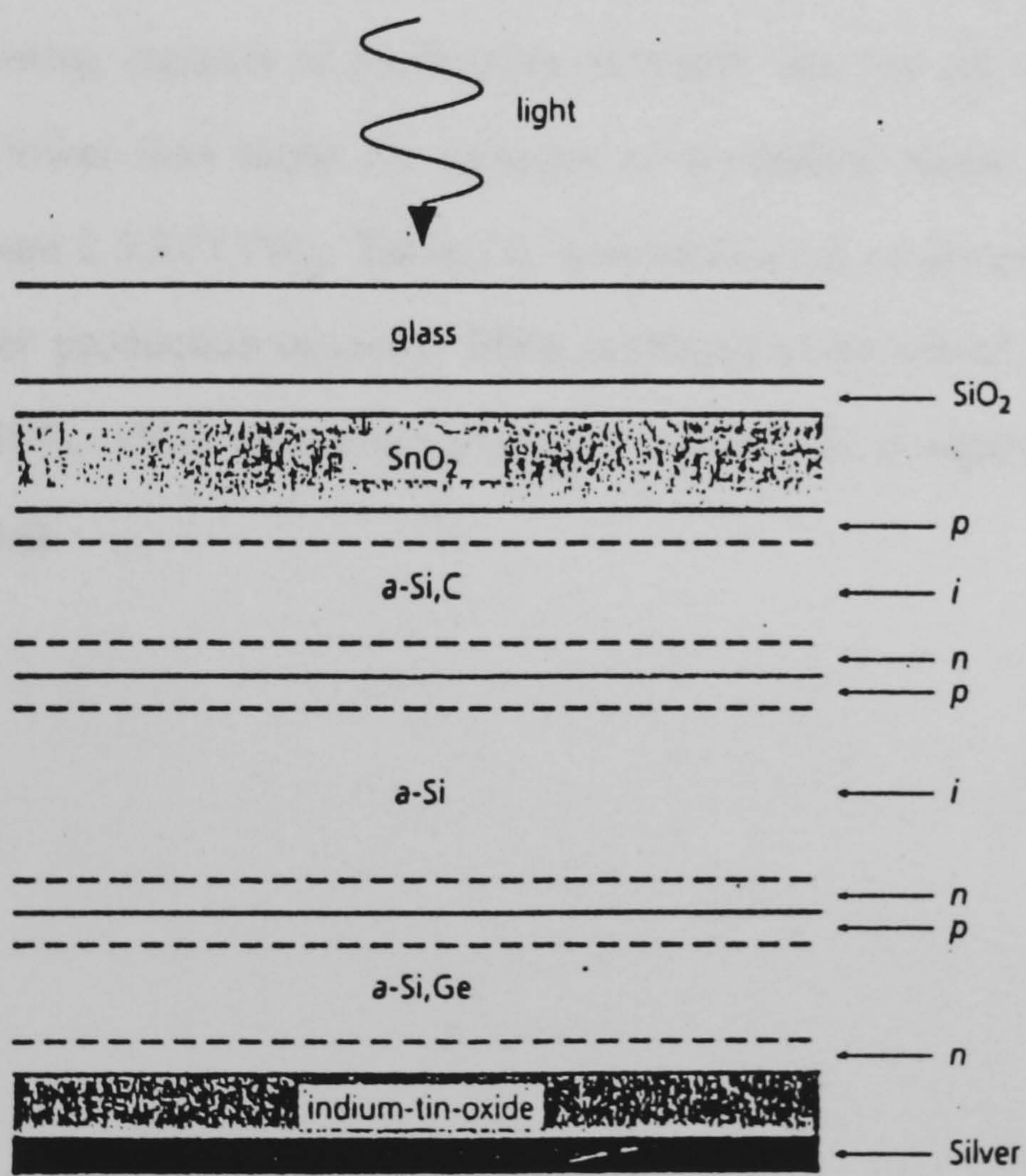

Figure 2.7: Schematic diagram of an a-Si multijunction cell, from source [36].

Amorphous silicon module production presently amounts to 21% of the global photovoltaic module production of 62 MW per year [28]. The following manufacturers supply modules at lower ratings above 5  $W_p$ : Neste Advanced Power Systems (NAPS), from France, Sanyo, from Japan, Advanced Photovoltaic Systems (APS), from USA, United Solar Systems Corp. (USSC), from USA, Phototronics, from Germany, and Siemens Solar also from Germany. Table 2.2 summarises the most recently achieved module efficiencies and indicates the stabilised values. Minimum degradation amounts to 13% of the initial value until stabilised values are achieved. High conversion efficiency at low cost has been defined as a primary goal of a-Si technology. The existing capacity of production, however, has not yet led to module costs considerably lower than those for modules of crystalline silicon. The present costs at NAPS amount 2.5 ECU/ $W_p$ . Table 2.3 summarises the projected a-Si module costs at much higher production capacity. Main problems to be solved are stabilised efficiencies above 10%, which represents a tough condition for competitiveness with other thin film options.



Table 2.2: a-Si module efficiencies, from source [29].

Manufacturer	Module Size	Module Efficiency
NAPS	30X90 cm <sup>2</sup>	5% stab.
PST	60X100 cm <sup>2</sup>	5.8% stab.
SANYO [37]	10X10 cm <sup>2</sup>	12%
SIEMENS SOLAR[38]	4000 cm <sup>2</sup>	9.6%
		7.5% stab.
	930 cm <sup>2</sup>	10.7%
		8.4% stab.
USSC	930 cm <sup>2</sup>	10.2% stab.

Table 2.3: Projected costs of a-Si modules, from source [29].

Source	Production Capacity	Material (ECU/W <sub>p</sub> )	Production Depreciation (ECU/W <sub>p</sub> )	Module Costs (ECU/W <sub>p</sub> )
Carlson and Wagner [39]	100000 m <sup>2</sup> /a	0.38	0.17	0.55
Mertens [40] (2000)		0.25	0.65	0.90
Wrixon [41] (2000) η=10%				1.0
New Sunshine Programme η=10%	100 MW/a			1.35
(2020)	500 - 1000 MW/a			0.5 - 0.75

### **2.3.2 Thin Film Polycrystalline Silicon Cells**

Complete optical absorptions in crystalline semiconducting materials require thicknesses of a few hundreds of microns [44-52]. The challenge in using thin films of polycrystalline silicon materials is how can the complete absorption be achieved. Optical path lengths of hundreds of microns can be maintained with silicon layers of tens of microns thick using the techniques of light trapping. Light incident on a flat planar cell will enter through an anti-reflection coating and an exponentially decreasing proportion will travel through the cell, to the back contact. Some light incident on the back contact will be reflected back through the cell for a second pass in which it will be either absorbed or leave the cell via the anti reflection coating. If the top and back surfaces are textured, rather than being flat, the light entering through the anti reflection coating will be refracted off-normal, and light reaching the back will be scattered, as will light reaching the top surface after reflection from the back. In this way, the optical path length of a typical light ray normally incident on the cell can be up to 20 times the cell thickness. Complete optical absorption can then be assured even for cell thicknesses of only a few tens of microns.

There are other benefits in using thin films of silicon materials for manufacturing solar cells. The diffusion length need be only 50-80 micron, so lower quality material can be used, and higher doping levels can be tolerated, giving higher circuit voltages. Because the optical absorption, and hence the photo generation is taking place within or close to the junction depletion region, carrier collection efficiencies are high, giving high short circuit currents. The reduced constraints on material quality mean that film deposition of silicon layers on low cost substrates can be considered without sacrificing much in the performance of the cells. This is therefore a very promising route for the production of efficient cells at low cost.

In order to implement this concept, one needs a low cost substrate which has a good thermal expansion to match to silicon, to avoid strain in the silicon film after

processing and one needs a silicon deposition process which gives high yield of suitable materials and potentially high throughput at acceptable capital cost. The growth of silicon films from saturated solutions of silicon in molten tin by liquid phase epitaxy has been found to meet the requirements for a commercial production process. The films as-grown have a columnar polycrystalline structure and post-processing is needed to increase crystallite size and passivate the grain boundaries. After this treatment, the p-type silicon film is processed by conventional diffusion techniques to give a n-p junction, then anti reflection coated and top connected in the usual way. The light trapping arises from the topology of the substrate surface, and the optical properties of the back contact metallisation. Efficiencies up to 16% have been observed in small area cells and about 12% in commercial 10cmX10cm cells. Improved cells based on this concept can be an important route to the US\$1/W<sub>p</sub> module.

### **2.3.3 Copper Indium Diselenide (CIS) Cells**

Copper indium diselenide is a semiconducting material which can be either n- or p type and has a direct optical absorption with the highest absorption coefficient measured to date [29, 53-58]. It is possible to make p-n homojunctions of CIS, but these are neither stable nor efficient, and the best devices to date are heterojunctions with cadmium sulphide (CdS). There is a quite good match between the lattice constants and electron affinities of CIS and CdS so that the recombination at the interface is not excessive. CdS can only be grown as n-type material, so the CIS must be p-type. The main improvements of efficiencies have been realised by increasing the bandgap of pure CuInSe<sub>2</sub> (E<sub>g</sub>=1eV) by the use of alloys with CuGaSe<sub>2</sub> and CuInS<sub>2</sub>. The basic structure of a Cu(In,Ga)(Se,S)<sub>2</sub> cell is shown in Figure 2.8. Table 2.4 summarises the highest efficiencies of Cu(In,Ga)(Se,S)<sub>2</sub> cells reported in the recent years.

Figure 2.8: Basic structure of a  $\text{Cu(In,Ga)(Se,S)}_2$  cell, from source [29].

Table 2.4: Summary of the highest efficiencies of  $\text{Cu(In,Ga)(Se,S)}_2$  cells reported in the recent years, from source [29].

Cell Type	$E_g$ (eV)	$V_{oc}$ (mV)	$j_{sc}$ (mA/cm <sup>2</sup> )	ff (%)	$\eta$ (%)	Laboratory
$\text{MgF}_2/\text{ZnO}/\text{CdS}/\text{CuInSe}_2$	1.02	519	41.2	75	16.1	RIT/MI/IPE
$\text{MgF}_2/\text{ZnO}/\text{CdS}/\text{Cu(In,Ga)Se}_2$	1.17	641	35.8	73	16.9	RIT/MI/IPE [53]
$\text{MgF}_2/\text{ZnO}/\text{CdS}/\text{Cu(In,Ga)Se}_2$		660	31.5	79	16.4	NREL
$\text{ZnO}/\text{CdS}/\text{Cu(In,Ga)(S,Se)}_2$	grad.	558	41.0	71	16.2	SIEMENS
$\text{MgF}_2/\text{ZnO}/\text{CdS}/\text{CuIn(S,Se)}_2$	1.12	613	33.5	74	15.2	IPE
$\text{ZnO}/\text{CdS}/\text{CuInS}_2$	1.45	715	23.7	71	12.0	IPE
$\text{ZnO}/(\text{Zn,Cd)S}/\text{CuGaSe}_2$	1.70	756	13.7	60	6.2	IPE

Large-scale module production is still in a pre commercial phase. Some production lines are under construction, however, no modules commercially produced are available. Projected costs of  $\text{Cu(In,Ga)(Se,S)}_2$  modules have been estimated [29] and are listed in table 2.5.

Table 2.5: Projected costs of  $\text{Cu(In,Ga)(Se,S)}_2$  modules, from source [29].

Source	Production Capacity	Material (ECU/W <sub>p</sub> )	Production Depreciation (ECU/W <sub>p</sub> )	Module Costs (ECU/W <sub>p</sub> )
Zweibel ( $\eta=10\%$ )	10 MW/a	0.1-0.3	0.5-1.4	0.6-1.7
( $\eta=15\%$ )	500 MW/a	0.08	0.2	0.28
Kapur [54] ( $\eta=15\%$ )		0.33	0.22	0.55
Siemens [55] ( $\eta=10-12\%$ )	10-30 MW/a	0.17	0.68	0.85
Wrixon [41] 2000 ( $\eta=15\%$ )				1.0

A CuInSe<sub>2</sub> module made by Siemens Solar has been operated for more than four years without any sign of degradation [29]. The highest efficiency of a CuInSe<sub>2</sub> module made by Siemens Solar with an area of 3832 cm<sup>2</sup> has achieved 11.2% [29]. There are however some problems in obtaining high yields in production, and commercialisation of the technology is being delayed until these problems are solved.

#### **2.3.4 Cadmium Telluride Cells**

It has been known since the 1950's that cadmium telluride has the ideal band gap for a solar absorber material and the research on these cells can be traced back to that time. These efforts however were small and uncoordinated and severely hampered by the low level of materials technology for the II/VI materials. As the II/VI materials technologies improved over the years, it became clear that cadmium telluride performance was limited by a high level of defects states close to the middle of the bandgap, forming very efficient recombination sites. The achievement of the late 1970's was to develop post-deposition treatments which greatly reduced the density of these recombination states, and the achievement of the 1980's has been to capitalise on this earlier work to develop efficient cells and efficient stable modules. There are a number of low cost techniques which can be used to deposit cadmium telluride such as chemical deposition, spraying and electrodeposition, and they can all, after a post-deposition treatment, yield high quality material and efficient cells [29, 59-65]. Figure 2.9 shows the structure of a CdTe-CdS solar cell.

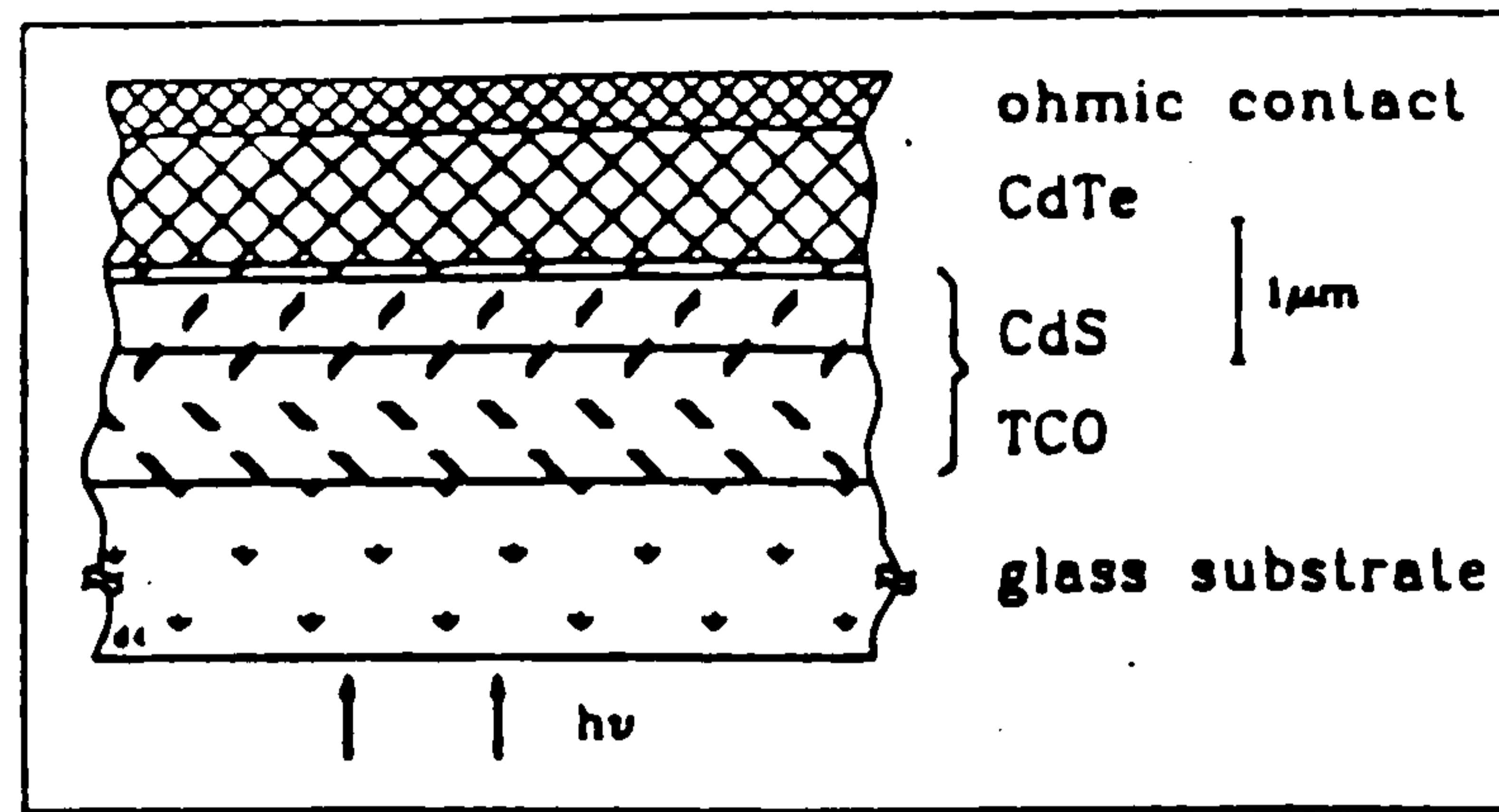

Figure 2.9: The structure of the CdTe-CdS solar cell, from source [29].

Cell efficiencies of 15.8% have been reported by T. C. Chu and by C. Ferekides [29] which prove the efficiency in economy, especially in view of the simple basic structure. Efforts to further improve the cells are undertaken by (i) annealing with  $O_2$  to improve p-type conduction of CdTe leading to more stable I-V characteristics, (ii) diffusion of Cu into CdTe to reduce the series resistance which presents a major problem in the performance, (iii) annealing of CdS with hydrogen to reduce the series resistance.

Commercial production with a capacity of about 1 MW/a is undertaken by Matsushita Battery. Plants for CdTe-module production are presently under construction at Golden Photon Inc. (GPI), Solar Cells Inc. (SCI) and BP Solar. Module efficiencies obtained by different commercial producers are listed in table 2.6. The values presented there indicate the maturity and high potential for large-scale production. Estimates of the prospective costs for CdTe module production are indicated in table 2.7.

Table 2.6: Module efficiencies of CdTe cells, from source [29].

<b>Manufacturer</b>	<b>Area (cm<sup>2</sup>)</b>	<b>Power (W)</b>	<b>Efficiency (%)</b>
Solar Cells Inc.	6879	53.1	7.7
Golden Photon	3528	27.5	7.7
Matsushita Batt.	1200	10.0	8.7
BP Solar	4540	35.6	7.8
	706	7.1	10.1

Table 2.7: Estimates of prospective costs for CdTe module production, from source [29].

<b>Source</b>	<b>Production Capacity</b>	<b>Material (ECU/W<sub>p</sub>)</b>	<b>Production Depreciation (ECU/W<sub>p</sub>)</b>	<b>Module Costs (ECU/W<sub>p</sub>)</b>
Bonnet [59]	10 MW/a	0.6	0.9	1.5
Wrixon [41] (2000) $\eta=15\%$				1.0
Zweibel $\eta=15\%$	500 MW/a	0.12	0.16	0.28



Present production capacities below 10 MW/a yield costs in the order of 1-1.5 ECU/W<sub>p</sub>, whereas at 500 MW/a production costs as low as 0.28 ECU/W<sub>p</sub> would result [29]. Under these conditions competitiveness with conventional electrical power production can be achieved.

#### **2.4 Concentrator Solar Cells**

Photovoltaic concentrators, as the name implies, use a lens or mirror to collect sunlight and then recast the concentrated light onto a solar cell of smaller size (see Figure 2.10). The advantage of this approach is that it circumvents the need for developing large areas of low-cost solar cells by replacing them with low-cost concentrators [66-72]. Thus, a major emphasis in the development of PV concentrators is the design and development of high efficiency concentrator cells. A wide range of designs has been developed, including some using Fresnel lenses. The amount of solar concentration has varied from a factor of 2 to a factor of 1000. Currently, most concentrators use silicon cells. Gallium arsenide (GaAs) cells and multijunction devices are also being investigated by several groups. Concentrator cells of silicon are reported as having achieved efficiencies in excess of 26% [66]. Gallium arsenide cells achieved 28% and multijunction cells 34% [66]. An important factor to consider in manufacturing concentrator cells is that they have to be able to withstand very high temperatures and very high levels of illumination without compromising much the efficiency and without much light-induced degradation (Stable-Wronski effect). The temperature of concentrator cells is normally maintained near ambient by active or passive cooling. The concentration ratio  $X$  of a perfectly focused system is the ratio of the concentrator input aperture to the surface area of the cell [67]. Low  $X$  systems ( $X \leq 5$ ) do not have to be oriented through the day to follow the sun and so make use of some diffuse as well as direct insolation [67]. Increased  $X$  systems have to track the sun, and are only sensible in places with a large proportion (>70%) of direct radiation [67].

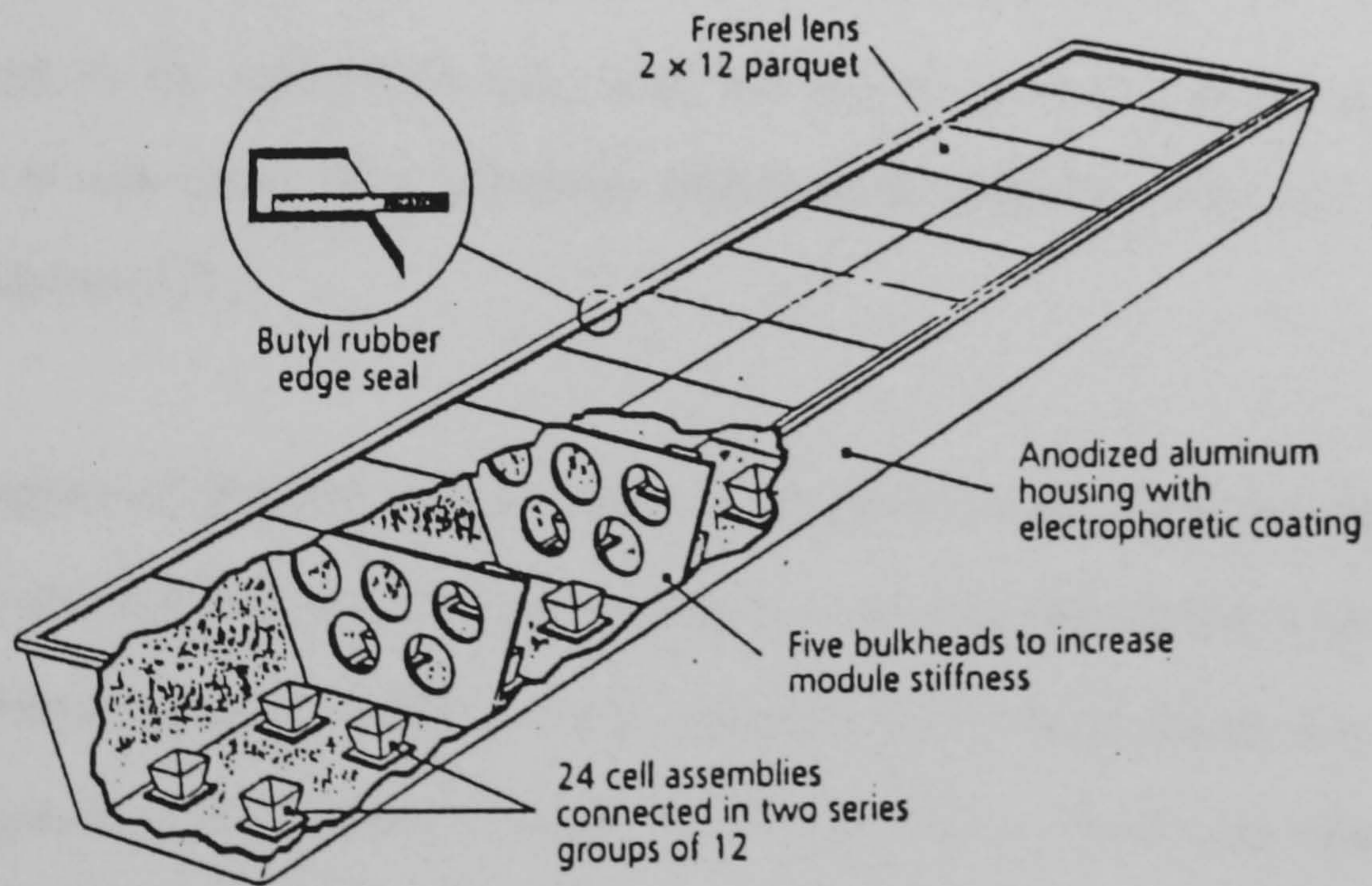
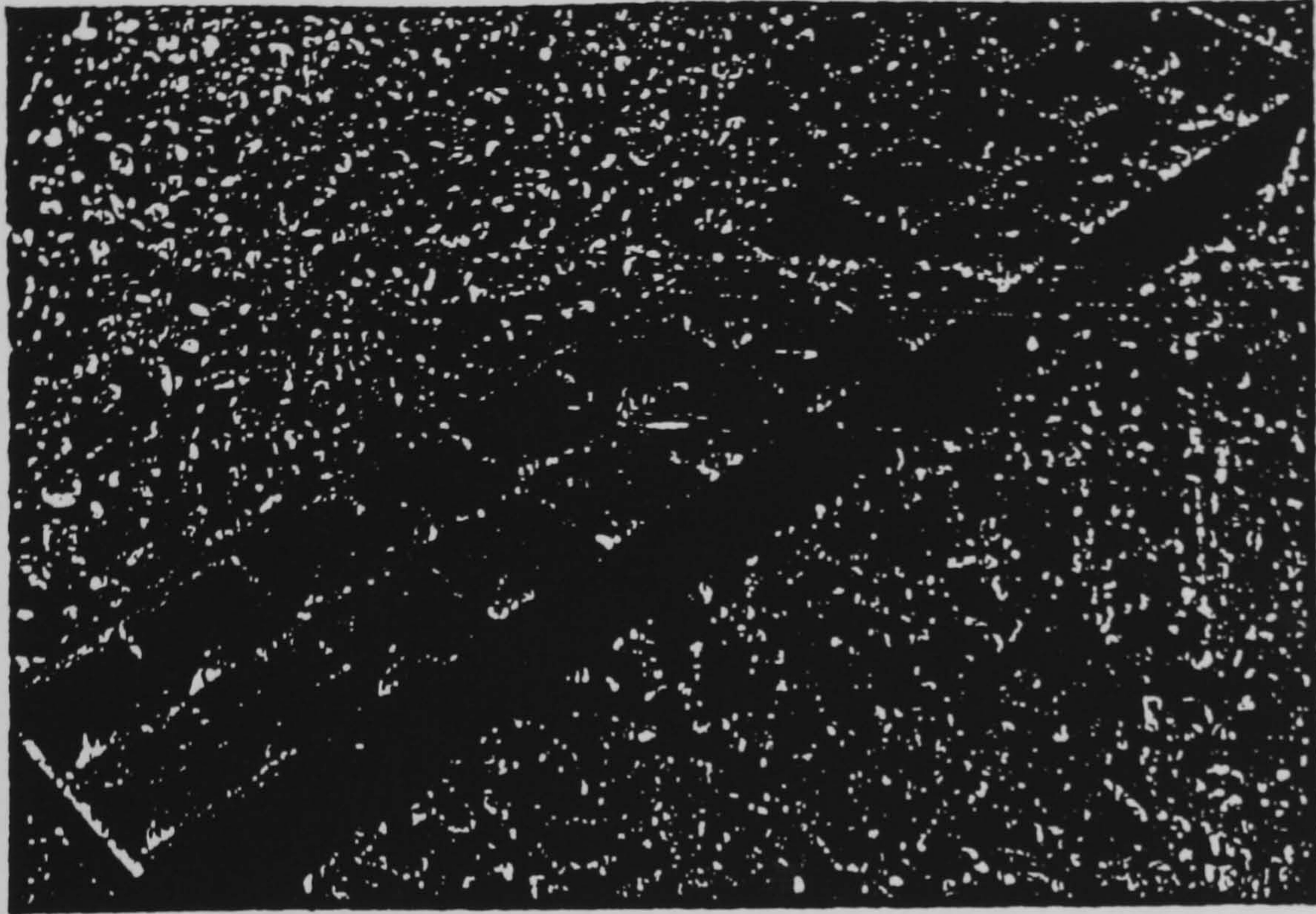

Figure 2.10: Photograph and drawing of the Sandia design point focus concentrator module, from source [66].

## **2.5 PV Modules**

Solar cells are fragile objects which must be mechanically supported and shielded from any possible corrosion. Therefore the whole module structure is mounted in an environmentally protective package [28, 73-75]. The outer surface of the module is usually low-iron tempered glass. Glass is used because it is the cheapest transparent weather-proof material available. Low iron content is specified to enhance the transparency of the glass, whilst tempered glass is specified for its mechanical properties, particularly impact resistance. The back protection for the cells can be glass, metal or plastic. Glass is used when maximum resistance to corrosion is demanded, but the most common back protection is metal/plastic foil, usually Tedlar/Aluminum/Tedlar. This combines low cost, lightness, good environmental protection and good thermal conductivity to ensure that cell temperatures do not rise too high during operation.

The most vulnerable point on a PV module is the electrical connections. Therefore, such connections are normally fed into a weather-proof connection box. A diode is often included in the connection box, with the aim to prevent battery discharging during night or non-sunny days. Modules with built-in inverters, called AC modules, are in development [75 ].

The encapsulation of thin film cells is clearly different from that of silicon wafers. It is usual to manufacture thin film cells as integrally interconnected modules (see Figure 2.11). The glass outer cover is thus already in place and the encapsulation is concerned to protect the back of the module, to prevent moisture ingress around the sides and to protect the electrical connection wires. Modules for amorphous silicon cells can often be very simple as they are used in products which are not expected to last more than few years and may not be left outdoors all the time. For power modules, the encapsulation is adapted from that of silicon wafers. The encapsulation of polycrystalline films has proved more difficult than for amorphous silicon, since such

films absorb water vapour much more readily [28]. Special protection measures, including the incorporation of desiccants, are necessary.

In thin film technology, the production of integrally interconnected modules, rather than cells, brings both benefits and problems. The major benefit is the large cost saving of producing a fully working module and avoiding the cost of manually or automatically stringing the cells together. The problem can arise from the non-uniform performance of different areas of the module, which causes the mis-match.

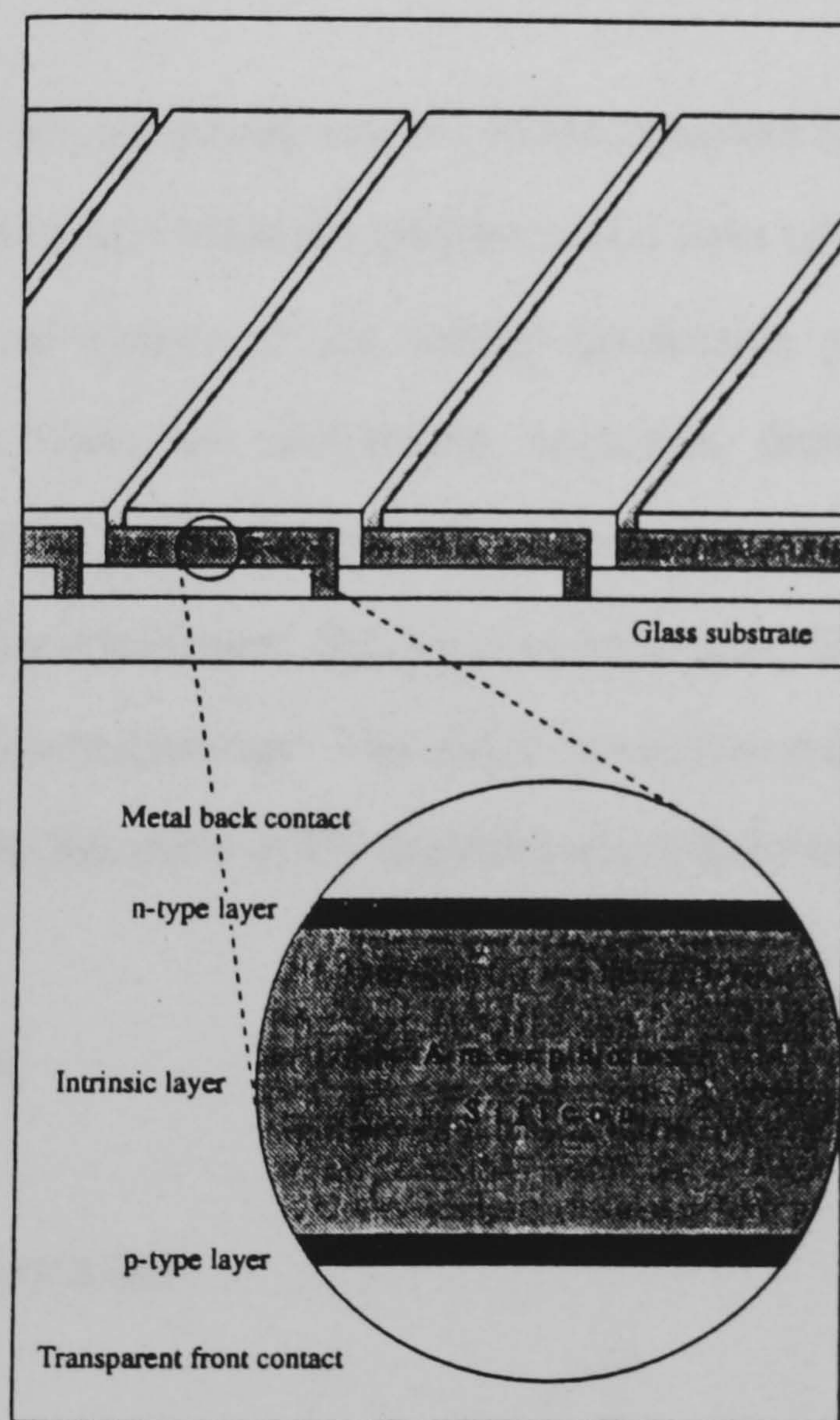

Figure 2.11: Integrally interconnected module, from source [28].

## **2.6 Environmental Risks of Solar Cells Technologies**

Energy technologies and their associated fuel cycles produce environmental burdens such as acid deposition, and these burdens result in environmental impacts, e. g. forest damage, which in its turn impose considerable costs to society [76-81]. Photovoltaic energy conversion is increasingly regarded as a technology which may contribute to the world energy supply in a way that is compatible with the concept of sustainable development. However, to ensure that PV can indeed fulfil this expectation, a careful consideration of potential environmental risks of PV energy conversion is necessary.

As in any other technology, a detailed analysis of the complete fuel cycle of the specific technology is important to determine the environmental risks of photovoltaics. Such an analysis should cover all stages of the energy production process, including fuel extraction, preparation, transport, conversion, operation, distribution, utilisation, as well as waste processing and disposal. This procedure is generally known as Environmental Life Cycle Assessment (LCA) of technologies. This methodology has to be implemented for each technology. The major environmental impacts identified as being associated with the life cycle of PV modules are as follows:

- . Atmospheric pollution;
- . Water pollution;
- . Impacts on natural ecosystems;
- . Accidents;
- . Land use;
- . Visual intrusion;
- . Resource depletion;
- . Noise;
- . Public and occupational health impacts.

Atmospheric pollution is mainly associated with the refining of the raw materials due to the use of energy from a mix of conventional power sources. A value of 0.3 kg CO<sub>2</sub>/kWh(t) is the usual assumption. Diesel-fuelled lorries will contribute to atmospheric pollution due to the emission of NO<sub>x</sub>, CO, HC and particulates. Leakage of waste products and effluents into the local water system could cause contamination of the ground and drinking water. This would have an impact on the natural aquatic ecosystem and could be distributed through the local food chain. Accidents occur during the mining process as well as during transportation of the raw materials to the refining plant. Industrial accidents also occur in the plant. Land use and visual intrusion are dependent upon the type of mining technology employed for the various materials. It is obvious that extraction of any naturally occurring material, without recycling, will eventually deplete its resources. Noise caused by the transport of raw materials has to be acknowledged as a minor environmental impact. Public and occupational health impacts are dependent upon the material mined, the techniques used, the chemical wastes at manufacture and the compliance with the existing health and safety regulations.

## **2.7. Conclusions**

Today crystalline silicon is the dominant industrial photovoltaic technology and is very likely to remain in that position for the next 10 years. In recent years a revival of single crystalline silicon is clearly noticed [22,28] and it is unclear whether single- or polycrystalline silicon will take the largest market share in the future. The cost goal of US\$2/W<sub>p</sub>, necessary for PV to be competitive with conventional energy supply systems remains a realistic objective which can be reached by a combination of factors, such as thinner wafers, higher efficiencies and the use of simpler processes designed for manufacturability.

The four types of thin film cells here discussed are not the only devices being studied, but they are the ones in or near commercial production. In recent years interest in thin

films based on crystalline silicon (x-Si), copper-indium-diselenide, cadmium telluride and other materials has been growing. Neither the CIS nor the CdTe thin films are commercially available in large volumes, but they offer strong competition to a-Si because of their comparatively high stabilised efficiencies. These new thin-films probably will not require the vacuum processes needed for a-Si and may therefore be less expensive to manufacture. They do, however, require somewhat more expensive materials, some of which could present environmental problems, unless they are appropriately recycled. During the next few years there will be a competition between a-Si and the crystalline thin-film materials. Over the long term the most promising strategy may involve both technologies in multijunction devices. As compared with crystalline photovoltaic cells and modules, thin films photovoltaics provides promising outlooks. Not only quite reduced consumption of materials and energy for production present substantial advantages for economy and ecology, but also the direct integration into modules during the manufacturing process and the large production capacity marks clearly the potential of thin film technology for photovoltaics. Typical thicknesses are in the range of 1-10  $\mu\text{m}$ . Advanced deposition processes allow multiple layers to be deposited. Hereby an optimisation in respect with the structural, optical and electronic properties of the different materials can be achieved. These optimisation processes lead to high values of efficiencies which are comparable to crystalline PV cells. All these types of thin film cells have the potential for large scale production at low unit cost, and it is not clear at the present moment which of these types will ultimately prove to be superior. It will very likely be that each of these types of cells, along with wafer silicon cells and concentrators, will have superior advantages in some applications, and they will therefore find a place in the future PV markets.

The environmental issue of cells fabrication is of growing importance. Solutions such as reprocessing of chemicals or extraction of metals from waste water have to be considered, in order to improve the safety and reduce the health risks associated with the use of PV technology.



## References

- [1] UNESCO, "Photovoltaics for Rural Electrification", June 1988.
- [2] P. Vanderhulst, H. Lanser, P. Bergmeyer, F. Foeth and R. Albers "Solar Energy: Small Scale Applications in Developing Countries", TOOL, 1990.
- [3] E. Terrado, M. Mendis and K. Fitzgerald "Impact of Lower Oil Prices on Renewable Energy Technologies", The World Bank Industry and Energy Department, 1988.
- [4] H. Kelly "Introduction to Photovoltaic Technology", in Renewable Energy: Sources for Fuel and Electricity, Edited by Thomas B. Johansson et al., Earthscan Publications Ltd., London, 1993, Pages 297-336.
- [5] P. Maycock "Photovoltaic Technology Performance, Cost and Market Forecast to 2010", PV Energy Systems, Inc. P. O. Box 290, Casanova, Virginia, 1991.
- [6] A. Eyer, A. Raubner and A. Goetzberger "Silicon Sheet Materials for Solar Cells", Optoelectronics, Volume 5, Pages 239-257.
- [7] N. B. Mason and D. Jordan "A High Efficiency Silicon Solar Cell Production Technology", Proceedings of the 10th EC PVSEC, Lisbon, Portugal, April 1991, Pages 280-283.
- [8] D. Shugar "Photovoltaics in the Utility Distribution System : The Evaluation of System and Distributed Benefits", Proceedings of the 21st IEEE PVSC, Orlando, May 1990, Pages 836-843.

- [9] H. Herzer "The Development of the Wafer Cost and Availability for the Photovoltaic Industry", Proceedings of the 10th EC PVSEC, Lisbon, Portugal, April 1991, Pages 501-506.
- [10] J. E. Bigger, E. C. Kern and M. C. Russel "Cost Effective Photovoltaic Applications for Electric Utilities", Proceedings of the 22nd IEEE PVSC, Las Vegas, Nevada, October 1991.
- [11] G. E. McGuire (Editor) "Semiconductor Materials and process technology Handbook", Noyes, Park Ridge, Illinois, 1988.
- [12] M. A. Green "Solar Cells: Operating Principles, Technology and System Applications", Prentice-Hall, New Jersey, 1982.
- [13] Allan L. Fahrenbruch and Richard H. Bube "Fundamentals of Solar Cells: Photovoltaic Solar Energy Conversion", Academic Press Inc., 1993.
- [14] R. J. Van Overstraeten and R. P. Mertens "Physics, Technology and Use of Photovoltaics", Adam Hilger, 1986.
- [15] R. Hill (Editor) "Applications of Photovoltaics", Adam Hilger, 1989.
- [16] S. M. Sze "Physics of Semiconductor Devices", 2nd Edition, Wiley, New York, 1981.
- [17] J. Fricke and W. L. Borst "Energie, Lehrbuch der Physikalischen Grundlagen", Oldenbourg-Verlag, München, 1981.

- [18] A. B. Meinel and M. P. Meinel "Applied Solar Energy", Adison Publishing Company 1977.
- [19] A. Luque "Review on High Efficiency Silicon Solar Cells", Proceedings of the 10th EC PVSEC, Lisbon, Portugal, April, 1991, Pages 233-239.
- [20] A. Luque "Solar Cells and Optics for Photovoltaic Concentration", Adam Hilger, Bristol, 1989.
- [21] A. Luque and G. L. Araújo (Editors) " Physical Limitations to Photovoltaic Energy Conversion", Adam Hilger, Bristol, 1990.
- [22] R. Mertens "Silicon Solar Cells", Proceedings of the 12th EC PVSEC, Amsterdam, The Netherlands, April 1994, Pages 1-6.
- [23] F. Lasnier and T. G. Ang "Photovoltaic Engineering Handbook", Adam Hilger, 1990.
- [24] M. A. Green "Crystalline and Polycrystalline Silicon Solar Cells", in Renewable Energy, Sources for Fuel and Electricity, Edited by Thomas B. Johansson et al., Earthscan Publications Ltd., London, 1993, Pages 337-360.
- [25] M. A. Green, S. R. Wenham and J. Zhao "High Efficiency Silicon Solar Cells", 11th EC PVSEC, Montreux, Switzerland, October 1992, Pages 41-44.
- [26] R. Swanson, P. Verlinden, R. Crane, R. Sinton and C. Tilford "High Efficiency Silicon Solar Cells", 11th EC PVSEC, Montreux, Switzerland, October 1992, Pages 35-40.

- [27] P. J. Verlinden, R. A. Crane, R. M. Swanson, T. Iwata, K. Handa, H. Ogasa and D. L. King "A 21.6% Efficient Photovoltaic Module with Backside Contact Silicon Solar Cells", 12th EC PVSEC, Amsterdam, The Netherlands, April 1994, Pages 1304-1307.
- [28] Robert Hill, Phil O'Keefe and Colin Snape "The Future of Energy Use", Earthscan Publications Ltd., London, 1995.
- [29] W. H. Bloss "Thin Film Solar Cells - State of the Art and Future Trends", Proceedings of the 12th EC PVSEC, Amsterdam, The Netherlands, April 1994, Pages 37-43.
- [30] Tadashi Saitoh, Ryuichi Shimokawa and Yutaka Hayashi "Recent Progress in Research and Development of Crystalline Silicon Solar Cells", Progress in Photovoltaics: Research and Applications, Volume 1, 1993 Pages 11-23.
- [31] V. K. Kapur and B. Basol "Key Issues and Cost Estimates for the Fabrication of CIS PV Modules by the Two-stage Process", Proceedings of the 21st IEEE PVSC, 1990.
- [32] C. L. Kendall, J. C. Checchi, M. L. Rock, R. B. Hall and A. M. Barnett "10% Efficient Commercial-Scale Silicon-Film Solar Cells", Proceedings of the 20th IEEE PVSC, 1990.
- [33] J. Jordan and S. Albright "Large Area CdS/CdTe Solar Cells", Solar Cells, Volume 23(1-2), 1988, Pages 107-114.

- [34] T. W. F. Russell, B. N. Baron and R. E. Rocheleau "Economics of Processing Thin Film Solar Cells", *Journal of Vacuum Science and Technology*, Volume B2(4), 1984, Pages 840-844.
- [35] R. Noufi, R. C. Powel and R. J. Matson "Low Cost Methods for the Production of Semiconductor Films for CuInSe<sub>2</sub>/CdS Solar Cells", *Solar Cells*, Volume 21, 1987, Pages 55-63.
- [36] David E. Carlson and Sigurd Wagner "Amorphous Silicon Photovoltaic Systems", in *Renewable Energy, Sources for Fuel and Electricity*, edited by Thomas B. Johansson et al., Earthscan Publications Ltd., London 1993, Pages 403-435.
- [37] S. Tsuda, T. Takahama, Y. Hishikawa, H. Tarui, H. Nishiwaki, K. Wakisaka and S. Nakano, *Journal of Non-Crystal Solids*, Volumes 164-166, 1993, Pages 679-684.
- [38] J. Bauer, H. Calwer, P. Marklstorfer, P. Milla, F. W. Schulze and K.-D. Ufert, *Journal of Non-Crystal Solids* Volumes 164-166, 1993 Pages 685-688.
- [39] S. Wagner and D. E. Carlsson "Renewable Energy", Island Press, 1993.
- [40] R. Mertens, J. Nijs, R. Van Overstraeten and W. Palz "Summary of Panel Discussion: Technical Goals and Financial Means for PV Development", 11th EC PVSEC, Montreux, Switzerland, October 1992, Pages 18-22.
- [41] G. Wrixon et al. "Renewable Energy 2000", Springer, 1993.
- [42] D. E. Carlsson "Amorphous Thin Films for Terrestrial Solar Cells", *Journal of Vacuum Science and Technology*, Volume 20 (3), 1982, Pages 290-295.

- [43] E. Sabisky et al. "Eureka - A 10 MW<sub>p</sub> a-Si:H Module Processing Line", Proceedings of the 9th EC PVSEC, Freiburg, Germany, October 1989, Pages 1537-1544.
- [44] Ken Zweibel and Allen M. Barnett "Polycrystalline Thin-Film Photovoltaics", in Renewable Energy, Sources for Fuel and Electricity, edited by Thomas B. Johansson et al., Earthscan Publications Ltd., London 1993, Pages 437-481.
- [45] A. Eyer, A. Rauber and A. Goetzberger "Silicon Sheet materials for Solar Cells", Optoelectronics Volume 5, 1990, Pages 239-258.
- [46] D. A. Hukin "Polycrystalline Photovoltaic Silicon Ingot Production", Technical Digest 5th International Photovoltaic Science and Engineering Conference, Kyoto, November 1990, Pages 303-306.
- [47] H. Watanabe, K. Hirawasa, K. Masuri, K. Okada, M. Takayama, K. Fukui and H. Yamashita "Technical progress of Large Area Multicrystalline Silicon Solar Cells and Its Applications", Optoelectronics, Volume 5, 1990, Pages 223-238.
- [48] M. A. Green "High Efficiency Silicon Solar Cells", Trans Tech Publications, Aedermannsdorf, 1987.
- [49] M. B. Mason, D. Jordan and J. G. Summers " A High Efficiency Silicon Solar Cell Production Technology", Proceedings of the 10th EC PVSEC, Lisbon, Portugal, April 1991, Pages 280-283.
- [50] M. A. Green "Recent advances in Silicon Solar Cell performance", Proceedings of the 10th EC PVSEC, Lisbon, Portugal, April 1991, Pages 250-253.

- [51] M. A. Green, S. R. Wenham, J. Zhao, S. Bowden, A. M. Milne, M. Taouk and F. Zhang "Present Status of Buried Contact Solar Cells", Proceedings of the 22nd IEEE PVSC, Las Vegas, October 1991.
- [52] C. M. Chong, S. R. Wenham and M. A. Green "High Efficiency Laser Grooved, Buried Contact Solar Cell", Applied Physics Letters, Volume 52, Pages 107-109.
- [53] J. Hedström, 23rd IEEE PVSC, Louisville, 1993, Pages 364-371.
- [54] V. K. Kapur and B. M. Basol, 21st IEEE PVSC, Kissimee, 1991, Pages 467-470.
- [55] Siemens Solar, 23rd IEEE PVSC, Louisville, 1993.
- [56] R. Noufi, R. C. Powell, and R. J. Matson "Low Cost Methods for the Production of Semiconductor Films for CuInSe<sub>2</sub>/CdS Solar Cells", Solar Cells, Volume 21, 1987, Pages 55-63.
- [57] R. R. Potter, C. Eberspacher and L. B. Fabrick "Device Analysis of CuInSe<sub>2</sub>/(Cd,Zn)S/ZnO Solar Cells", Proceedings of the 18th IEEE PVSC, 1985, Pages 1659-1664.
- [58] W. S. Chen and R. A. Mickelsen "High Photocurrent Polycrystalline Thin Film CdS/CuInSe<sub>2</sub> Solar Cell, Applied Physics Letters Volume 36(5), 1980, Pages 371-373.
- [59] D. Bonnet, International Journal of Solar Energy, Volume 12, 1992.

- [60] T. L. Chu, S. Chu, J. Britt, G. Chen, C. Ferekides, N. Schultz, C. Wang and C. Q. Wu, "High Efficiency Thin Film Cadmium Telluride Solar Cells", Proceedings of the 11th EC PVSEC, Montreux, Switzerland, October 1992, Pages 988-990.
- [61] J. Britt and C. Ferekides "Recent Advances in CdTe Solar Cells by Close-Spaced Sublimation (CSS)", Proceedings of the 11th EC PVSEC, Montreux, Switzerland, October 1992, Pages 276-277.
- [62] Y. Tyan et al., 16th IEEE PVSC, 1982, Pages 928-.
- [63] A. Kampmann, P. Cowache, R. Ortega-Borges, D. Lincot and J. Vedel "Electrodeposition of Cadmium Telluride on Tin Oxide Substrates Covered by Chemically Deposited Cadmium Sulfide Layers", Proceedings of the 12th EC PVSEC, Amsterdam, The Netherlands, April 1994, Pages 664-667.
- [64] L. M. Peter and Y. Sugimoto " Electrochemical Nucleation and Growth of Cadmium Telluride", Proceedings of the 12th EC PVSEC, Amsterdam, The Netherlands, April 1994, Pages 668-671.
- [65] A. S. Reintjes, L. M. Peter, M. E. Özsan, S. Dennison and S. Webster "A New Mechanism for the Electrodeposition of Cadmium Telluride", Proceedings of the 12th EC PVSEC, Amsterdam, The Netherlands, April 1994, Pages 672-675.
- [66] Eldon C. Boes and Antonio Luque "Photovoltaic Concentrator Technology", in Renewable Energy, Sources for Fuel and Electricity, Edited by Thomas B. Johansson et al., Earthscan Publications Ltd., London, 1993, Pages 361-401.
- [67] J. W. Twidell and A. D. Weir "Renewable Energies Resources, E. and F. N. Spon, London, 1986.



- [68] J. Chamberlin "The Cost of Photovoltaic Concentrator Modules", Proceedings of the 20th IEEE PVSC, Las Vegas, Nevada, October, 1988.
- [69] A. Salim and N. Eugenio "A Comprehensive Report on the Performance of the Longest Operating 350 kW Concentrator Photovoltaic Power Systems", Solar Cells, Volume 29, 1990, Pages 1-24.
- [70] A. Luque and J. Minano "Optical Aspects in Photovoltaic Energy Conversion", Solar Cells, Volume 34, 1991, Pages 237-258.
- [71] M. Green, A. Blakers, S. Wenham, J. Zhao, C. Chong, M. Taouk, S. Narayanan and M. Wilson "Improvements in Flat-Plate and Concentrator Silicon Cell Efficiency", Proceedings of the 19th IEEE PVSC, May 1987.
- [72] C. Chiang and M. Quintana "Sandia's Concept - 90 Photovoltaic Concentrator Module", Proceedings of the 21st IEEE PVSC, Orlando, Florida, May 1990.
- [73] T. M. Bruton, R. D. W. Scott, J. P. Nagle, M. C. M. Man, A. D. Fackkerall "Recycling of High Value, High Energy Content Components of Silicon PV Modules", Proceedings of the 12th EC PVSEC, Amsterdam, The Netherlands, April 1994, Pages 303-304.
- [74] K. Bücher and G. Kleiss "The Need for an International Energy Rating Concept for Photovoltaic Modules", Proceedings of the 12th EC PVSEC, Amsterdam, The Netherlands, April 1994, Pages 299-302.
- [75] C. P. M. Dunselmann, T. C. J. van der Weiden, S. W. H. de Haan, F. ter Heide, R. J. C. van Zolingen "Feasibility and Development of PV Modules with Integrated

Inverter: AC-Modules", Proceedings of the 12th EC PVSEC, Amsterdam, The Netherlands, April 1994, Pages 313-315.

[76] A. Baumann, R. Ferguson, I. Fells and R. Hill "A Methodological Framework for Calculating the External Costs of Energy technologies", Proceedings of the 10th EC PVSEC, Lisbon, Portugal, April 1991, Pages 834-837.

[77] K. M. Hynes, N. M. Pearsall and R. Hill "Sensitivity Analysis of Energy Requirements for Thin Film Photovoltaic Module production", Proceedings of the 10th EC PVSEC, Lisbon, Portugal, April 1991, Pages 461-464.

[78] E. A. Alsema and B. C. W. Engelenburg "Environmental Risks of CdTe and CIS Solar Cell Modules", Proceedings of the 11th EC PVSEC, Montreux, Switzerland, October 1992, Pages 995-998.

[79] B. C. Van Engelenburg and E. A. Alsema "Environmental Risks of Amorphous Silicon Solar Cells", Proceedings of the 12th EC PVSEC, Amsterdam, The Netherlands, April 1994, Pages 305-308.

[80] K. M. Hynes, A. E. Baumann and R. Hill "Life Cycle Analysis of PV Modules Based on Cadmium Telluride", Proceedings of the 12th EC PVSEC, Amsterdam, The Netherlands, April 1994, Pages 309-312.

[81] M. T. Bhatti, K. H. Hynes, R. W. Miles and R. Hill "Thin Films of Cadmium Telluride Produced Using Stacked Elemental Layer (SEL) Processing for Use in Thin Film Solar Cells", International Journal of Solar Energy, Volume 12, 1992, Pages 171-182.

## **Chapter 3**

# **Monitoring of a Photovoltaic Water Pumping Plant**

### **3.1 Introduction**

A good understanding of the performance of the photovoltaic technology in local environmental conditions is a prerequisite for its optimal harnessing. In this chapter a study concerning the characterisation of the major components of a PV system operating in natural environmental conditions is presented. Due to the fact that lifting of water is an application in which PV can have a major social impact in Southern Africa, an experimental water pumping PV plant was installed for the investigation.

The plant used in this research comprises the following components: a PV array, with a capacity of 848  $W_p$ , an inverter and a motor-pump unit. A suitable monitoring unit has been integrated into the system. The basic processes in the system can be characterised as follows: sunlight is converted into DC power by means of the PV array; the inverter converts the DC power into AC; and finally the AC power is converted into hydraulic power by means of the motor-pump unit. The general characterisation of the plant (this means the determination of power losses or conversion efficiencies by major components or subsystems of the plant, namely the PV array, the inverter and the motor-pump unit) is the first aspect considered in this chapter.

The efficiency of a PV system is a function of both the incident light intensity and the load. Even if a fixed load is assumed, the variation of intensity on a normal day is such as to effect a considerable difference between the maximum possible efficiency of the system and its average operating efficiency. This difference in efficiencies is at least 17% [1]. When considered in conjunction with a randomly fluctuating load, this difference in efficiencies is significant. Consequently, it becomes desirable to have the system operating at the maximum possible efficiency for arbitrary conditions of illumination and load. In [1-6] a method aimed at reducing such losses is presented. As such losses occur in the match between the PV array and the remainder of the system, the method consists of integrating a power electronic interface (PEI) unit between the two subsystems. This unit has the following functions:

. To transform the DC varying voltage from the PV array to a constant and higher level voltage, by means of a DC-DC step-up converter and

. To keep the PV system working at its peak power point, in accordance with the current-voltage (I-V) characteristics of the PV array and of the load.

A power electronic interface unit was developed and tested by El Safi [3-4] for a small scale version PV system (20 W) having exhibited excellent stability and high efficiency for a wide range of input powers and loads. If the performance of the PEI unit in practice matches its simulated performance, it could give a useful improvement in the overall performance of the system, contributing, in this way, to reduce the costs of energy services provided by photovoltaics. Thus, a second aspect considered in this chapter concerning the characterisation of the plant referred was the investigation of the performance of such a device, which was integrated in the plant. In chapter 4 the effectiveness of that device is investigated using economic methods, due to the fact that it can happen that the device is technically effective but its cost offsets the technical advantages [3-4,7-8].

Estimates of long-term performance of photovoltaic systems are needed to design economically optimal systems. For this it is important to develop methods which describe accurately the performance of the PV array, which is the heart of a PV system. Recently, interest has developed in simplified design methods for PV arrays, instead of resorting to the very exact solid state physics theory models [9-11]. Therefore the testing of a simplified model describing the performance of the PV array of the plant was a third and last aspect considered in this chapter.

## 3.2 Theoretical Background

### 3.2.1 Determination of Efficiencies of Major PV Systems Components

The conversion efficiency of any device is given by the ratio between the power or energy coming out from the device in a time interval  $\Delta t$  and the power or energy coming into the device during the same time interval  $\Delta t$ . Mathematically this can be expressed as:

$$\eta = \frac{P_{out}}{P_{in}} = \frac{E_{out}}{E_{in}} \quad (3.1)$$

This concept can be used to determine the energy efficiencies or losses in any device, like the PV array, the inverter and the motor-pump unit for the case of the present research work.

From (3.1), the efficiency of a PV array can be expressed as:

$$\eta_{array} = \frac{P_{dc}}{A \cdot E_e} = \frac{I_{dc} \cdot V_{dc}}{A \cdot E_e}, \quad (3.1-a)$$

where  $P_{dc}$  represents the electric DC power,  $E_e$  the irradiance and  $A$  the cells area of the array.  $I_{dc}$  and  $V_{dc}$  are the current and voltage from the array, respectively.

In the same way, the efficiency of the inverter can be determined as:

$$\eta_{inverter} = \frac{P_{ac}}{P_{dc}} = \frac{P_{ac}}{I_{dc} \cdot V_{dc}}, \quad (3.1-b)$$

where  $P_{ac}$  represents the AC power from the inverter and  $P_{dc}$  the DC power from the array.

Last, the efficiency of the motor pump unit can be indicated as:

$$\eta_{motor/pump} = \frac{E_{hyd}}{E_{ac}} = \frac{mgh}{E_{ac}}, \quad (3.1-c)$$

where  $E_{hyd}$  represents the hydraulic energy realised,  $m$  the total mass of pumped water,  $g$  the acceleration of the gravity and  $h$  the total height up to which water is pumped, counting from the hydrodynamic level.  $E_{ac}$  is the AC energy from the inverter.

The global efficiency of the system is the product of the efficiencies of the components, as:

$$\eta_{global} = \eta_{array} \cdot \eta_{inverter} \cdot \eta_{motor/pump} \quad (3.1-d)$$

### 3.2.2 A Simplified Model for Describing Photovoltaic Array Output

There are basically two approaches in formulating a steady-state mathematical model of a flat-plate PV array operating in a terrestrial environment:

#### (i) The First Approach

The first one is to use an equivalent circuit containing all current sources. The current sources can be at the individual solar cell or PV module level. The solution of this PV array equivalent circuit for output voltage and current from zero to the maximum value yields the complete I-V curve of the total array. For each given computational time interval, the maximum available power can then be calculated from the array I-V curve. The formulation of the mathematical model for such I-V equivalent circuit leads to the already known PV array equation. Considering that the array has  $m$  cells in parallel and  $n$  cells in series, the relation between current and voltage can be

approximated by scaling the characteristics of a single solar cell. Assuming that the cells are identical and neglecting effects due to mismatching of cell characteristics, this relationship can be expressed as, see equation (1.2):

$$I = mI_L - mI_o \left[ \exp\left(\frac{e(mV + nIR_s)}{Anmk_B T}\right) - 1 \right],$$

where  $I$  and  $V$  are the current and voltage of the PV generator,  $I_L$  is the light generated current,  $I_o$  is the saturation current,  $e$  is the electronic charge,  $R_s$  is the series resistance,  $k_B$  is the Boltzmann's constant,  $A$  is the ideality factor and  $T$  is the cells temperature. This is a non-linear equation, whose solution requires the use on numerical methods, which are time consuming. Therefore this approach is not practical for systems performance analysis, and particularly for real time monitoring.

### **(ii) The Second Approach**

The second approach, a novel one, presented in [9], which is easier and faster to calculate, makes use of a power relationship as a function of PV module temperature and solar irradiance [9]. This approach is called the "simplified model" and is reported as describing with sufficient accuracy (of about 3% under irradiance levels above 300 W/m<sup>2</sup>) the performance of PV systems tested in European environmental conditions, although no experimental data were presented to support the statements [9]. Further work is required in the different operating and environmental conditions to support these initial findings drawn in the context of Europe.

For the purposes here envisaged, the power capability of a PV array is defined as the maximum power available from the array at the array DC bus at a given time or time interval  $\Delta t$  [9-11]. It has been stated in chapter 1 that there is a linear dependence of a cell efficiency, and thus of a PV array, with temperature in the form:



$$\eta(E_e, T) = \eta(E_{eo}, T_o) [1 - \beta(T - T_o)].$$

The power capability of any PV module type at a given time or time interval  $\Delta t$  is then basically a function of module temperature  $T$  and solar irradiance  $E_e$  as follows [9]:

$$P_m = P_{mo} [1 - \beta(T - T_o)] \frac{E_e}{E_{eo}}. \quad (3.2)$$

The terms in equation (3.2) are defined as:

$P_{mo}$  - Average module maximum power at a known or reference solar irradiance  $E_{eo}$  and reference cell temperature  $T_o$  (usually  $1000 \text{ W/m}^2$  and  $25^\circ\text{C}$ , respectively).

$\beta$  - Temperature coefficient of module maximum power expressed in % per  $^\circ\text{C}$  (a negative constant usually available from the module supplier for the cell used).

Thus, the power capability for an array string in the array configuration shown in Figure 3.1, with  $N$  number of modules in series is given by:

$$P_b = NK_b P_m, \quad (3.3)$$

where  $K_b = n_d n_{mm} n_{fw} n_{bw} K_d$

and

$n_d$  - Diode efficiency,

$n_{mm}$  - Mismatch factor for series connected modules,

$n_{fw}$  - Field wiring loss factor,

$n_{bw}$  - Intra-module wiring loss factor,

$K_d$  - Power loss factor for dust and dirt on module cover glass and/or power degradation factor.

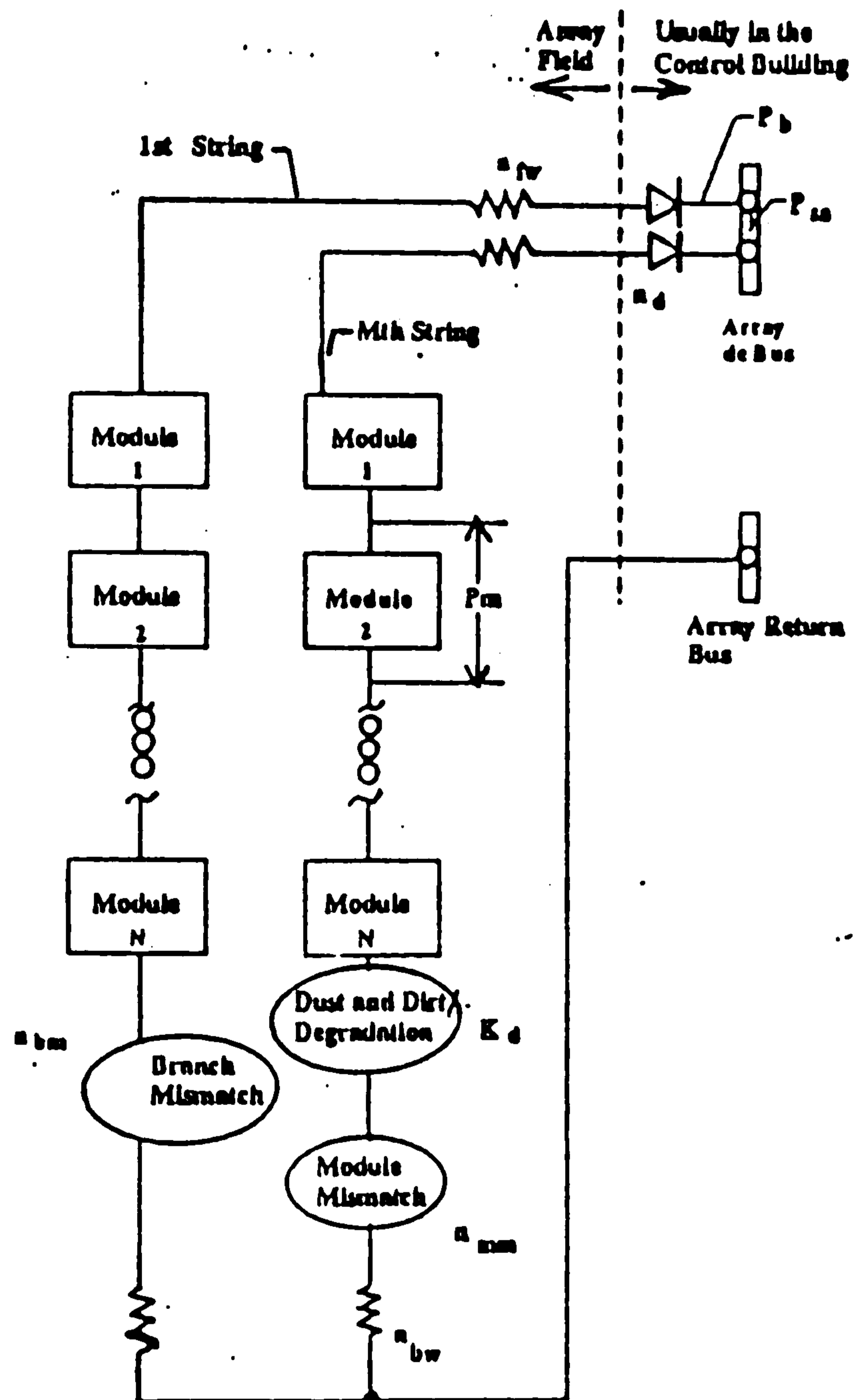

Figure 3.1: Simplified power flow diagram of a PV array field, showing typical string wiring. From source [9].

The resulting array field power capability at a given time interval for M number of strings in parallel is:

$$P_{sa} = Mn_{bm}P_b, \quad (3.4)$$

where  $n_{bm}$  is the mismatch factor for parallel connected strings.

When equations. (3.2) to (3.4) are combined,  $P_{sa}$  can be expressed in the following form, with only three variables,  $P_{mo}$ , T and  $E_e$  (the other terms are constants):

$$P_{sa} = \rho K_{sa} P_{mo} \left[ 1 - \beta(T - T_o) \right] \frac{E_e}{E_{eo}}, \quad (3.5)$$

where  $\rho$  is the correction factor to be established when validating the above equation from actual measurements and

$$K_{sa} = MNn_{bm}n_d n_{mm} n_{fw} n_{bw} K_d;$$

the product MN is the total number of modules in the array.

The array energy capability,  $E_{sa}$ , is the integral of  $P_{sa}$  profiles during a sunlight period:

$$E_{sa} = \frac{\rho K_{sa} P_{mo}}{E_{eo}} \int_{t_o}^{t_f} \left[ 1 - \beta(T - T_o) \right] E_e dt. \quad (3.6)$$

When discrete measurements of  $E_e$  and T are available,  $E_{sa}$  can be expressed as:

$$E_{sa} = \frac{\rho K_{sa} P_{mo}}{E_{so}} \sum_{i=1}^n \{ [1 - \beta(T_i - T_o)] E_{ei} \Delta t_i \}, \quad (3.7)$$

where  $E_{ei}$  and  $T_i$  are average values of irradiance and temperature, respectively, in the time interval  $\Delta t_i$ .

Equation (3.6) or (3.7) represents the simplified model of a PV array. Table 3.1 gives an account on the recommended values of parameters for use in array power capability calculations.

Table 3.1: Recommended values for use in array power capability calculations. From source [9].

Parameter	Value
$n_d$	0.98 for 28 V DC Array Bus
	0.99 for 120 V DC Array Bus
	0.995 for 200-300 V DC Array Bus
$n_{mm}$	0.98
$n_{bm}$	0.98
$n_{bw}$	0.99
$n_{fw}$	0.99
$\beta$	0.0045 K <sup>-1</sup> for monocrystalline Si module
	0.0050 K <sup>-1</sup> for polycrystalline Si module

### **3.3 General Considerations on PV Power Plants**

Terrestrial photovoltaic systems can be categorised into three application types: stand-alone, hybrid and grid connected systems, as shown in Figure 3.2. The stand-alone systems generally involve batteries (or storage tanks in case of water pumping) and are used in remote locations which have no access to a public utility grid. In most stand alone power pumping applications inverters are used, associated with PV arrays. A hybrid system includes a PV array, one or more auxiliary power sources, such as wind or diesel generator, and one or more batteries. Although it requires a more complex controller than the stand-alone or the grid connected systems, its overall reliability is superior to that of the other two systems. The grid connected types are sometimes referred to as cogeneration systems. They normally do not include batteries. Here, the inverter must be capable of accepting the full range of solar array voltage and power excursions, and must be capable of operating at the array peak-power point instantaneously. In this case, the utility network acts as an infinite energy sink and accepts all available power from the PV system. The simplest grid-connected system has a PV array and an inverter as in the case of low-voltage residential grid connection. For high-voltage grid connected systems (i.e., greater than 220 or 380 V AC), transformers and appropriate power switching and protection devices are included.

a) Stand-alone

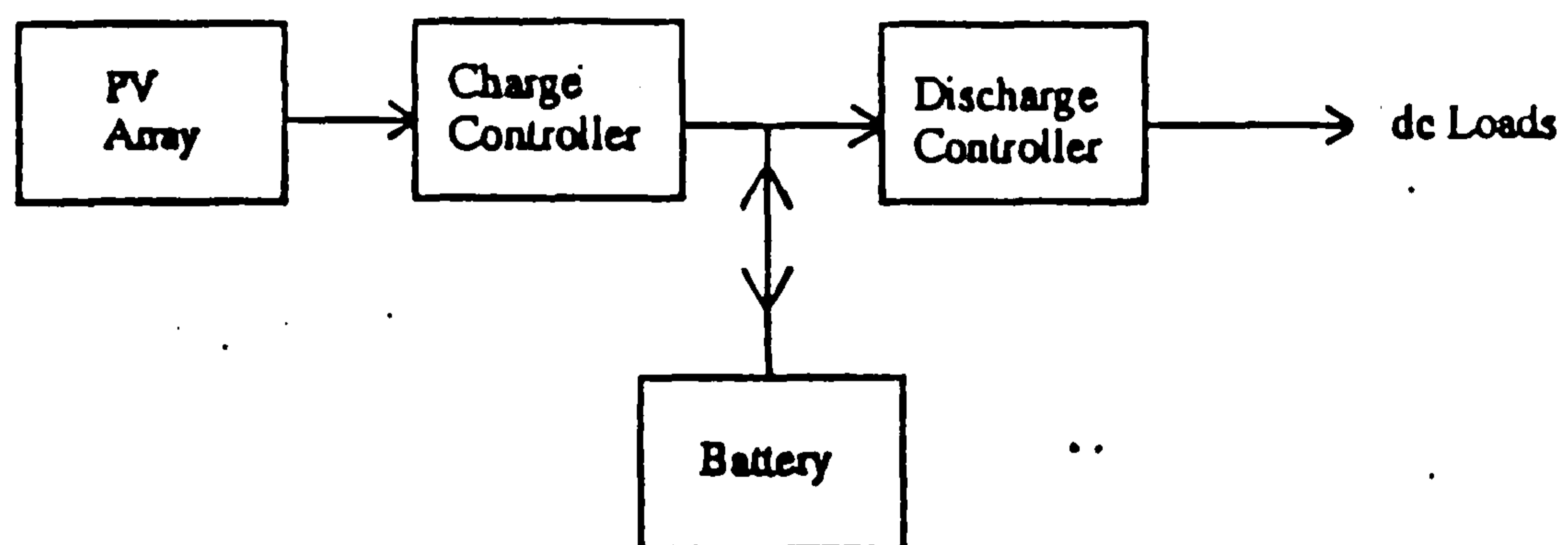

b) Hybrid

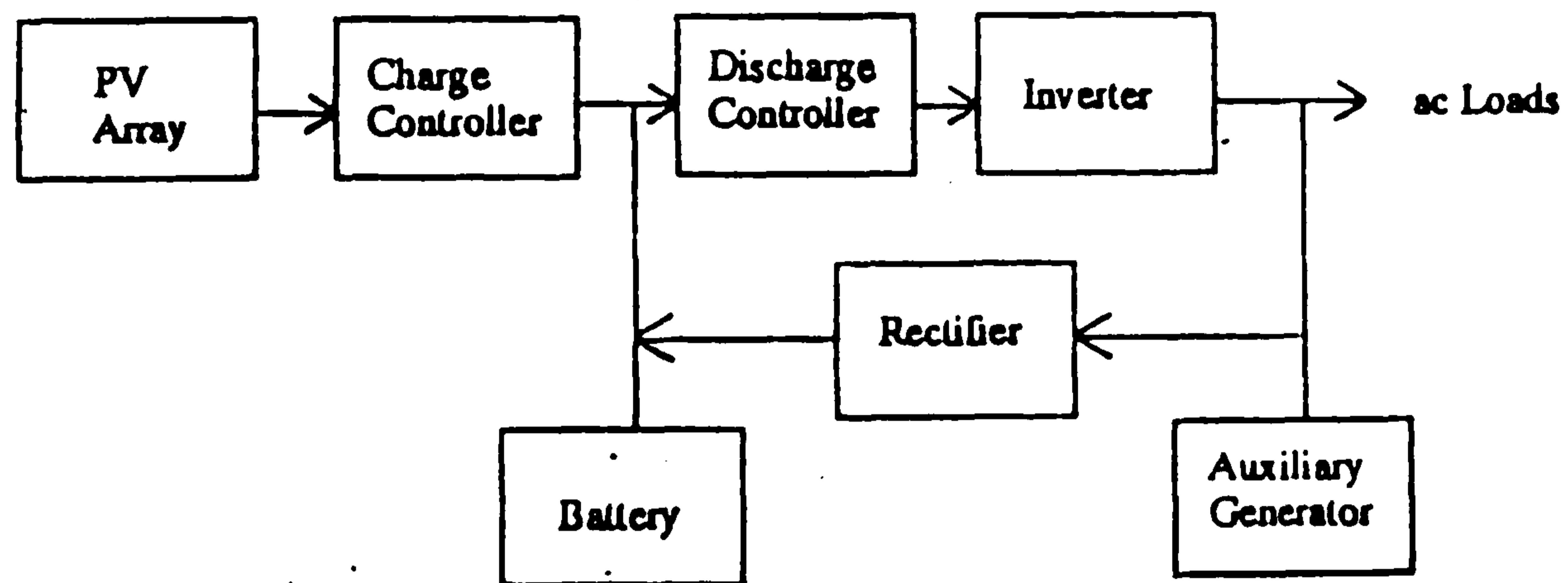

c) Grid-connected, without Battery

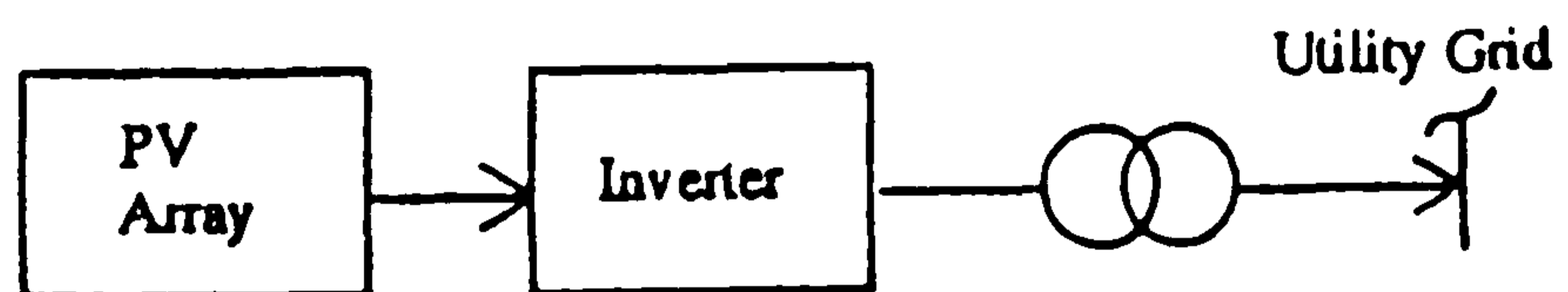

Figure 3.2: Three basic types of PV system configuration: a) stand-alone, b) hybrid, c) grid-connected. From source [12].

For any of the grid connected systems, power factor correction and harmonic filtering devices are essential. However, the grid-interface criteria vary with the utility companies and have yet to be standardised internationally. Most of the inverters now being used for grid-connected applications incorporate peak-power tracking capabilities. That is, the inverter controls the PV array output to maintain operation at its maximum power point which changes rapidly with variations in solar intensity and module temperature. The major constituents of PV power plants are described in the next sections, according to [12-15].

#### **. PV Arrays**

The key factors affecting the electrical performance of the PV array are: solar irradiance, solar cell temperature, solar irradiance angle, electrical wiring resistance and the voltage drop in the series blocking diodes. Others are accumulation of dirt and other particulates on the module cover glass, electrical degradation of a PV module and shadowing of individual cells in PV modules. In terms of their configuration, PV arrays can be divided into flat-plate and concentrating arrays.

#### **. Energy Storage Devices**

Energy storage systems are generally required for stand-alone and hybrid PV plants. However, they increase the cost of the overall system and complicate the power conditioning electronics. Battery systems range from the proven lead-acid, nickel-cadmium and nickel-iron types to the more exotic redox and high-temperature molten salt batteries. A review of these systems, with regard to availability and costs, shows that the first three types will continue to dominate the PV applications market. Other energy storage devices include the fuel cell (with H<sub>2</sub> and O<sub>2</sub> as stored energy), flywheel, pumped water and pumped-air systems.

## **. Power Conditioning and Management**

Power conditioning and management requirements can be grouped into stand-alone and grid-connected categories. The key considerations are efficiency, lifetime, reliability and degree of autonomy. The power electronics in stand-alone systems may be simple or complex, depending on the power level and the extent of autonomous operation. As the power level goes up, the number of sensing and control functions generally increases, thereby decreasing the system reliability. Power conditioning requirements are more severe for a stand-alone system because of the need for effective battery charge control and discharge protection. Hybrid systems require a large amount of sensing and control because of the need to optimise the overall operation of the system, considering (i) available power from the PV array, (ii) battery operation constraints, (iii) operating constraints of the auxiliary power source, such as diesel, to optimise its efficiency and life and (iv) load management criteria. A hybrid system needs therefore a dedicated computer for real-time monitoring and control functions. A key consideration in the design and operation of inverters is how to achieve high efficiency with varying input and output load, and thereby reduce the heat dissipation in the inverter.

## **. Loads**

Size, cost and configuration of a stand-alone PV system and its dc bus voltage are strongly dependent on both transient and steady-state characteristics of the loads. For low-power stand-alone PV applications, only dc loads should be selected because an inverter, and hence its losses, can be eliminated. Individual loads are characterised by their input voltage and power requirements. DC loads consist of resistive, constant current, constant voltage or constant power in the applied voltage range. Typical dc loads are lamps, radios, stereo, TV, refrigerators, battery charging and motors. Fluorescent lamps, power supplies with transformers and high frequency converters used in microwave oven power supplies comprise a category of ac loads which utilises induction coupling, resulting in energy transformation.



### **3.4 The Technology of PV Solar Water Pumping**

#### **3.4.1 General Considerations**

Water is one of the primary resources necessary to support life, as has been so tragically demonstrated in recent years by several droughts in the Southern African region in general, and in Mozambique in particular. Even in regions where the rainfall does not fluctuate so severely, access to a clean and reliable water supply can make a vital difference to the health and quality of life of a rural community. In many of these areas water exists below the ground, and throughout the developing world the most widespread way of raising it to the surface is still by hand pump. The principal mechanised power source is the diesel engine, but this is often beyond the means or technical capability of small communities. Although the number of units in the field is still small, solar photovoltaic powered pumping systems offer many advantages over the more traditional technologies [16]. Because there are few moving parts, maintenance is reduced to a minimum, and reliability is very high. Also, because the time of greatest water demand usually coincides with the maximum daily solar energy, the available pumping power is well matched to the demand. Solar pumping was first introduced into the field in the late nineteen-seventies, and since then manufacturers have refined their products to give considerable increases in performance and reliability [16]. The steady fall in prices of solar photovoltaic panels means that solar pumping is becoming economic for an increasingly wide range of applications.

A significant part of the early development of solar technology was concerned with water pumping [17-19]. A solar steam engine pumped water at the Paris Exposition in 1878 [16]. The development and commercialisation of a viable solar-thermodynamic pump was pioneered by the French company Sofretes [16] following early work in Senegal. In the 1970's many of these pumps were installed around the world, particularly in the African Sahel and Mexico. Development of photovoltaic pumps was also pioneered in France. The first systems used a Pompes Guinard motor-pump comprising a surface-mounted permanent-magnet DC motor driving a submersed

centrifugal pump via a vertical shaft. The motor was connected directly to the PV array. Several demonstration units were installed in the 1970's. In 1978 a team at the World bank presented a compelling case for a programme to apply small PV pumps for irrigation ("micro-irrigation") on a huge scale [16]. A goal of 10 million pumps installed by the year 2000 was presented as appropriate, as having a significant impact on world food production yet representing 10 percent of potential farmer users. Economic analysis suggested that small PV pumps would be economic with array costs of around US\$5/W<sub>p</sub> (1978 dollars). As a result of the work mentioned above, as well as other interests, the United Nations Development Programme (UNDP) provided funding for the Global Solar Pumping Project (GLO/78/004), to be executed by the World Bank [16]. In July 1979 consultants were appointed by the World Bank to evaluate, test and demonstrate commercially available small-scale solar powered irrigation pumping systems. At the time the technical feasibility of solar powered pumping had been demonstrated in a limited way, but the technology was clearly immature and expensive. The purpose of the project was to advise the UNDP and the World Bank on the way in which solar pumps should be developed and applied so as to provide an appropriate method for irrigation under the conditions that prevail on small farms in developing countries. The capacity required amounted to flows in the range one to five litres per second and static heads up to 7 metres. Pumps of this capacity have outputs in the range 150 to 500 W and can irrigate areas of between 0.5 and 1.0 hectares, depending on the crop and efficiency of water distribution. The target cost of water delivered was US\$ 0.05 per cubic metre (1979 prices). When the project was defined both solar-thermodynamic and photovoltaic technologies were considered to be of equal merit and potential [16]. Following the review, a state-of-the-art report was released in 1979. This was followed by an international call for offers, together with 250 questionnaires sent to potential suppliers. This resulted in only 13 suppliers being able to realistically supply equipment. A total of twelve pumps were tested in the field, four in each of Mali, Sudan and the Philippines. One system was solar thermodynamic and the remainder were photovoltaic. Field testing was

conducted in 1980, and PV modules, pumps and motors were also tested as components in the UK and USA. Three systems performed better than their rated value, two systems were within 10% of rated performance, and five systems performed significantly below rating. Two systems (including the solar thermodynamic pump) failed to operate. The detailed results of this work were published in 1981 and concluded that there was indeed considerable potential for the use of solar pumps for irrigation, but that none of the products then available on the market were yet suitable for widespread use. Extensive recommendations were made on improving performance, reliability and cost. The project also reported that meeting the target irrigation water costs of US\$ 0.05/m<sup>3</sup> would not be easy but that a significantly higher cost would be acceptable for village water supply. The UNDP and World Bank decided to continue the work to the point where really widespread demonstration (Phase II) could be contemplated. Important new activities included:

- . Assessment of prospective countries for participation in Phase II (countries short-listed were Bangladesh, Brazil, Egypt, Kenya, Mexico, Pakistan, Sri Lanka and Thailand);

- . Procurement of improved commercial systems and sub-systems for testing in order to qualify them for use in Phase II.

Based on the experience gained in Phase I, exacting specifications were developed to define the performance of improved systems, and tenders were invited.

Of 64 systems tendered 12 were purchased and laboratory tested in the UK in 1982/83. The final report was released in 1983 and this concluded that performance had improved but that there was still the need and scope for improvements in performance and reliability. From the economic studies it was concluded that PV pumps were broadly competitive with the primary alternatives and could be justified in sunny

regions where diesel costs are high, wind speeds low and a steady year round demand for water exists. It was shown that village water supply would in general become economic before irrigation. The final output of the work was the Handbook on Solar Water Pumping which was published by the World Bank in 1984 [16]. Given the lead of the UNDP/World Bank project, PV pumps have, over the past decade, evolved to be simple and reliable. A total of more than 10000 units have been installed to date, of which 30-40% are in developing countries [16].

### **3.4.2 The Status of PV Water Pumping in Developing Countries**

A review on the status of PV pumping in four developing countries is presented here based on references [16,20].

#### **. Mali**

Mali provides a good example of PV solar pumping experience. This country gained a lot of experiences in installation, finance, operation and maintenance of PV pumping systems. Due to the large seasonal variation in surface water availability, Mali has many large pumping projects, with a total of around 15000 boreholes and wells. Most of these are handpumps and around 2000 are diesel or kerosene powered. Comparatively few (around 200) are solar pumps. Mali Aqua Viva (MAV), a local Non Governmental Organisation, pioneered the introduction of solar pumps in Mali in 1977, and their success has led to other organisations, like the United States Aid Agency (USAID), the United Nations Development Programme (UNDP) and the German Society for Technical Co-operation (GTZ), adopting PV as a power source for pumping.

Eighty percent of PV pumping in Mali is from boreholes and about 15% from surface water. In 1992 there were 157 PV pumping systems in Mali. The total installed array capacity is estimated at 220 kW<sub>p</sub>. The most popular configuration is that of a submersible motor/pump set, accounting for 43% of installations. Until recently the

second most popular was the surface motor/submerged pump, which still features in 25% of present installations. The remainder are either surface, floating or positive displacement devices. Heads are typically in the range 30-40 metres. Lower heads are also common, but there are only 15 sites with head greater than 40 m. The power ratings range from 160  $W_p$  to 12960  $W_p$  for the largest installation, with the mean around 1500  $W_p$ . Outputs are in general found to be consistent with the manufacturers predictions. The chief suppliers of modules are France Photon, Photowatt and Arco Solar, accounting between them for nearly 70% of the total installed power. The main subsystems suppliers are Guinard and Grundfos with 25% each, closely followed by Total with 18%. However, a breakdown of subsystems suppliers since 1988 shows that Guinard have dropped out of the market entirely. This is due to problems with their surface motor units (Alta-X) which were replaced after 2-5 years due to their poor design. However, the introduction of AC submerged pumps in 1980 led to greater durability, and this is the preferred configuration for new boreholes.

The high investment costs for PV pumps means that outside donors will have to be involved with the financing of village PV pumping schemes for the foreseeable future. However, the villagers accept the principle that they should contribute in some way, and for Mali Aqua Viva installations the beneficiaries contribution to the capital costs now stands at 20%. Villagers must also pay for maintenance and repair.

#### **. Morocco**

More than 100 solar pumps have been installed by the Ministry of the Interior, and there are probably up to 100 other systems installed privately. Most installations are rated at around 1  $kW_p$ , and pump through heads of 15-50 m. The Ministry of the Interior, in its plan for 1988-1992, intended to equip 2,000 sites with solar pumps.

## **. Brazil**

Brazil along with India and China is one of the few developing countries with photovoltaic manufacture and systems integration in the country. The organisation manufacturing PV modules and systems is Heliodinâmica of São Paulo, which entered the PV market in 1981. By 1989 the company had achieved sales of 600 kW<sub>p</sub> per annum with revenues exceeding US\$ 2.6 m. However the market for PV pumps has not developed in Brazil with only approximately 53 systems installed by September 1990.

## **. India**

The largest number of solar pumps in one country is in India, where more than 1000 systems have been installed for village water supplies. Good responses have been reported along with wide user acceptance. The modules and systems have been indigenously designed and manufactured by Central Electronics Limited (CEL) in India. The potential for application for PV in India is so great that several other companies have started PV production including Bharat Heavy Electricals Limited (BHEL) and Rajasthan Electronics and Instruments Limited (REIL).

### **3.4.3 Description of the Hardware**

A PV pumping system can be divided up into four major components:

- . The PV array;
- . The power conditioning (if any);
- . The load (i.e., an electric motor coupled to a pump);
- . The water storage and distribution system.

#### **3.4.3.1 The Technology of PV Arrays**

The basic unit of a photovoltaic array as far as the buyer is concerned is the PV module. In water pumping applications both crystalline silicon and amorphous silicon

modules are used. Nevertheless, modules of crystalline silicon are much more preferred in this application, as they are more reliable than those based on amorphous silicon, although the cost per unit of energy provided is also higher.

#### **3.4.3.2 The Technology of Motor/Pump Sets**

In some cases it is feasible to utilise off-the-shelf, mass produced motors and pumps. However, some manufacturers have developed specialised pumps and motors with an above average efficiency to minimise overall system costs. The pump/motor subsystem operates in a different way to a conventional motor because the power supply varies as the incident solar energy changes. Most motors are designed for maximum efficiency at certain voltage/current characteristics, and performance can drop off quickly away from this operating point. In a solar powered system the motor/pump subsystem must be able to work fairly efficiently over a range of voltage and current levels. Although these specialised motors cost more than conventional motors, this is outweighed by the cost saving in terms of the number of PV modules required.

The usual measure of the motor performance is the power efficiency, which is the ratio of hydraulic output power to electrical input power. This is an instantaneous measurement, and is a maximum for the design conditions. The daily energy efficiency of the subsystem is a time average of the power efficiency. This depends on variations in the power efficiency, and thus on the solar irradiance profile for the day. The daily energy efficiency is more useful, as this determines the required array size for a given hydraulic duty.

The motor/pump requires a certain minimum power input to start working, and different pump types respond in different ways. A centrifugal pump will begin to rotate at very low light levels, but will not lift any water through the head until the pump reaches a certain speed. This power threshold increases with the required pumping head. A positive displacement pump needs a very high torque to start, as the pump is

pushing against the whole head. Thus more current will be needed for starting than running. This can mean that without power conditioning the pump will not start until quite a time after sunrise because the maximum current from a PV cell is limited for a given irradiance level, and at high currents, the cell is far from its maximum power point. The starting and stopping threshold of a pump is an important parameter, because it determines how much of the total daily insolation is not used for useful pumping. A typical starting threshold might be  $300 \text{ W/m}^2$ . On overcast days the irradiance may not exceed this and the pump may not operate at all.

### **. Motor Technology**

There are three types of motor commonly used for PV pumping applications, and each has its good and bad points. For this reason no one type has yet emerged as a standard. These types are [16,20-21]:

- . Brushed type permanent magnet DC motors;
- . Brushless type permanent magnet DC motors;
- . AC motors.

The immediate choice is between AC and DC motors. In terms of simplicity the DC motor is an attractive option because PV modules only produce direct current, and less specialised power conditioning equipment is needed. In many low power situations the array can be directly coupled to the motor with no electronics at all. For higher power applications ( $>250 \text{ W}$ ) an AC motor may be used in conjunction with an inverter. The range of AC motors available is much greater and the prices are generally lower. However the inverter is a relatively expensive piece of equipment and for small systems, the savings from using a cheaper AC motor may be offset by the additional cost of the inverter (around 1000 US\$). This configuration is therefore usually only the norm for larger systems. Commercially available inverters are designed to perform best at certain input and output characteristics, and the variable nature of the PV power



supply may adversely affect their efficiency. It should be noted that in a recent study of pump failures in Mali, 20% were caused by inverter failure, the second largest cause after problems due to dirt [16]. The DC units used for PV applications are generally of the permanent magnet type. In conventional DC motors the magnetic field is produced electromagnetically by the field winding. While more output power can be obtained in this way for a given motor size, valuable energy is consumed by the field windings. For PV driven motors a permanent magnet is used to produce the magnetic field and so no power is consumed in the field windings, leading to higher efficiencies. Smaller PV array sizes may therefore be used for the same hydraulic duty. It is inherent in the design of DC motors that brushes are needed to transmit the power to the commutator. These are usually made of graphite, and so will wear down over a period of time and require replacement. A typical replacement interval for modern pumps is every two years (or 2000 to 4000 pumping hours). Although replacement is not difficult, it does entail removal of the pump/motor (for submerged units) and means that villagers must be trained in an extra aspect of maintenance. There will obviously also be increased maintenance costs associated with brushed motors. In the brushless DC motors the permanent magnet is the central rotor, and the field windings are electronically switched by means of a rotor position sensor. The extra electronic circuitry adds cost and possible reliability problems to this choice of motor, but during the last few years designs have improved greatly. Many established manufacturers now use brushless motors.

### **. Pump Technology**

Pumps can generally be divided into two categories, centrifugal and positive displacement [16,20-21]. These two types of pump have inherently different characteristics and are suited to different operating conditions. Centrifugal pumps are designed for fixed head applications and their water output increases in proportion to their speed of rotation. The principle of operation is that water enters at the centre of the pump and a rotating impeller throws water outwards due to centrifugal force. The

water outlet is on the outside of the impeller cavity and thus a pressure difference is created between inlet and outlet of the pump. A pump with just one impeller is called single stage, but most borehole pumps are multistage. This means that the outlet from one impeller feeds into the centre of another, each one adding a further pressure difference. When the speed of rotation gets high enough this pressure will be enough to lift water through the head and pumping will begin. Centrifugal pumps have an optimum efficiency at a certain design head and design rotation speed. At heads and flows away from the design point their efficiency decreases. Centrifugal pumps are seldom used for suction lifts of more than 6 or 7 metres and are more reliably operated in submerged or floating motor/pump sets (in fact the theoretical absolute maximum for suction lift is about 9 m). This is because they are not inherently self priming and can easily lose their prime at higher suction heads. However, submersible pumpsets may lift water from many tens of metres, depending on the number of stages and operating speed.

Positive displacement pumps have a water output which is almost independent of head, but directly proportional to speed. These pumps employ a piston/cylinder arrangement, or cavity of variable size, and so when the pump starts, water is forced against the entire head. Frictional forces are higher than in centrifugal pumps, because contact of moving surfaces is necessary to "positively displace" the pumped fluid. At high heads and low speeds the frictional forces are small relative to the hydrostatic forces. Consequently for high heads displacement pumps may be the more efficient choice. At lower heads (less than about 15 m) the frictional forces are large compared to the hydrostatic forces and so efficiency is low and a displacement pump is less likely to be used. A factor to consider when coupling a positive displacement pump to a PV array is the cyclical nature of the load on the motor. This causes variations in the electrical impedance of the load as seen by the PV array, and so the array will fluctuate around (and hence away from) its maximum power point. This is particularly a problem during the high torques experienced on starting. This means that electronic power

conditioning is sometimes needed to smooth out these impedance changes by dynamically matching the array and motor impedances. Smoothing the motor torque can also be performed mechanically by the addition of a flywheel or counterweight. These power matching problems are not much experienced by centrifugal pumps, which exert a smooth, constant torque on their motor.

### **. Subsystem Configuration**

There are several different system configurations that are suitable for use with solar power. The five main types are the following [16,21], see Figure 3.3:

. **Submerged Motor/Pump** - This is useful for medium depth (<50 m) borehole applications using centrifugal pumps. Advantages are that it is easy to install with flexible pipework, and the motor-pumpset is submerged, away from potential damage. Motors may be DC (brushed or brushless) or AC, although AC is most common, particularly for high power and deep borehole applications;

. **Surface Motor/Submerged Pump** - This design allows easy access to the motor for brush changes, but is now becoming increasingly unpopular for a number of reasons. Reliability tends to be poor when used with centrifugal pumps due to bearing wear, and installation is costly. There are also significant power losses from the shaft bearings due to vibration and friction. Data from a monitoring programme in Mali has shown that most surface motor units are being replaced by submersible systems;

. **Jack Pump (Reciprocating Positive Displacement Pump)** - These are also known as "nodding donkey" pumps and are mainly used in very deep, low flow borehole applications. The motor is mounted above ground and features a balance weight to counter the cyclic force exerted on the motor by the pump. Some designs use different gear ratios for different parts of the cycle to improve the matching on the power stroke. Because the shaft does not rotate but moves vertically, it does not suffer the

bearing-associated problems. Above ground components tend to be heavy and robust, and installation is expensive;

. Floating Motor-Pump Sets - The portability of the floating pump set makes it ideal for irrigation pumping from canals and open wells. The pump moves with the water level, and so is not likely to run dry, unless the source dries. The arrays are often mounted on wheels to allow easy movement. Obviously this design is not suitable for borehole pumping;

. Surface Suction Pumpsets - This configuration is not generally used unattended, due to self starting and priming problems, particularly at high suction heads. The physical limit on suction heads is about 8 m, but it is better to operate at the minimum possible.

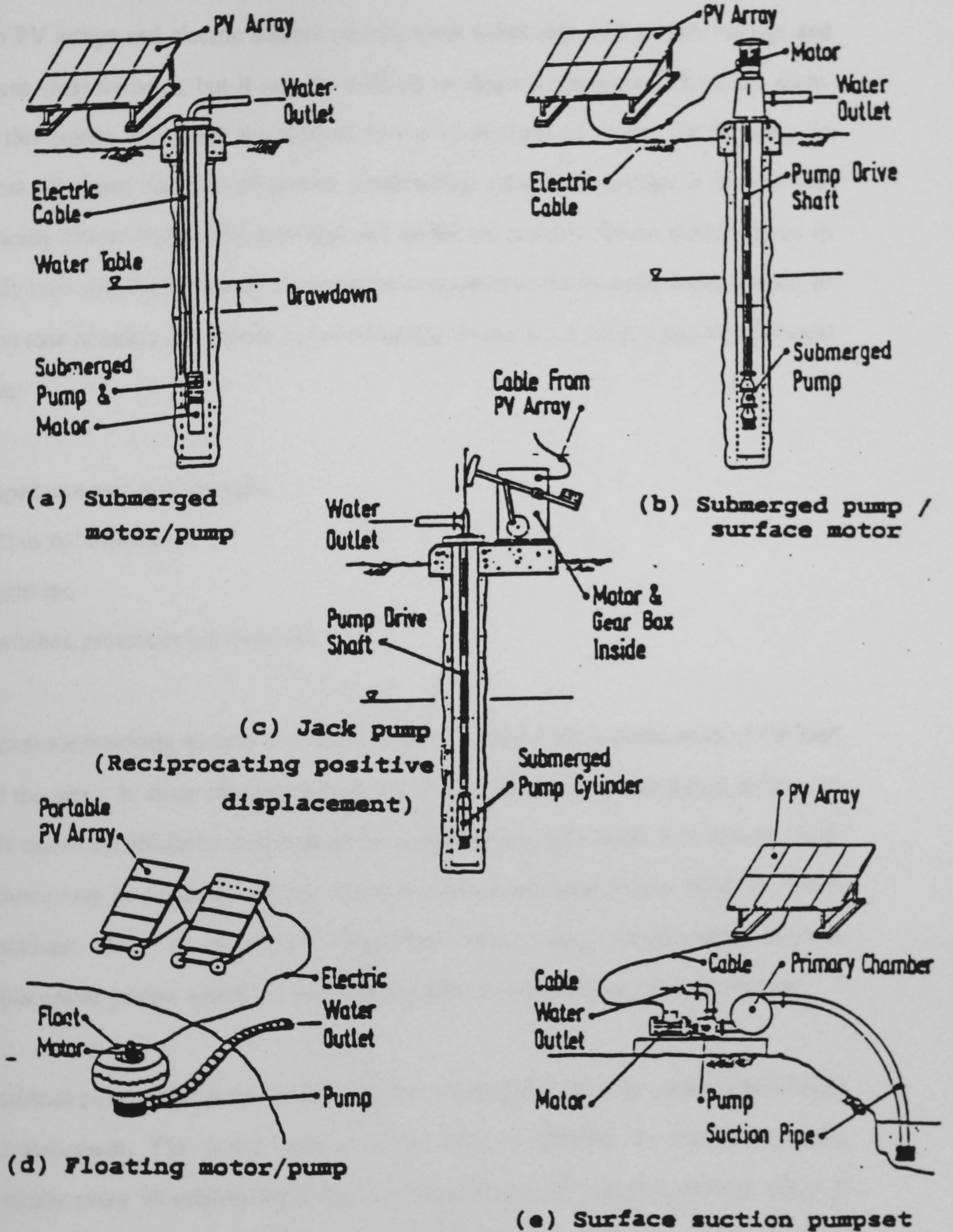

Figure 3.3: Various motor/pumpset configurations, from source [16].

### **3.4.3.3 Power Conditioning**

Both PV arrays and electric motors operate most effectively with certain voltage and current characteristics, but it may be difficult to obtain a good match between them. For this reason it is often worthwhile to use some form of power conditioning. In almost all cases the use of power conditioning equipment implies a power loss (typically 5% or less), additional cost and additional possible failure mode. Hence to justify their use, the increased cost must be compensated for by extra water output, or in the case of safety equipment, better reliability. Power conditioning may be of several types:

- . Impedance matching devices;
- . DC to AC inverters;
- . Batteries;
- . Switches, protective cut-outs, etc.

Impedance matching devices are used to match the electrical characteristics of the load and the array. In these conditions both the motor and the array can function close to their maximum efficiency over a range of conditions and light levels. For instance, high currents may be produced so that the motor/pump will start in low solar irradiance conditions. This is particularly important when using reciprocating positive displacement pumps, which have to work against the full pumping head to start-up.

Maximum power point trackers (MPPT's) are "intelligent" devices, usually employing a microprocessor. The power output of the array is sampled at frequent intervals (typically every 30 milliseconds), and a comparison made with the previous value. If the output power has increased then the array voltage is stepped in the same direction as the last step. If the power has decreased then the voltage is stepped the opposite way. In this way the MPPT always allows the array to operate at its peak power point.

A cheaper alternative is just to use an electronic controller to hold the array voltage constant. This tends to hold the array fairly close to its maximum power point over quite a range of conditions, due to the nature of its electrical characteristics (the maximum power point voltage does not vary over quite a range of insolation levels).

Inverters convert direct current to alternating current, and are used to enable PV arrays to drive AC motors. Inverter efficiencies can be as high as 97%, but circuitry should involve some form of impedance matching for best results. Choosing an inverter is critical to its effectiveness in the system, as many units are designed for certain characteristics, and have a poor part-load efficiency. However, there are now several variable frequency inverters on the market that have been specially designed for PV applications. These have so far proved to be reliable and efficient (>95%) even on part load.

Batteries also provide a means of impedance matching. A battery can usefully store the energy from the array at irradiance levels too low to start a pump. Pumping can therefore start at low or even zero light levels as required. Because of their fixed voltage operation, designers can optimise the motor/pump subsystem for maximum efficiency. One drawback is that battery efficiency may be as low as 70% through self-discharge, and so this may offset the benefit gained at low irradiance. They also require regular maintenance and have a shorter operational life than the rest of the pumping system. Very few solar pumping systems include batteries at present, although research work continues in this field.

Switches and cut-outs protect components against power surges or damaging electrical conditions that may be caused by failure of other components, incorrect use or connection, or other possible malfunction. A system involving batteries may include a low-voltage cut-off to protect the batteries against deep discharge. If a pump runs dry, the motor may over-speed and burn out. Therefore if this is a possibility (i.e., with

unattended borehole systems) a water level detector or over-speed cut-out device should be used.

#### **3.4.3.4 Water Storage and Distribution**

The characteristics of a delivery system have a significant effect on the size of the required pumping system, and thus on the overall system's cost. The main factors to consider are [16]:

. The volumetric efficiency of storage and distribution - This is the fraction of the pumped water which actually reaches its point of use. This is particularly vital in irrigation applications, in which a great deal can be lost. This would mean a larger pump, a larger array and thus higher costs;

. The total pumped head - This is the sum of the static head (pressure needed to pump the water up to the level of the storage tank), the dynamic head (pressure loss due to friction and turbulence in the pipework and any increase in head due to drawdown in the well or borehole;

. The actual cost of the storage and distribution system itself - For a large irrigation system this could be a significant part of the total system cost.

With conventional pumping systems water is available on demand, and so short term storage is not such an important consideration. However, with solar pumping there may be significant variations in sunshine from day to day, and so water may not be available when it is most needed without some form of storage. The storage requirements for village supply and irrigation are rather different. For irrigation, above ground storage is not feasible due to the large quantities of water involved, and would in fact, rarely be required. On a day to day basis, variations in supply are smoothed out by storage in the root zone of the crop. However, for larger systems some storage may



be provided in the form of a shallow pond, which can be constructed very cheaply with local materials and labour. For village water supplies some storage is essential, and should be adequate for several days water supply. Although 5 days may be desirable, in practice only about 2 or 3 days is usually affordable. A typical example would be a central raised storage tank close to the pump (to minimise dynamic head losses) and a piped distribution system to stand-pipes. Tanks should be wide and squat rather than tall and thin, or the total head may significantly increase as the tank becomes full. Pipes, being a cheap part of the system should therefore be oversized to reduce dynamic losses to a minimum.

The distribution system for small scale irrigation scheme consists of (i) the conveyance network to move water from the pump or storage tank to the field and (ii) the field application method to apply water to the crops. As far as village water supply is concerned, in many cases there may be no distribution system, with villagers fetching their water from a tap at the storage tank. This reduces the head loss and reduces piping costs. A prime factor to consider when deciding on a distribution system for livestock or village water supply, is the number of people or animals to be supplied by one pump. There are few economies of scale with solar pumping, and it can therefore be expected that several pumps are likely to have around the same cost as one pump with piped distribution. If individual well-yield are low this will be the limiting factor, but overall cost needs to be minimised for each application, and due allowance made for the cost of drilling extra boreholes or wells. The number and positioning of stand-pipes should take into account the distance villagers must walk to fetch their water. The time used in collecting water must be weighed against the cost of additional piping.

#### **3.4.4 Operation and Performance of PV Pumping Systems**

As it is usual to buy a complete system, it is more useful to have a feel for which systems perform best in which conditions, and over what range of conditions operation

is possible. Figure 3.4 illustrates the typical ranges for different pump types as a function of output and head. The shading indicates the areas of the graph in which various configurations are most suitable, and can be used as a guide when performing a technical appraisal or life cycle cost analysis.

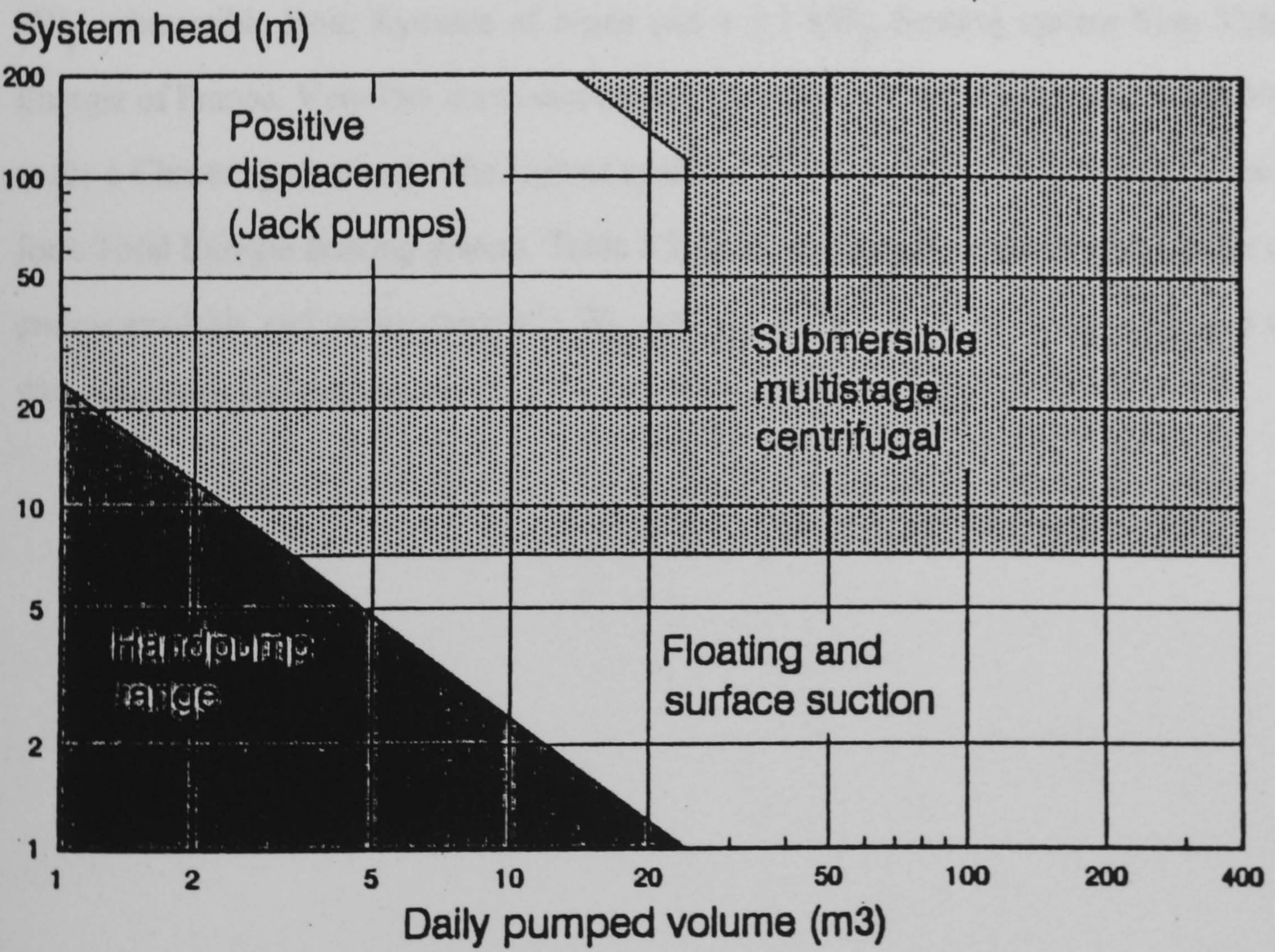

Figure 3.4 : Configuration of pumps for various heads and volumes, from source [16].

The efficiency of conversion from the daily solar energy to hydraulic energy should be at least 3% and ideally more than 4% for a good system.

### **3.4.5 Available Equipment**

The market now offers PV pumping equipment to suit a wide range of scenarios, from the smallest of a few tens of  $W_p$  to the largest at several tens of  $kW_p$  [16]. However, the bulk of sales is for systems rated at less than 1500  $W_p$ , and it is in this range that most manufacturers possess most of their experience. The smallest units on offer are a 17  $W_p$  domestic pump from Heliodinâmica of Brazil and a 47  $W_p$  submersible from Solarjack of the US. At the other end of the scale, the largest standard units are a 3.7  $kW_p$  submersible from Kyocera of Japan and a 5.1  $kW_p$  floating system from Total Energie of France. Very few maximum heads exceed 120 m with the highest being 300 m for a Chronar jack-pump. The highest specified flow rate is 700  $m^3/day$  at 5 m head for a Total Energie floating system. Table 3.2 gives an account of the configurations of pumps available and power ranges in  $W_p$ , and appendix C a list of major suppliers of PV water pumping equipment.

Table 3.2 : Configurations of pumps available and power ranges in  $W_p$ , from source

[16].

SUPPLIER	SURFACE SUCTION	FLOATING	SUBMER-SIBLE	JACK	PROG. CAV.
BP Solar	yes 80-720	yes 320-480	yes 560-1400		
Chloride Solar		yes 320-640	yes 740-1480		
Chronar	yes 120-480			yes 160-960	
Dinh Co.	yes 100-800		yes 975-1625	yes 975-1625	
Duba	yes 120-200		yes 640-1280		
Fluxinos	Oscillation pump 360 Wp				
Grundfos			yes 250-1500		
Heliodinamica	yes 17-490		yes 735-1470		
Helios Technology	yes 270		yes 270-1800		
Hydrasol		yes 300-1400	yes 300-900		
KSB		yes 530	yes		
Kyocera			yes 50-3700		
McDonald	yes 130-1680		yes 320-1590		
Mono/Suntron	yes 120-1680				yes 120-1680
Siemens		yes 550-825	yes 770-1540		
Solarjack			yes 47-94	yes 106-424	
Total Energie		yes 240-5120	yes 640-3200		

### **3.4.6 Equipment Costs**

Recent years have seen the cost of PV solar water pumping falling, largely due to reductions in the costs of PV modules. This trend is expected to continue in the next decade with the advancement of PV technology and more efficient manufacturing processes. The costs of motor/pump units or inverters or any power conditioning piece of equipment are not likely to decrease, although there should be some steady improvement in efficiencies and reliability. The costs of each component at present are as follows [16]:

#### **. PV Arrays**

The base price to the consumer for PV modules is presently about 5 US\$/W<sub>p</sub>. Array support structure cost is between 1 and 2 US\$ per W<sub>p</sub>. Racks are available to hold 1, 4 or 8 modules. Tracking array support structures add about 4 US\$/W<sub>p</sub> onto the system price.

#### **. Motor/Pumpsets**

There is a considerable variation in prices from configuration to configuration, thus they are dealt separately.

. Surface Suction - The bulk of the prices range between 1000 US\$ and 1500 US\$ with a mean of 1330 US\$. This corresponds to between 2 and 4 US\$/W<sub>p</sub> for the mid-range pumpsets, rising as high as 10 US\$/W<sub>p</sub> for the smallest units (120 W);

. Floating - There are very few floating pumps on the market (compared to surface suction or submersibles). For a small to medium sized units these pumps are priced around 1000 US\$;

. Submersibles - Most of these motor/pumpsets lie in the range 1000 to 3000 US\$, with a mean of around 2300 US\$, which corresponds to about 1 to 3 US\$/W<sub>p</sub> of rated

array power. The smallest and cheapest unit is the Solarjack SDS at 425 US\$, designed for use with arrays as small as 47  $W_p$ . Another small, low-cost unit is the Robby-24 from Helios at 702 US\$. In general, prices tend to vary more between different manufacturers than for different pumps within the size range of the same manufacturer;

. Jack Pumps - As with floating pumps, the sample is quite small, but shows that jack pump prices vary in a well defined way with pump size, being between 10 and 15 US\$/ $W_p$  of the rated array power. As a lower boundary condition on this, no jack pumps were found costing below 3000 US\$. The mean price over the whole sample was 5870 US\$ with no units over 7500 US\$.

#### **. Power Conditioning and Control Equipment**

At the lower end of the price range, a simple electronic control module costs between 400 and 500 US\$, and will be sufficient for many small DC systems. Starter units (current boosters) are available for as little as 50 to 100 US\$. The specialised inverters for PV applications are priced at between 1000 and 2000 US\$ for power rating up to about 1500 W, although some higher power devices cost as much as 4000 US\$.

#### **3.4.7 Water Sanitation**

Consumption of non-potable water is a source of many diseases in Mozambique, especially among children. Cholera and diarrhoea count among common diseases caused by the consumption of improper water. According to the UNDP Report [22] 60% of the population in Mozambique still drinks non-potable water. Thus, in case of village water supply water should be purified before it is supplied to the community. Rigorous measures of purification have to be taken especially if the source of water are ponds, wells, rivers or any open source. As far as boreholes is concerned, there is a need to analyse the quality of water after drilling. If it is proper for drinking it can be used without previous treatment. Nevertheless it may be important to undertake this

type of analysis periodically, for instance every five years. If it is not proper, then measures for purification have to be taken. Storage tanks for drinking water should always be covered to ensure a clean supply, and prevent entry of dirt, insects and animals.

### **3.5 Monitoring Systems**

Monitoring as described herein deals with the collection, recording and transmission of data for archival storage and off-site analysis of plant performance. Monitoring equipment generally consists of a serial chain of sensors, signal conditioning devices, the data acquisition system (DAS), and data transmission/receiving devices. This whole chain is defined as the data collection system (DCS), the heart of which, the DAS, is the most critical part. The DAS itself has several elements each of which can cause a failure in the data collection process. DAS's can be classified into "PC-based" systems and "Dataloggers". The PC-based systems are those which use an IBM PC, or its compatible. A datalogger is thus any DAS which does not use the PC for on-line data collection and storage. Almost all dataloggers commonly used make full use of PC's for the initial set-up and programming of the input data and also for subsequent analysis and presentation of results after retrieving stored data. In the following paragraphs, the state-of-the-art hardware for the principal elements of the DCS is described, in accordance with reference [12, 23-25]

#### **. PC-Based DAS**

One of the best arrangements for data acquisition and processing is a PC-based system. It basically consists of "front-end" electronics, a PC and simple software to process, calculate and store specified engineering parameters. The "front-end" electronics provides the interface between the sensors and the PC. Most dataloggers and A/D conversion equipment can serve as the front-end-electronics.



### **. Dataloggers**

Dataloggers are smaller low-cost data acquisition units, with their own microprocessors and limited data storage space. Most of the commercially available and custom-designed units have been found to be very versatile and rugged. For projects that require hourly data recording continuously, dataloggers combined with periodic transfer of data, via modem or using an external storage module, provide a very reliable and cost-effective approach. It must be noted, however, that these dataloggers do not have the capability of the PC-based systems in terms of on-line (i.e., real time) and off-line processing.

### **. Personal Computers**

A computer is used in two ways in plant monitoring, (i) as part of the DAS to receive, record, and/or transmit data over modem, and (ii) to retrieve data from the datalogger or another on-line computer. There are key considerations and trade-offs to be taken into account in the selection of a computer for monitoring purposes, like the capability to interface to an external device (modem, printer or plotter), the availability of an A/D slot card in the computer and the capacity of the computer's hard disk.

### **. Signal Conditioning Devices**

The signal conditioning devices convert the sensor signal from one range to another, and dc to dc, or dc to digital signal. There are essentially two specific types of signal conditioning - the isolation amplifier which does both signal conversion and isolation of input from the output (i.e. galvanic isolation), and the voltage divider. In general, isolation amplifiers should be used for the measurement of : (i) High dc bus voltages (even when voltage dividers are used), currents and other parameters that require signal conditioning because of the DAS input limitations. Voltage dividers are often necessary before the isolation amplifiers, for example, stepping down from the 500 V DC level PV array and battery voltages, to the 10 V DC level. The voltage divider is

simply a two-resistor network. Two of the best sources of isolation amplifiers are Analog Devices (5B series) and Hartman & Braun.

### **. Solar Irradiance Sensors**

Both instantaneous and daily energy values are needed to evaluate the performance of PV systems. It is important, therefore, that sensors used for continuous measurements of solar irradiance outdoors give accurate readings and be constructed to withstand environments normally encountered. Two basic types of solar irradiance sensors are the thermopile and silicon based devices. The interest in Si cells as the transducers for solar intensity stems from their low cost, and for the PV application, the similarity in the response characteristics between sensor and the PV array. They are available on the commercial markets about 3 to 5 times cheaper than the thermopile devices. Thermopile-based pyranometers have been widely used for solar irradiance monitoring in the meteorological stations and for solar thermal research and application work for several decades, and their characteristics are well known. The popular ones now available are the  $2\pi$ ,  $160^\circ$  field of view instruments from Kipp and Zonen, Schenk and Eppley Laboratories. These sensors have been widely accepted throughout the world as the principal instruments for irradiance measurements, and they are traceable to the World Radiometric Reference (WRR) [12]. For these reasons, only thermopile sensors can be used for calibration of Si sensors [12]. Si-based sensors have been reported to be technically comparable to the thermopile sensors within the desirable accuracy [12].

### **. Power, Ampere-Hour and Energy Meters**

These devices have been used mainly for the monitoring of : (i) solar energy on the plane of the array and on a horizontal surface, (ii) PV energy output and (iii) inverter energy output. Power, ampere-hour and energy meters are actually sensors because they give certain values of output in real time. The power sensor has analog voltage and current multipliers resulting in the VI product which is power. Then an electronic (analog) integrating circuit operating on power as the input yields energy over a given

duration of time. The ampere-hour counting circuit functions in a similar manner, but it uses only the current as input. Many of the dataloggers and PC-based DAS have the capability to multiply two channels (VI) to calculate power and then to integrate the power profile to obtain the energy. The computer can also calculate Ah by integrating the current.

### **. Modems**

Users often need to send information to other computers via telephone or radio modems for quick assessment. The rate of transferring data is important, especially when making long-distance calls.

### **. Miscellaneous Hardware**

Other sensors used in PV plant monitoring are those for ambient and PV module temperatures and wind speed. These are standard off-the-shelf items with many sources. For temperature measurements PT 100 and 105T thermocouple probes have become standard in many PV plants; wind speeds are normally measured using a A100R anemometer. Lightning overvoltage protection devices constitute another hardware items to be considered in any monitoring .

## **3.6 Experimental Procedure**

### **3.6.1 The PV Power Plant Characterisation**

#### **3.6.1.1 PV Power Plant Description**

For the purposes of these studies a stand alone water pumping system with a nominal capacity of 848  $W_p$  was installed outdoors at the Campus of the Eduardo Mondlane University, in Maputo, Mozambique. The system has been designed having in mind that it should provide drinking water to a community of 250 people. See appendix D for the methodology of designing a PV water pumping system. According to the recommendations of the World Health Organisation, a minimum of 40 litres per person and per day is required in rural areas, for drinking, hygiene and cooking. Thus, such a

system should supply an average of 10 cubic metres per day. The system comprises the following major subsystems:

- . Solar array with 16 solar modules built together to form a self-containing DC power generating system;
- . DC-AC inverter;
- . Submersible motor/pump unit.

For a detailed description of the main plant's components see appendix E, which is based on references [26-29]. Figure 3.5 shows a schematic diagram of the referred experimental set-up, and Figure 3.6 a photo of that scheme. In Figures 3.7 and 3.8 some components of the plant are presented.

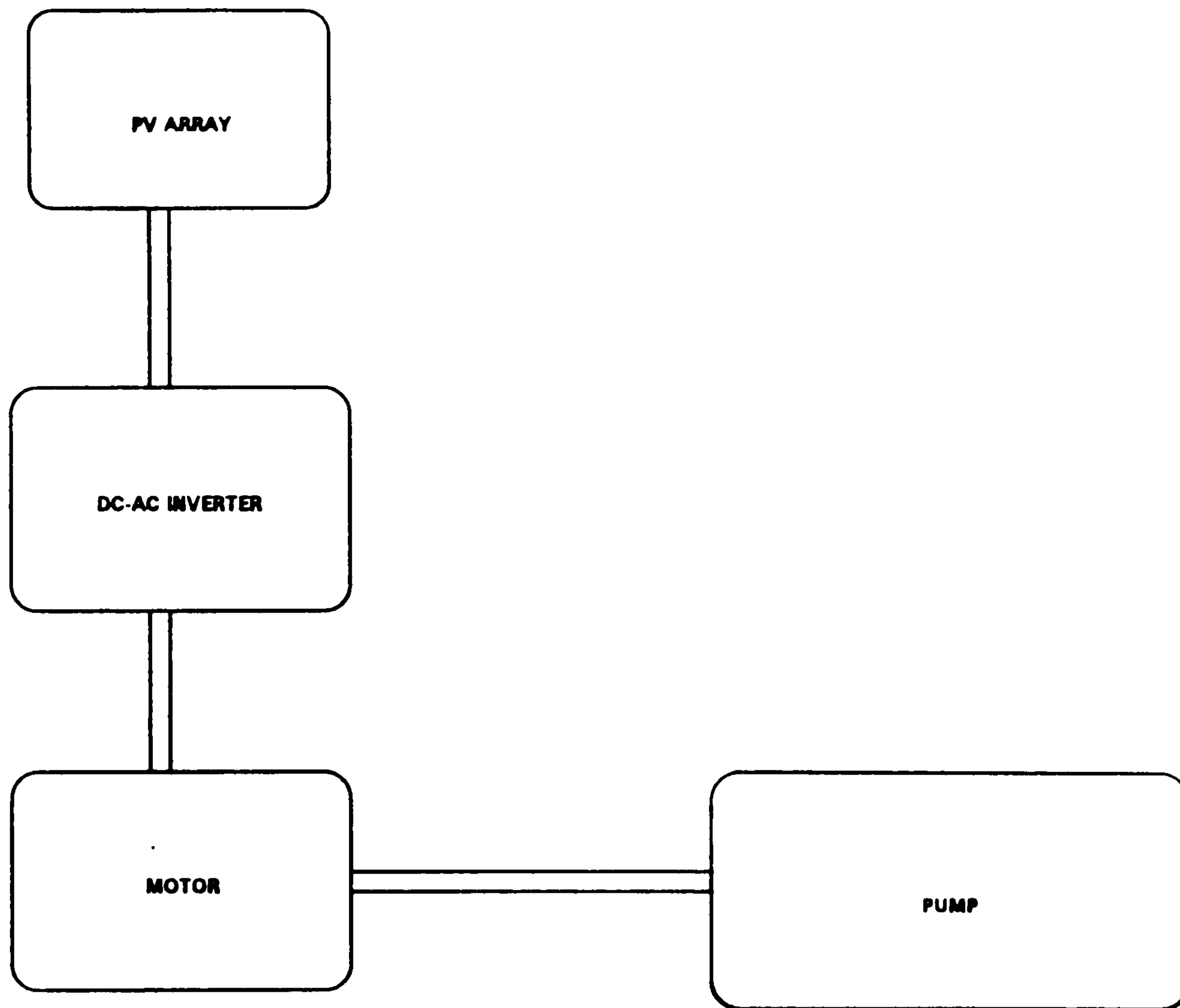

**Figure 3.5: The schematic diagram of the experimental set-up of the Eduardo Mondlane University.**

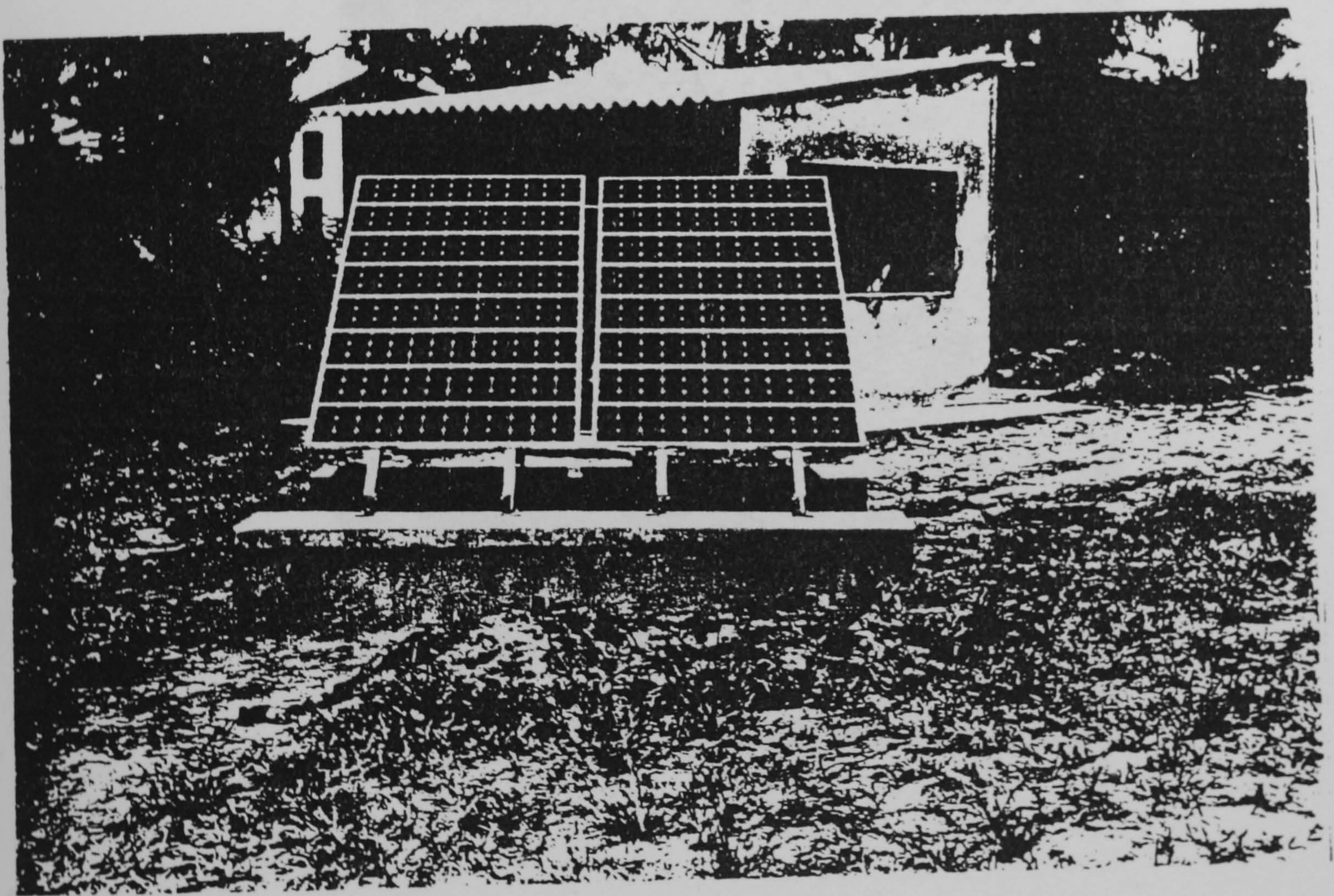

Figure 3.6 A photo of the experimental set-up of the Eduardo Mondlane University.



Figure 3.7: Components of the power plant (the Grundfos inverter SA 1500).

### 3.4.1.2 Monitoring System Components

The parameters monitored during the project were water level, water temperature, water depth, water velocity, water flow, water quality, and water quantity. The monitoring system was designed to collect and store data from these parameters. The data was then processed and analyzed to provide a comprehensive overview of the water plant's performance.

The data acquisition system was designed to collect data from the sensors and store it in a database.

The monitoring system was designed to provide a comprehensive overview of the water plant's performance.

Figure 3.8 shows a schematic of the monitoring system. The system consists of a data acquisition system, a monitoring system, and a data storage system.

The data acquisition system consists of a computer and a data acquisition card. The monitoring system consists of a computer and a monitoring software. The data storage system consists of a database.

The monitoring system was designed to provide a comprehensive overview of the water plant's performance. The data was collected from the sensors and stored in a database. The monitoring software was used to analyze the data and provide a comprehensive overview of the water plant's performance.

The data was collected from the sensors and stored in a database. The monitoring software was used to analyze the data and provide a comprehensive overview of the water plant's performance. The data was then processed and analyzed to provide a comprehensive overview of the water plant's performance.

The data acquisition system was designed to collect data from the sensors and store it in a database.

The monitoring system was designed to provide a comprehensive overview of the water plant's performance.

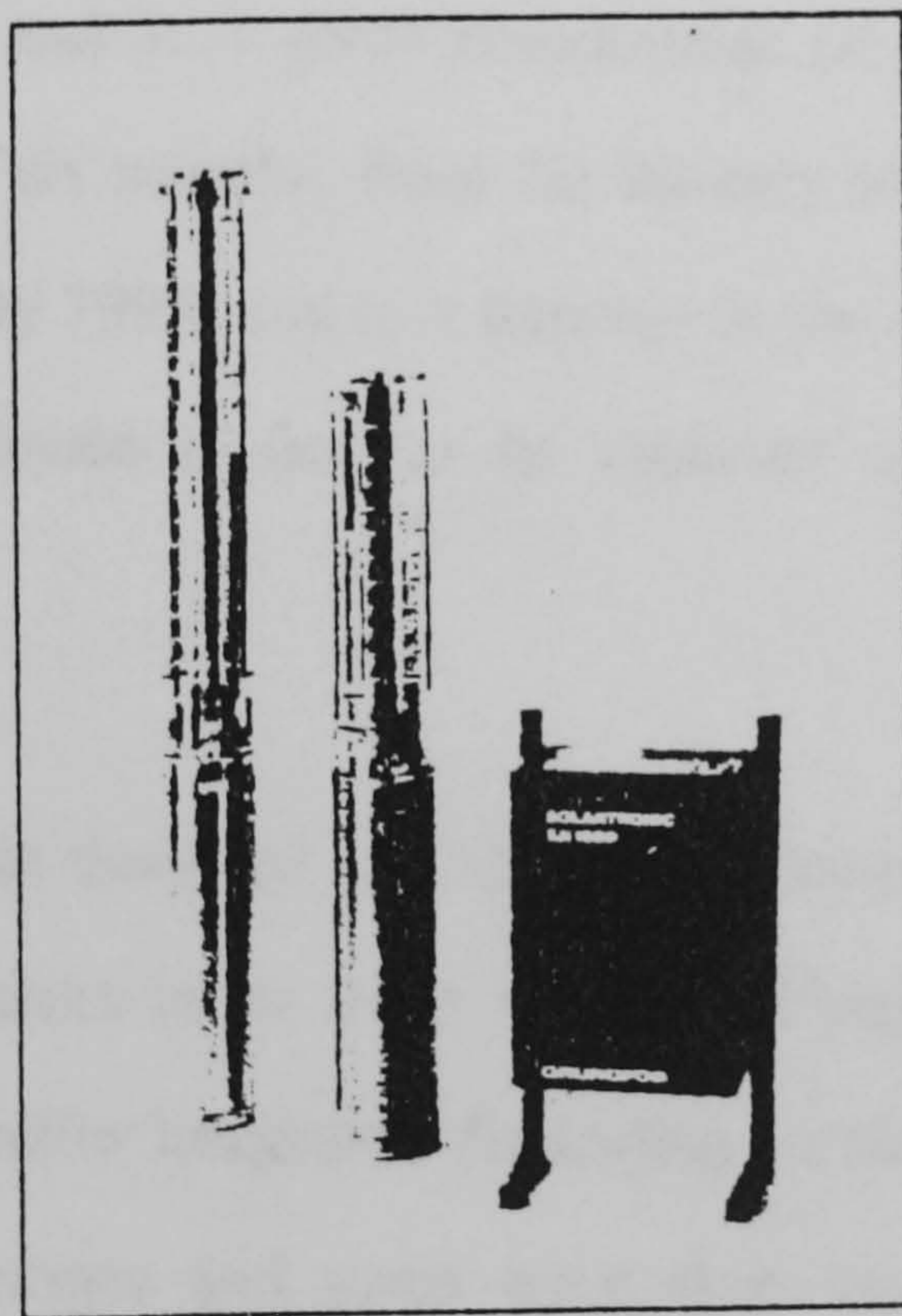

Grundfos (Denmark)

Figure 3.8: Components of the power plant (the submersible Grundfos pump).



### **3.6.1.2 Monitoring System Description**

The parameters monitored during the research work performed are as follows: (i) solar irradiance in the horizontal surface; (ii) solar irradiance in the plane of the array; (iii) array output DC current; (iv) array output DC voltage; (v) ambient air temperature; (vi) modules temperature; (vii) wind speed; (viii) inverter output AC power; and (ix) water flow. The monitoring system comprised the following main components:

- . The data acquisition system (of type datalogger);
- . The sensors and signal conditioning devices.

Figure 3.9 shows a schematic diagram of the plant with the associated monitoring system and Figures 3.10 and 3.11 some components of the monitoring system. The monitoring period was of six months, from 1st January to 30th June 1995. The work has been interrupted in July 1995, due to a damage in the AC powermeter caused by a lightning strike. This device is due to be replaced and the monitoring will be continued.

The monitoring system was designed so that every 5 seconds the datalogger recorded data measured by the sensors in its input memory. These data were then internally processed, i.e. averaged and/or integrated depending on the cases, in time intervals  $\Delta t_i$  of one hour. Hourly averages and sums were then saved in the datalogger final memory, which was linked to an extended external solid state storage module, ready to be transferred to a PC for off-site analysis. Some data were collected through direct readings. In the following sections details about the monitoring hardware will be provided.

#### **. The Data Acquisition System**

A datalogger of type Campbell Scientific 21X [30] was used for data acquisition and preliminary treatment. It encompassed 16 single-ended channels, equivalent to 8

differential channels, expandable to 192 channels by means of a multiplexer. An external solid state storage module of type SM 716, with a capability to store 716,000 readings, was coupled to the datalogger. The software PC-208 was used in association with the logger both for programming using a PC as well as for on-line data monitoring and transfer of data to the PC.

### . Sensors and Signal Conditioning Devices

The main characteristics of the sensors and signal conditioning devices used are presented in table 3.3.

Table 3.3 : Main characteristics of the sensors and signal conditioning devices used, from sources [31-36].

Type of Measurement	Type of Measuring Device	Accuracy
Solar irradiance	Pyranometer Campbell Scientific SP1110	3.0%
Temperature	Campbell Scientific Thermocouple Probe 105T	0.5%
Wind speed	Campbell Scientific Anemometer A100R	1.0%
DC current	Shunt with isolation Analog Devices of type 5B30-03	0.05%
DC voltage	Resistance bridge with isolation Analog Devices of type 5B31-03	0.05%
AC inverter output	Schalenberger powermeter	2.0%
Pump flow	Woltman counter WP-XC	3.0%

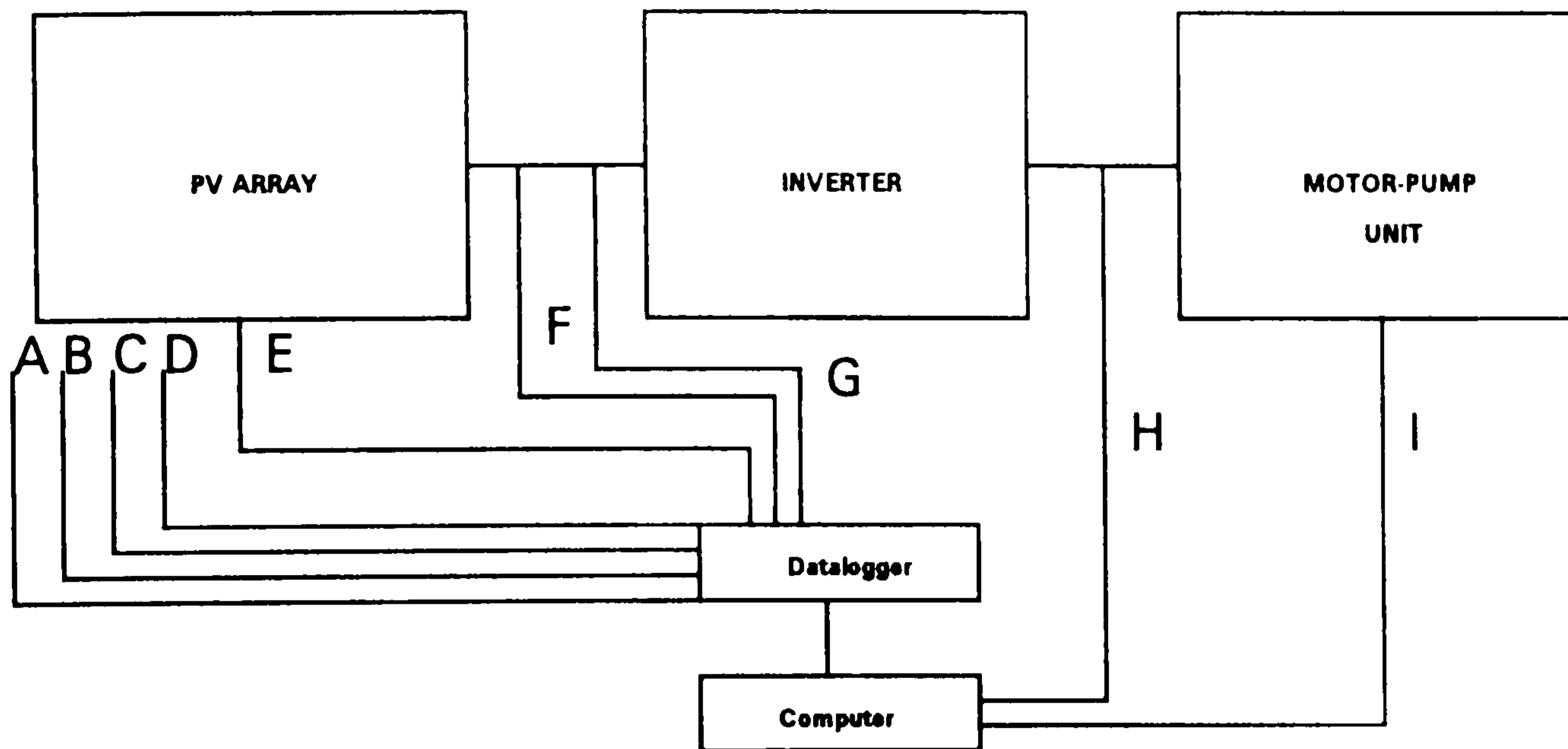

**Legend:**

Transducers of:

A - Solar irradiance on horizontal surface

B - Solar irradiance on array plane

C - Ambient temperature

D - Wind speed

E - Module/cell temperature

F - PV array voltage

G - PV array current

H - AC inverter output

I - Pump flow

Figure 3.9: Schematic of the power plant with the associated monitoring system.

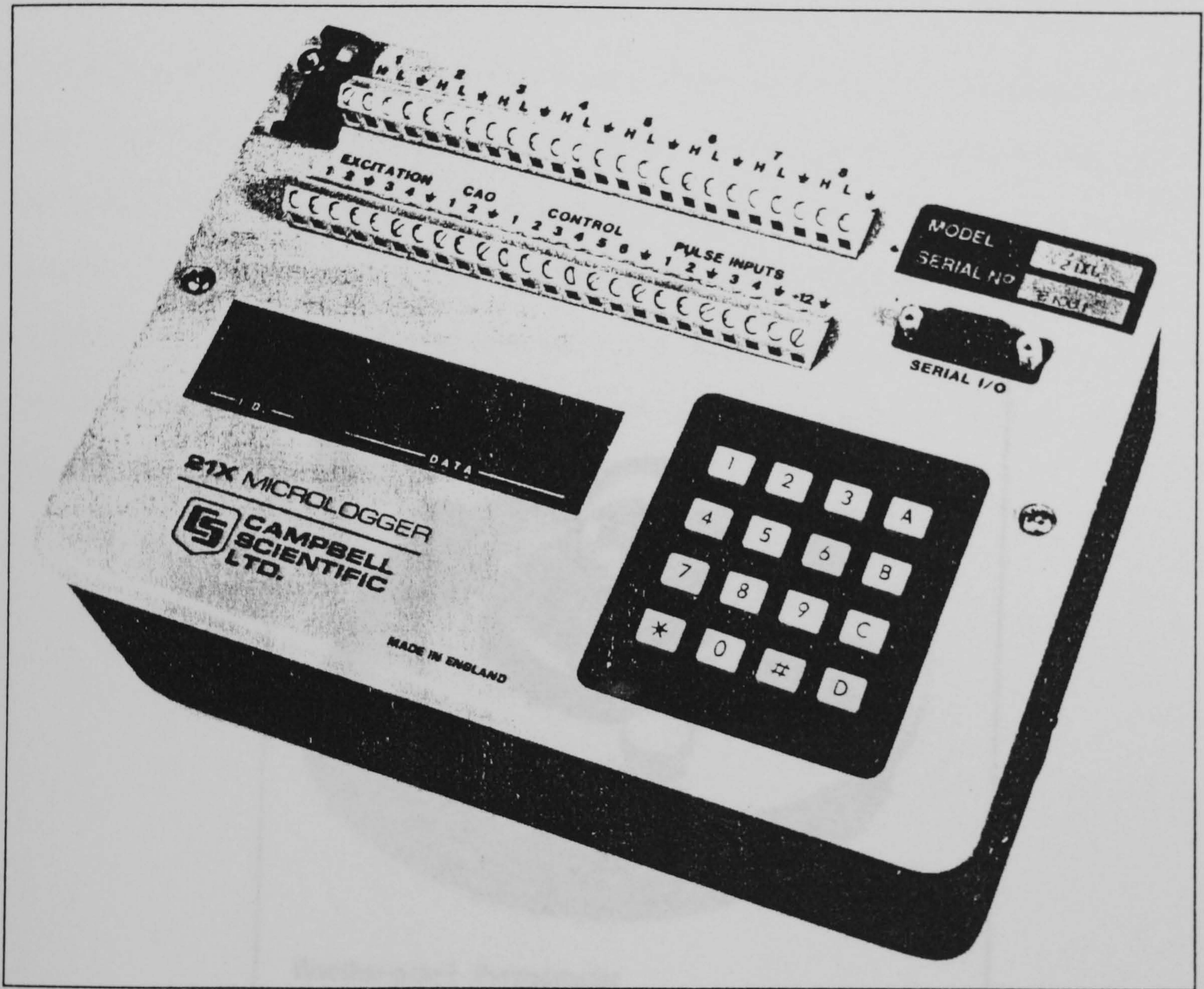
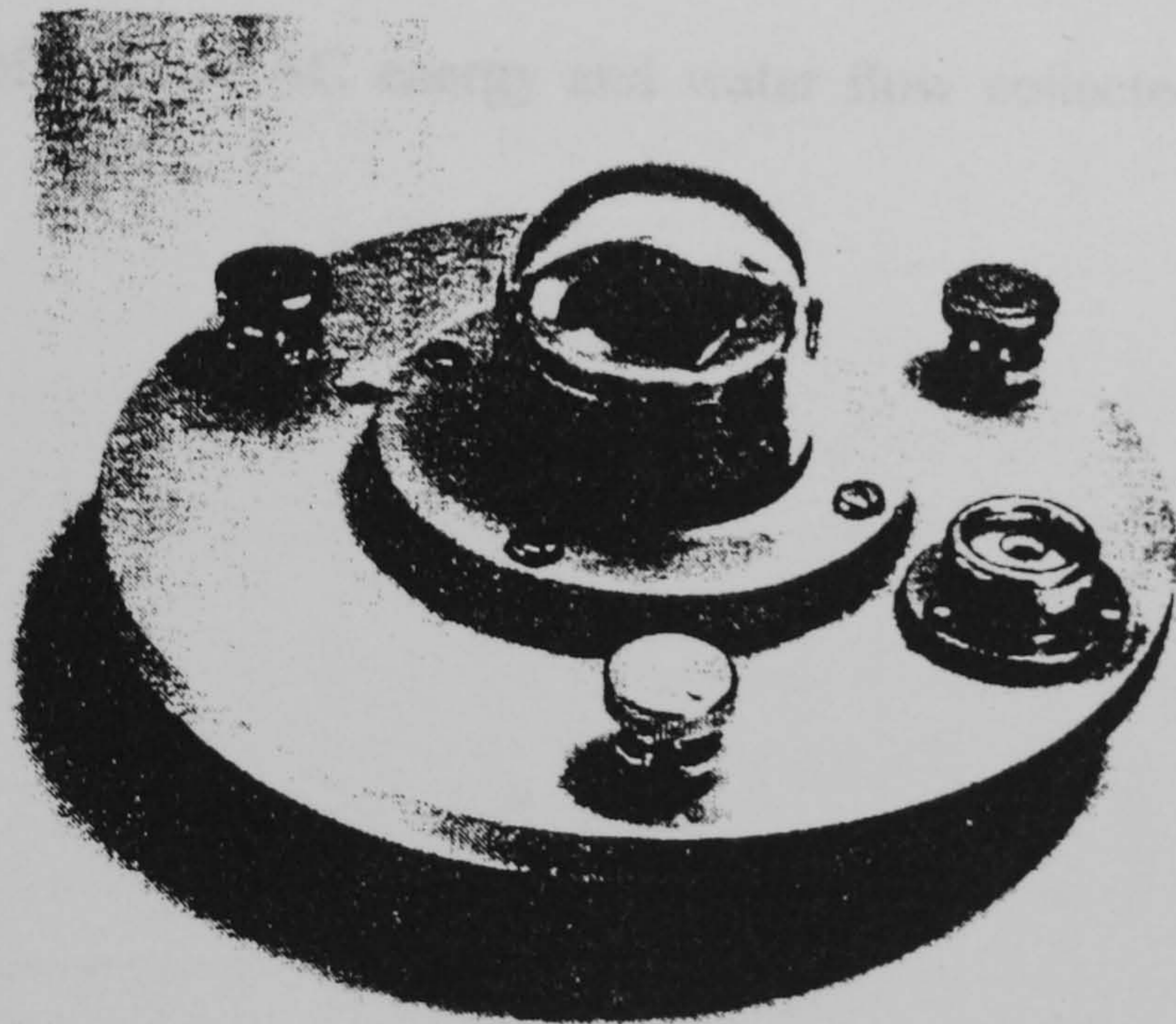

Figure 3.10: Components of the monitoring system (the datalogger 21X).

### 3.7 Monitoring Results

The monitoring activity was undertaken from the 1st January up to 31st June 1995. The datalogger Campbell 21A enabled us to record every five seconds instantaneous data measured by sensors of horizontal irradiance, global irradiance, ambient air temperature, module temperature, wind speed, array voltage, array current and array power (the product of array voltage and array current). Every five seconds data were internally processed by the datalogger to give us wind speed hourly averages. The data were internally averaged in such a way that the total hourly data and the hour of the measurement were indicated. Apart from the hourly readings were made for total daily values of AC energy from the inverter and of water flow from the face hole in the same period. The errors in the measurements here performed are as indicated in table 3.3. In table 3.4 data recorded by the datalogger in 5th May 1995 are presented, to serve as an illustration for the data acquisition format. Table 3.5 presents an example of the data recorded for the data acquisition format.



**Weather-proof Pyranometer**

Figure 3.11: Components of the monitoring system (A radiation sensor).

### **3.7 Monitoring Results**

The monitoring activity was undertaken from the 1st January up to 30th June 1995. The datalogger Campbell Scientific 21X enabled to record every five seconds instantaneous data measured by sensors of horizontal irradiance, planar irradiance, ambient air temperature, modules temperature, wind speed, array voltage, array current and array power (as a product of array voltage and array current). Every hour these data were internally processed by the datalogger in order to obtain their hourly averages. The data were internally organised in such a way that the year, the Julian day and the hour of the measurement were indicated. Apart from this, direct readings were made for total daily values of AC energy from the inverter and of water flow from the bore hole, in the same period. The errors in the measurements here performed are as indicated in table 3.3. In table 3.4 data recorded by the datalogger in 5th May 1995 are presented, to serve as an illustration for the data acquisition format. Table 3.5 presents an example of data of AC energy and water flow collected through direct readings.

Table 3.4: Data measured in 5th May 1995.

Year	Julian Day	Hours	Horizontal Radiation (W/m <sup>2</sup> )	Planar Radiation (W/m <sup>2</sup> )	Ambient Temperature (°C)	Modules Temperature (°C)	Array Voltage (V)	Array Current (A)	Array Energy (kWh)
1995	125	5.00	0.384	0.415	17.55	16.46	0.698	0.006	0.000
1995	125	6.00	0.393	0.413	17.30	16.25	2.522	0.006	0.000
1995	125	7.00	24.32	35.77	17.32	16.60	84.50	0.129	0.013
1995	125	8.00	170.1	249.7	20.19	22.51	116.5	1.513	0.182
1995	125	9.00	358.5	514.3	24.01	31.79	132.2	2.873	0.380
1995	125	10.00	527.6	724.0	27.16	41.37	124.5	4.076	0.506
1995	125	11.00	637.3	864.0	27.93	48.23	118.8	4.944	0.587
1995	125	12.00	689.3	927.0	28.06	50.04	118.4	5.237	0.620
1995	125	13.00	675.8	918.0	27.35	48.13	119.0	5.137	0.611
1995	125	14.00	598.6	835.0	27.36	45.92	121.3	4.686	0.568
1995	125	15.00	461.9	675.7	26.65	42.17	125.6	3.722	0.465
1995	125	16.00	279.2	443.0	25.36	35.57	129.8	2.341	0.305
1995	125	17.00	66.38	117.4	23.69	26.64	113.9	0.479	0.055
1995	125	18.00	3.186	3.799	22.52	21.07	37.86	0.021	0.001
1995	125	19.00	0.382	0.435	22.33	20.62	0.772	0.006	0.000

Table 3.5: Data collected directly from AC energy and water flow meters in May 1995.

Month/Year	Day	AC Energy [kWh/Day]	Water Flow [m <sup>3</sup> /Day]
May/1995	1	3.9	11.5
May/1995	2	3.7	11.1
May/1995	3	2.3	05.4
May/1995	4	3.2	08.2
May/1995	5	4.0	12.7
May/1995	6	4.0	12.2
May/1995	7	3.0	07.7
May/1995	8	3.0	07.3
May/1995	9	3.0	08.8
May/1995	10	1.3	01.1
May/1995	11	4.0	12.1
May/1995	12	4.2	12.9
May/1995	13	3.8	11.4
May/1995	14	0.0	00.0
May/1995	15	5.5	14.1
May/1995	16	3.9	12.3
May/1995	17	2.3	04.1
May/1995	18	3.8	11.8
May/1995	19	4.0	11.8
May/1995	20	3.8	11.8
May/1995	21	3.6	11.4
May/1995	22	1.2	01.6
May/1995	23	0.0	00.0
May/1995	24	3.6	09.6
May/1995	25	3.9	12.4
May/1995	26	3.9	13.2
May/1995	27	3.8	12.7
May/1995	28	0.0	00.0
May/1995	29	5.0	12.5
May/1995	30	3.9	12.6
May/1995	31	2.3	05.2



All recorded data have been transferred to a PC for analysis. The spreadsheet Excel 4 for Windows has been used to import data, as well as for analysis and graphical presentation. The next subsections give an account on the different analyses performed.

### **3.7.1 Solar Radiation and Temperature Behaviour**

The solar radiation and the temperature are the major parameters affecting the performance of any system whose operation is based on solar cells. Thus, it is important to understand how these parameters behave in local conditions. Figure 3.12 presents the behaviour of solar radiation both in the horizontal (horizontal radiation) and in the plane of the array (planar radiation) surface in 6th January 1995. The useful period of the day considered in this analysis is from 5 a.m. up to 7 p.m.. Based on hourly values of radiation, daily values were computed and then monthly average values were calculated. Figure 3.13 presents average monthly values of radiation from January to June 1995. Similar analysis were performed for temperature behaviour, as presented in Figures 3.14 and 3.15.

Behaviour of Solar Radiation in 06/01/95

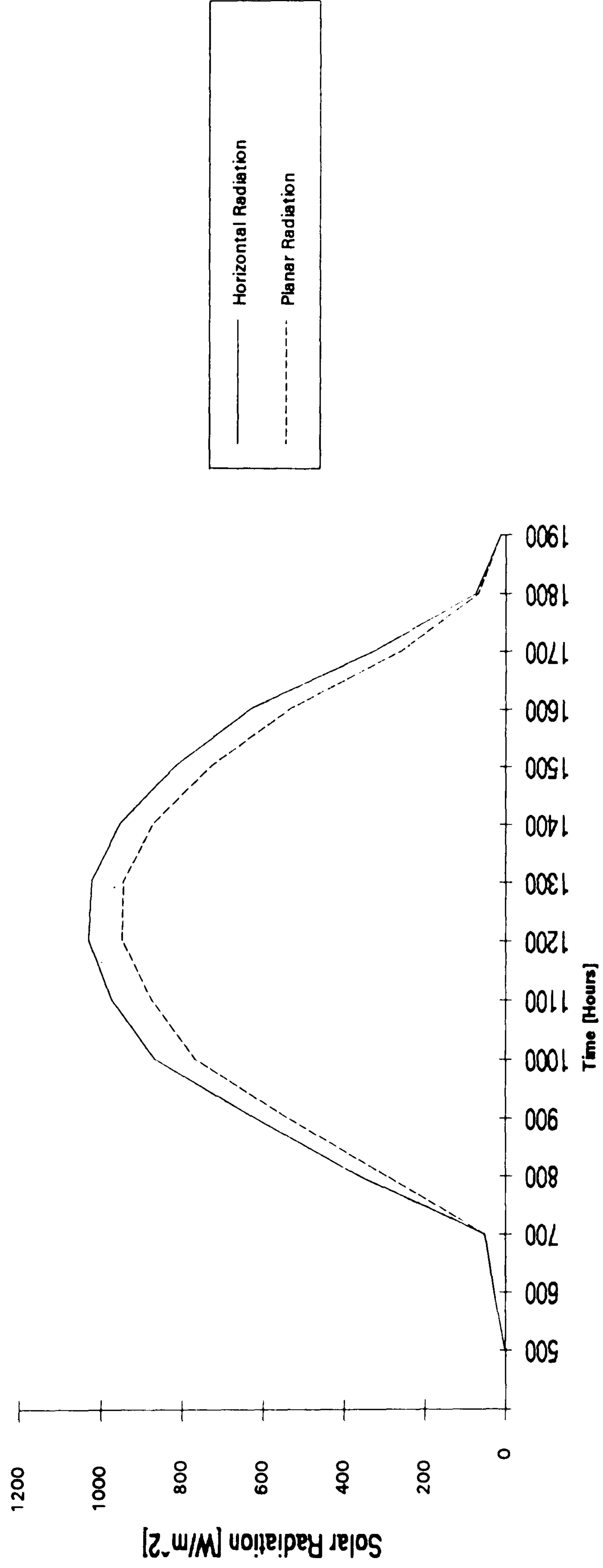

Figure 3.12: Behaviour of solar radiation in the horizontal and in the plane of the array surface in 6th January 1995.

### Behaviour of Solar Radiation from January to June 1995

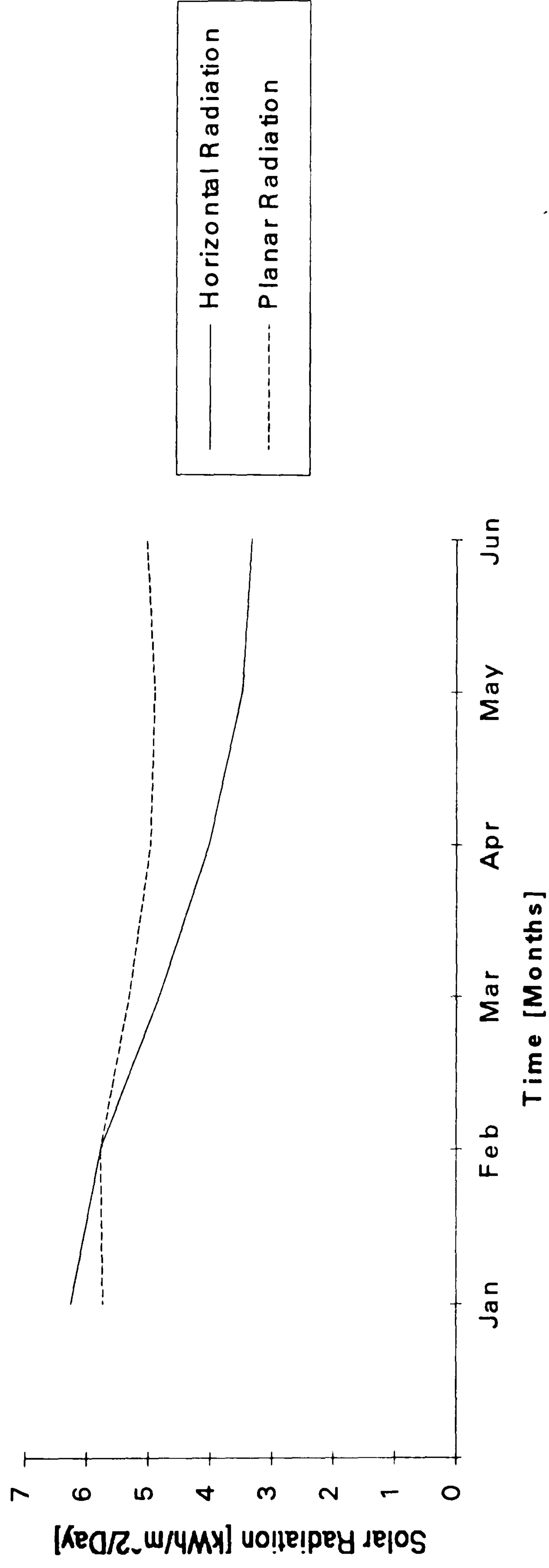

Figure 3.13: Average monthly values of radiation from January to June 1995.

### Behaviour of Temperature in 06/01/95

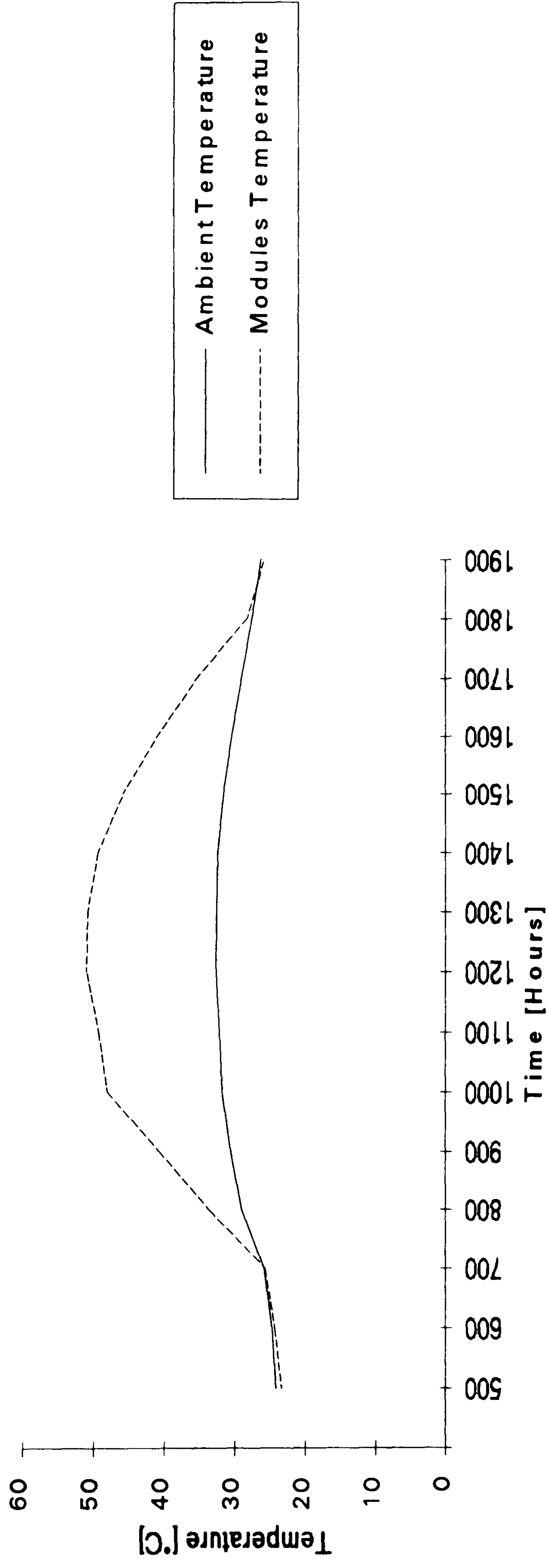

Figure 3.14: Behaviour of ambient temperature and of PV modules temperature in 6th January 1995.

### Behaviour of Temperature from January to June 1995

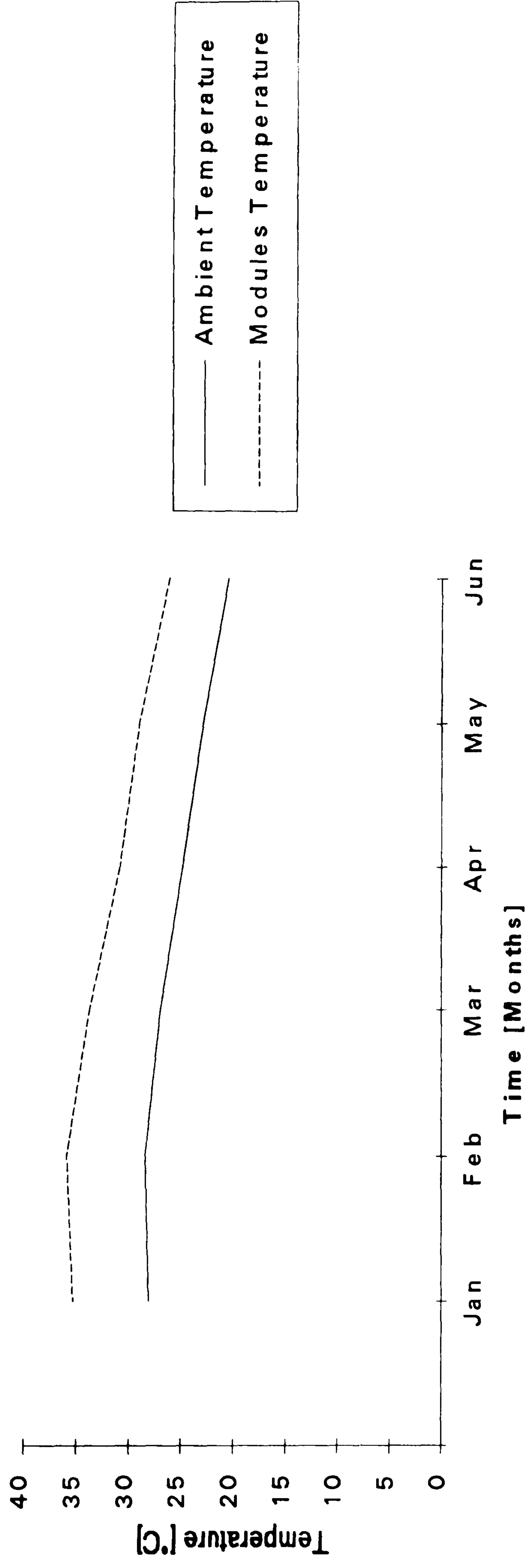

Figure 3.15: Average monthly values of temperature from January to June 1995.

### 3.7.2 Determination of the Conversion Efficiencies of the PV Plant

Based on expressions 3.1 and the results of measurements the conversion efficiencies of the major components of the plant as well as its global efficiency were determined. Figure 3.16 represents the conversion efficiencies of the array in 5th June 1995, while table 3.6 represents the monthly averages of the efficiencies of the plant's components, including the global efficiency. Figure 3.17 is a graphical representation of table 3.6.

Table 3.6: Monthly averages of the plant's components efficiencies.

<b>Months</b>	<b><math>\eta_{array}</math> [%]</b>	<b><math>\eta_{inverter}</math> [%]</b>	<b><math>\eta_{motor/pump}</math> [%]</b>	<b><math>\eta_{global}</math> [%]</b>
Jan	11.4	94	34	3.6
Feb	11.3	94	34	3.7
Mar	11.3	94	33	3.5
Apr	11.5	93	32	3.4
May	11.6	93	32	3.4
Jun	11.8	93	34	3.8
<b>Average</b>	<b>11.5</b>	<b>94</b>	<b>33</b>	<b>3.6</b>

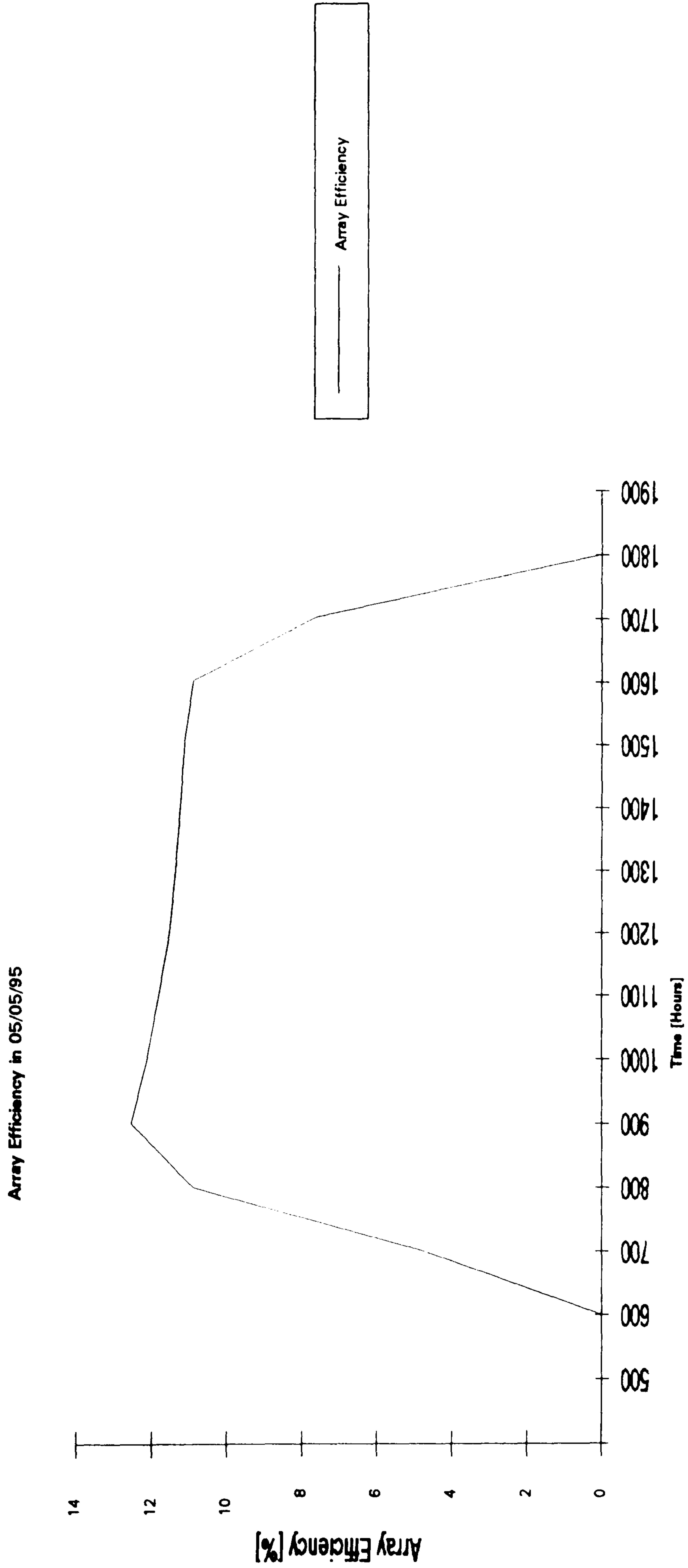

Figure 3.16: Conversion efficiencies of the array in 5th June 1995.

## Conversion Efficiencies of the Plant from January to June 1995

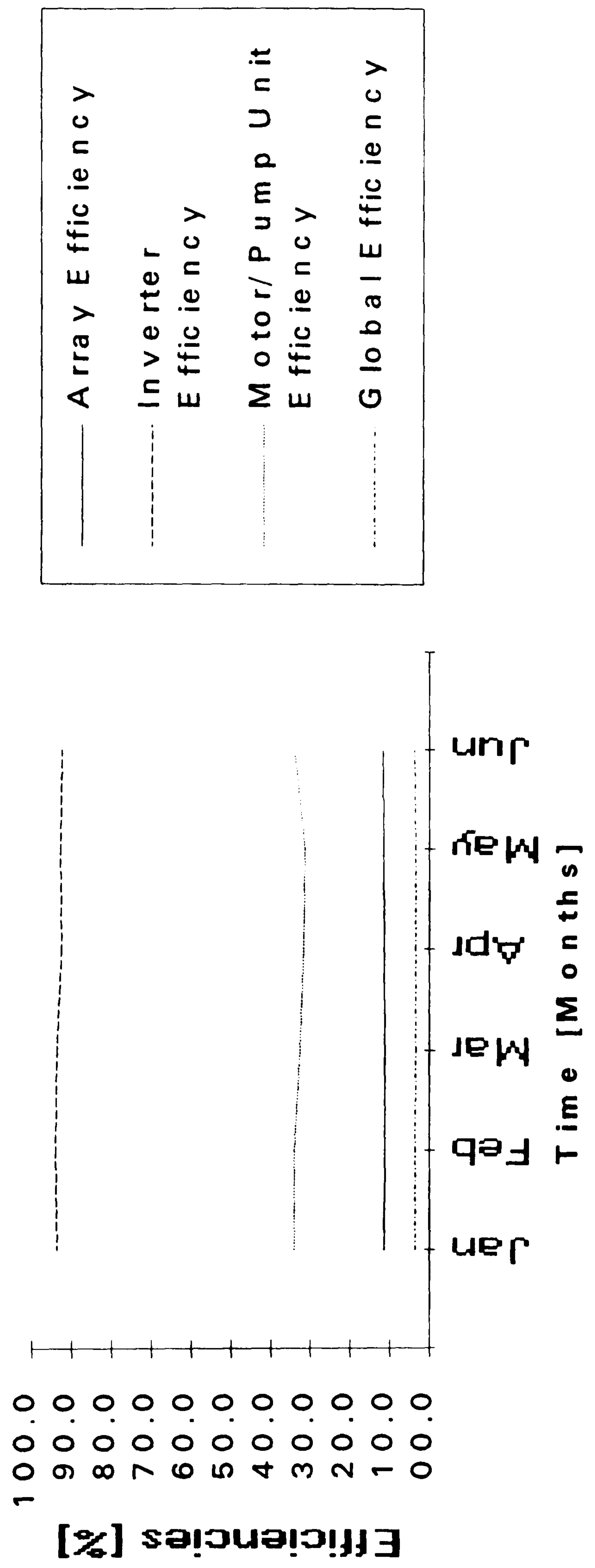

Figure 3.17: Monthly averages of conversion efficiencies of the plant.



According to the theory of errors propagation, and taking into account expressions (3.1), the relative errors in the determination of the major plant's components efficiencies are as follows:

**. PV Array:**

$$E_r = \sqrt{\left(\frac{\Delta I_{dc}}{I_{dc}}\right)^2 + \left(\frac{\Delta V_{dc}}{V_{dc}}\right)^2 + \left(\frac{\Delta E_e}{E_e}\right)^2} = \sqrt{(0.0005)^2 + (0.0005)^2 + (0.03)^2} = 3.0\%$$

**. Inverter:**

$$E_r = \sqrt{\left(\frac{\Delta P_{ac}}{P_{ac}}\right)^2 + \left(\frac{\Delta I_{dc}}{I_{dc}}\right)^2 + \left(\frac{\Delta V_{dc}}{V_{dc}}\right)^2} = \sqrt{(0.02)^2 + (0.0005)^2 + (0.0005)^2} = 2.0\%$$

**. Motor/Pump Unit**

$$E_r = \sqrt{\left(\frac{\Delta m}{m}\right)^2 + \left(\frac{\Delta h}{h}\right)^2 + \left(\frac{\Delta P_{ac}}{P_{ac}}\right)^2} = \sqrt{(0.03)^2 + (0.02)^2 + (0.02)^2} = 4.1\%$$

**. Global System**

$$E_r = \sqrt{\left(\frac{\Delta \eta_{array}}{\eta_{array}}\right)^2 + \left(\frac{\Delta \eta_{inverter}}{\eta_{inverter}}\right)^2 + \left(\frac{\Delta \eta_{motor/pump}}{\eta_{motor/pump}}\right)^2} = \sqrt{(0.03)^2 + (0.02)^2 + (0.041)^2}$$

=5.5%

Considering the relative errors computed here and the values of efficiencies presented on table 3.6, the average efficiencies of the plant during the period of analysis can be indicated as:

- .  $\eta_{array}=(11.5\pm 0.3 )\%$ ;
- .  $\eta_{inverter}=(94\pm 2)\%$ ;
- .  $\eta_{motor/pump}=(33\pm 1 )\%$ ;
- .  $\eta_{global}=(3.6\pm 0.2)\%$ .

The data used to perform the calculations of errors presented above were taken from the table 3.3. Concerning the height  $h$  from the dynamic water level up to the top of the tank, an error of 1.0 metre has been considered in order to take into account the level fluctuations.

### **3.7.3 Testing of a Simplified Model for Describing Photovoltaic Array Output**

Here three important situations were compared, using data of several days obtained during monitoring: (i) the array energy output based on the simplified model (which uses experimental data of solar radiation and of temperature); (ii) the array energy output based on the simplified model, but neglecting the effect of the temperature and (iii) the array energy output based on purely experimental data. Figure 3.18 represents plots of such situations for 5th May 1995 and Figure 3.19 for the period January 1995.

### Array Energy Output in 06/01/95

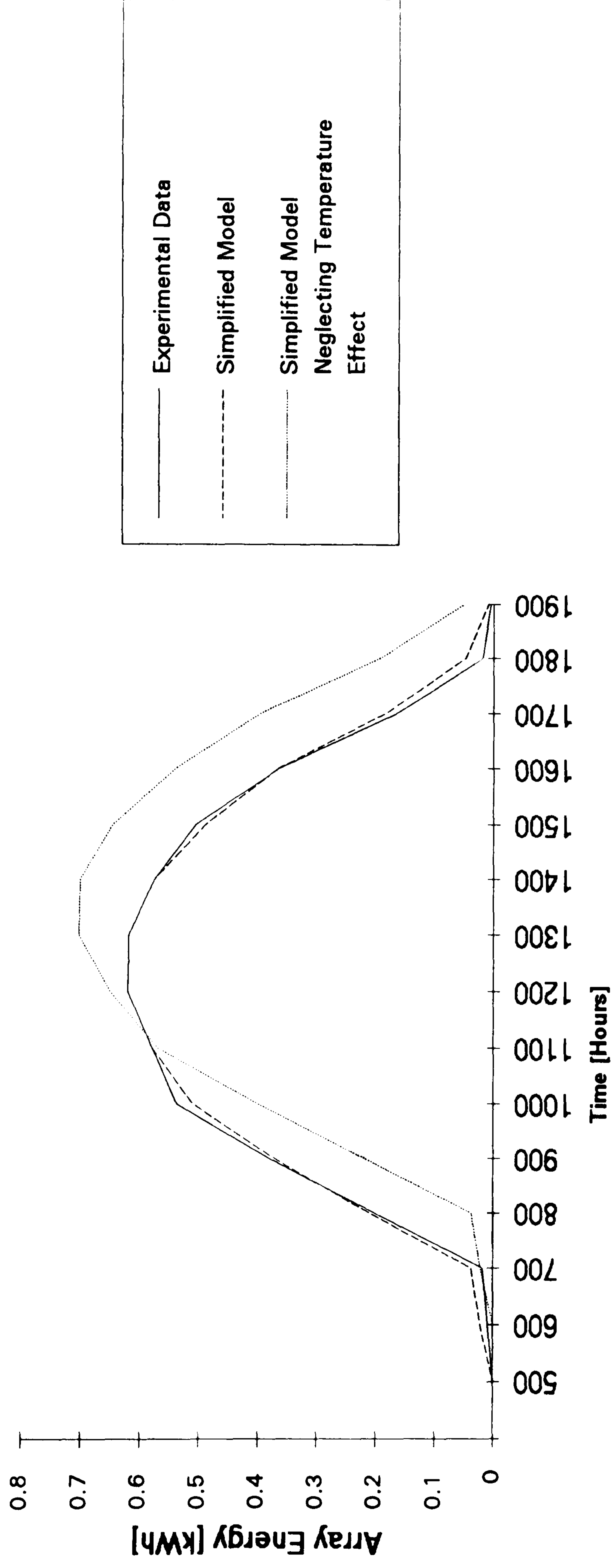

Figure 3.18: Array output energy in 6th January 1995.

### Array Output Energy in January 1995

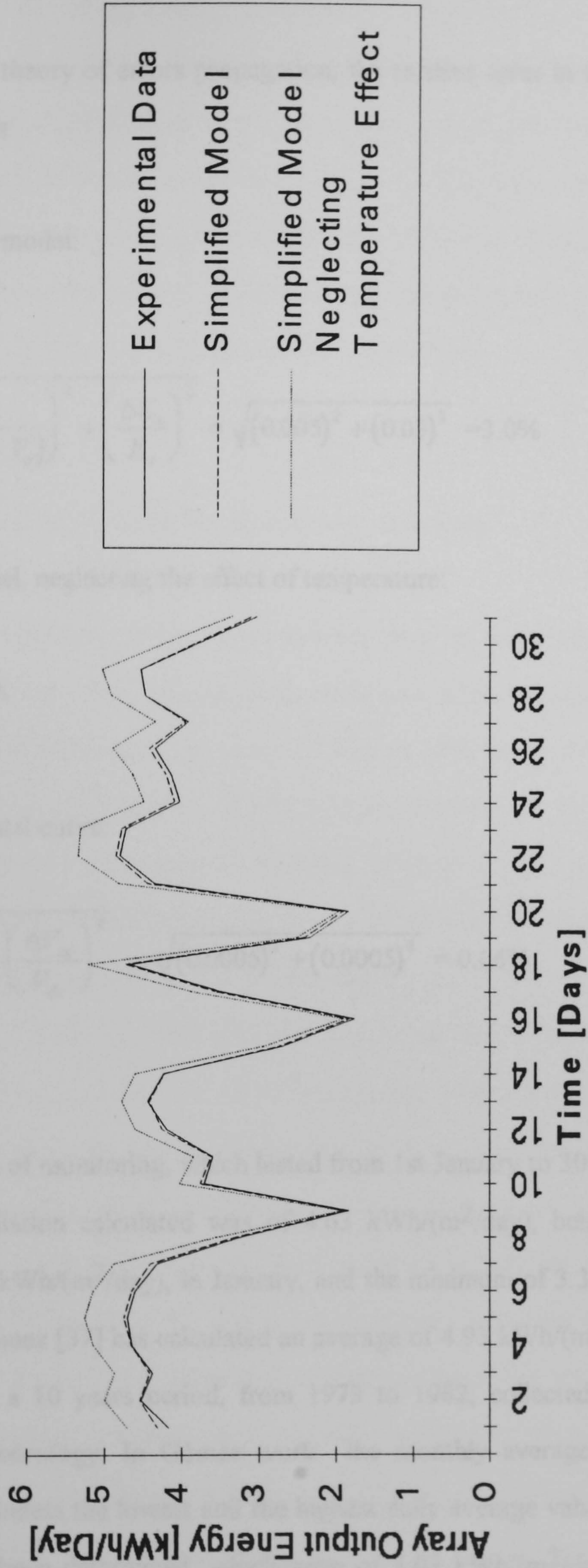

Figure 3.19: Array output energy during January 1995.

According to the theory of errors propagation, the relative error in these calculations can be indicated as:

For the simplified model:

$$E_r = \sqrt{\left(\frac{\beta\Delta T}{1-\beta(T-T_o)}\right)^2 + \left(\frac{\Delta E_e}{E_e}\right)^2} = \sqrt{(0.005)^2 + (0.03)^2} = 3.0\%$$

For the same model, neglecting the effect of temperature:

$$E_r = \frac{\Delta E_e}{E_e} = 3.0\%;$$

For the experimental curve:

$$E_r = \sqrt{\left(\frac{\Delta I_{dc}}{I_{dc}}\right)^2 + \left(\frac{\Delta V_{dc}}{V_{dc}}\right)^2} = \sqrt{(0.0005)^2 + (0.0005)^2} = 0.06\%$$

### 3.8 Conclusions

During the period of monitoring, which lasted from 1st January to 30th June 1995, the average solar radiation calculated was of 4.63 kWh/(m<sup>2</sup>/day), being the maximum observed of 6.27 kWh/(m<sup>2</sup>/day), in January, and the minimum of 3.35 kWh/(m<sup>2</sup>/day), in June. U. M. Gómez [37] has calculated an average of 4.93 kWh/(m<sup>2</sup>/day) using data corresponding to a 10 years period, from 1973 to 1982, collected by the National Institute for Meteorology. In Gómez work the monthly averages have not been calculated; nevertheless the lowest and the highest daily average values of radiation in that period have been determined, which were of 3.03 kWh/(m<sup>2</sup>/day) (in Julian day

183, or the second day of July) and 7.55 kWh/(m<sup>2</sup>/day) (in Julian day 364, or the 29th day of December), respectively. Thus there is a good agreement between the results of the two studies; the slight differences are inside the limits of solar radiation variability. From these data it is to conclude that solar radiation in this region is high, suitable for the deployment of solar technologies (see Figures 3.12 and 3.13). In fact, according to [38-39] a minimum average of 2.8 kWh/(m<sup>2</sup>/day) in the month with the lowest average is required for an effective deployment of these technologies.

The performance of the plant can be characterised as follows:

The conversion efficiency of the array increases early morning rapidly, in about one hour (see Figure 3.16), from zero up to its maximum, of about 12%. Then there is a slow decrease of the efficiency from about 12% up to 11% during the most useful part of the day. This is probably due to the effect of temperature. At the end of the day a very rapid decrease of the efficiency is observed, down to zero when it becomes dark. The average efficiency registered during the period of analysis was of about 11.5%. Silicon mono-crystalline cell modules had during the first half of this decade efficiencies around 14% to 16% [38-39]. The value here found of (11.5±0.3)% determined here is quite good, as it takes into account losses in the wiring system of the array and the fact that days with very low level of sunshine contribute with a nearly nil efficiency. The value of efficiency starts and ends at nil, as in the transition between day and night there are levels of radiation which are measured by the pyranometer sensors but their intensity is not enough to stimulate the production of electricity in the array. Thus, there are situations where the output electricity is practically nil, although the input solar radiation is different from zero. Obviously, when it is completely dark there is no sense to consider efficiencies, as both the input solar radiation and the output electricity are zero.

. According to manufacturer's specifications the Grundfos inverter Solartronic SA 1500, which contains a power electronic interface unit, has a nominal instantaneous efficiency of 96%, a maximum of 97% and a minimum of 95%. The average efficiency of the inverter registered during the period of monitoring, of  $(94\pm 2)\%$ , is quite high (see Figure 3.17), as in a such long period it is to consider time intervals in which there is no sunshine or the sunshine is not enough to activate the tracking and the stepping up capabilities of the PEI unit device. Previous experience indicates that the loss of a PV plant between the array and the remainder of the system, without a PEI unit, is of at least 17%. Thus a gain of at least 9% is achieved with the use of a PEI unit device.

. The motor/pump unit has performed with an average efficiency of about  $(33\pm 1)\%$  in converting AC energy to hydraulic energy. A good motor/pump unit should have an efficiency of at least 30% or ideally more than 40% [39]. The value here determined is good. An important aspect to be taken into account is that losses in piping system of the plant contribute to reduce the efficiency of the motor/pump unit

. The  $(3.6\pm 0.2)\%$  average global efficiency reflects clearly the improvement in the system performance in the last few years, since in the 1980s the efficiency of a solar pumping system was typically about 2.0% [39]. With the use of the PEI unit there is a gain in global efficiency of about 0.4%.

. The simplified model describes the performance of the photovoltaic array in the local environment with a very good degree of accuracy (see Figures 3.18 and 3.19). From analysis of data referring to January (Figure 3.19), it has been concluded that the deviation between experimental data and those obtained using the simplified model was in average of 1.5%, and varying between 0.10% to 3.5%. This is in agreement with the results referred in [9]. If the effect of temperature is neglected, then the average deviation becomes 10%, varying from 4.0% to 13%. Thus the simplified model is a very good approximation to describe the performance of a PV array for most practical

purposes. It is important that both profiles of radiation and of temperature be considered in such cases.

This research work enabled the determination of important parameters for an effective use of photovoltaics. It is of extreme importance that it be continued in order to test a full model describing the performance of a water pumping system and also to test models for other enduses, like lighting, refrigeration and telecommunications.

### **References**

- [1] D. M. Divan and M. M. Hasan "Maximisation of Operating Efficiency of Solar Cells", *Energy Conversion*, Volume 17, 1977, Pages 183-188.
  
- [2] Ziyad Salameh and Daniel Taylor "Step-up Maximum Power Point Tracker for Photovoltaic Arrays", *Solar Energy*, Volume 44, 1990, Pages 57-61.
  
- [3] O. El. Safi, P. W. Robertson and R. Hill "The Development of a Power Electronic Interface to Produce a High Voltage DC Link from a Photovoltaic Array", *Proceedings of the 9th E. C. Photovoltaic Conference, Freiburg, September, 1989.*
  
- [4] O. El. Safi "The Use of Power Electronic Interface in the Efficacious Utilisation of Power in Photovoltaic Pumping Systems", Ph.D. Thesis, Newcastle Upon Tyne Polytechnic, Newcastle Upon Tyne, 1990.
  
- [5] R. Hanitsch and G. Duschl "Design and Test of a Three-Phase Sinusoidal Inverter with Maximum Power Point Control of the Voltage Source Inverter for Solar Pumps", *8th EC PVSEC, 1988, Pages 1135-1139.*



- [6] W. R. Evans "Control System Dynamics", McGraw Hill, New York, 1954.
- [7] D. A. Bradley "Power Electronics", Van Nostrand Reinhold (International), 1990.
- [8] B. W. Williams "Power Electronics: Devices, Drivers, Applications and Passive Components", Macmillan, 1992.
- [9] M. S. Imamura "A Simplified Method for Determining the Available Power and Energy of a Photovoltaic Array, in Photovoltaic System Technology: A European Handbook", Edited by M. S. Imamura, P. Helm and W. Palz, H. S. Stephens & Associates, 1992.
- [10] M. D. Siegel, S. A. Klein and W. A. Beckman "A Simplified Method for Estimating the Monthly-Average Performance of Photovoltaic Systems", Solar Energy, Volume 26, 1981, Pages 413-418.
- [11] D. L. Evans "Simplified Method for Predicting Photovoltaic Array Output", Solar Energy, Volume 27, 1981, Pages 555-560.
- [12] M. S. Imamura, P. Helm, W. Palz "Photovoltaic System Technology: A European Handbook", H. S. Stephens & Associates, 1992.
- [13] D. Kearney et al. "Status of the SEGS Plants", Proceedings of the 1991 ISES Solar World Congress, Volume 1, Part 1, Denver, CO, USA, August 1991.
- [14] M. S. Imamura "PV System Technology Development in the European Community", Proceedings of the Euroforum - New Energies Congress, Volume 1, Saarbrücken, FRG, October 1988.

- [15] W. Palz "The European Community R&D Programme on Photovoltaics", Proceedings of the 10th EC PVSEC, Lisbon, Portugal, April 1991, Pages 1369-1370.
- [16] Roy Barlow, Bernard McNelis and Anthony Derrick "Solar Pumping", Intermediate Technologies Publications and The World Bank, Washington, D.C., 1993.
- [17] B. McNelis and A. Derrick "Photovoltaic Water Pumping: Experience to 1988", Proceedings of the Euroforum New Energies Congress, Saarbrücken, F.R.G., 1988.
- [18] P. Fraenkel "Water Pumping Devices", IT Publications, 1986.
- [19] J. Kenna and W. Gillett "Solar Water Pumping: A Handbook", IT Publications, 1985.
- [20] R. Hill "Photovoltaics in Developing Countries", Proceedings of the 9th EC PVSEC, Freiburg, September 1989.
- [21] F. Lasnier and T. G. Ang "Photovoltaic Engineering Handbook", Adam Hilger, 1990.
- [22] Human Development Report, UNDP, 1994.
- [23] G. Blaesser and K. Krebs "Guidelines for the Assessment of PV Plants, Document A - Photovoltaic System Monitoring", JRC Publications SP-1.87.43, November 1988.
- [24] G. Blaesser, K. Krebs and M. R. Starr "Guidelines for the Assessment of PV Plants, Document B - Analysis and Presentation of Monitoring Data", JRC Publications SP-1.88.44, November 1988.

[25] G. Blaesser, K. Krebs and M. R. Starr "Guidelines for the Assessment of PV Plants, Document C - Initial and Periodic Tests on PV Plants", JRC Publications SP-1.88.45, November 1988.

[26] Installation Guide for the Siemens Solar Industries M55/M50/M65/M20/M45/M40/M35 Solar Electric Modules, Siemens Solar Industries, 1990.

[27] Grundfos Pump Catalogue: Pumps, Controls and Accessories, Grundfos, March 1993.

[28] Forjadora, E.E. "Projecto de Construção de um Tanque de Água para a Universidade Eduardo Mondlane", Maputo, Moçambique, 1992.

[29] Furo nº 8/RA2/92; Cliente: Universidade Eduardo Mondlane; Local: Polana Cimento, Geomoc, E.E., Maputo, Moçambique, 1992.

[30] 21X Micrologger Operator's Manual, Campbell Scientific, 1991.

[31] SP1110 Pyranometer Sensor, User Guide, Campbell Scientific, 1994.

[32] 105 Thermocouple Probe, User Guide, Campbell Scientific, 1990.

[33] A100 R Switching Anemometer, Instruction Manual, Campbell Scientific, 1992

[34] Hyperion Unit 1, Installation Manual, Hyperion, 1993.

[35] Measurement of Energy, Technical Manual, CEWE, 1991.

[36] PU 100, BPU100, Pulse Units, ABB, 1991.

[37] U. M. Gómez "Processamento de Dados de Radiação Solar, por Computador, para Aplicações Práticas", III Jornadas de Engenharia e Ciências de Moçambique", Maputo, Moçambique, 1988.

[38] Wim Hulscher and Peter Fraenkel "The Power Guide", IT Publications, 1994.

[39] Anthony Derrick, Catherine Francis and Varis Bokalders "Solar Photovoltaic Products: A Guide for Development Workers", IT Publications, 1991.

## **Chapter 4**

# **The Economics of the Power Plant**

#### **4.1 Introduction**

The last decade (the eighties) was characterised by the emergence of a significant number of experimental stations in photovoltaics, especially in Europe, Japan and North America. This has contributed to the solution of many technical problems associated with this technology. In this decade, increased attention is being paid to the economics, as the technology has entered the market. It has become apparent that, in spite of favourably low operating costs, the dissemination of photovoltaics is often hampered by their relatively high capital costs, which reduce the motivation of private investors or public decision-makers to act as pioneers in this area. On their way to market penetration, photovoltaic systems face severe competition from fossil fuel based energy supply systems. Nevertheless, there are many enduses for which photovoltaics is cost effective on a life cycle cost basis in comparison to conventional energy supplies. As a question of a rational use of available funds, especially in developing countries, the use of photovoltaics should be concentrated on those applications for which economic advantages are plausible.

In this chapter a financial evaluation of the power plant under investigation is presented. This is important in order to understand how feasible the plant is in the local environmental conditions. This evaluation has been performed using the theory of Cost Benefit Analysis on a life cycle cost basis, also called Life Cycle Cost Analysis (LCCA). The economic assessment here undertaken has been concentrated on two aspects: (i) to determine the unit cost of services provided by photovoltaics and (ii) to assess the feasibility of the PEI unit referred in chapter 3 for reducing the costs of PV energy services.

The following aspects have been excluded in the analysis: (i) environmental issues, (ii) the impact of the technology to the national economy as a whole, (iii) the social issues linked

with the use of the technology and (iv) the value of clean water to health and life. This omission was intentional, since the quantification of parameters linked with the aspects mentioned still requires the development of a consistent methodological framework.

## **4.2 Background Theory of Cost Benefit Analysis**

Cost Benefit Analysis (CBA) is the quantitative basis for decision making in investment affairs. It is an evaluation methodology in which impacts are measured in monetary values. Here this theory is being reviewed, based on references [1-7], having in mind its applications in energy projects.

### **4.2.1 Data requirements**

Techno-economics begins with the compilation of all expenditures and incomes connected with a particular project. The most relevant data for undertaking this task can be divided in the following classes:

- . Investment parameters;
- . Equipment;
- . Expenditures;
- . Income;
- . Returns and
- . Depreciation.

#### **4.2.1.1 Interest Rate**

Interest rate represents the cost of borrowing money; it is a function of supply and demand for money and of government policy as well:

$$I = (1 + i)(1 + f) - 1, \quad (4.1)$$

where  $I$  is the market interest rate,  $i$  is the actual cost of money due to supply and demand and government policy, and  $f$  is the general inflation rate.

The relation between the value of money presently and in the future can be given by the following equation:

$$V_t = V_o(1 + I)^t, \quad (4.2)$$

where  $V_t$  represents the value of money at the end of year  $t$ ,  $V_o$  the present value of money,  $I$  the annual interest rate and  $t$  the time in years.

#### **4.2.1.2 Discount Rate**

In order to provide present value of money from its future value, equation (4.2) can be rearranged as

$$V_o = \frac{V_t}{(1 + DR)^t}, \quad (4.3)$$

where  $DR$  represents the discount rate, a parameter that in essence has the same significance as that of the interest rate.

#### **4.2.1.3 Inflation Rate**

Prices paid for goods and services may increase as a result of different reasons. This feature is called inflation. It is, normally, expressed as an annual percentage and determined by:



$$f(t) = \frac{PI(t)}{PI(t_0)} - 1, \quad (4.4)$$

where  $PI(t)$  is the price index at year  $t$  and  $PI(t_0)$  the price index at year  $t_0$ .

#### 4.2.1.4 Energy Escalation Rate

In the analysis of projects which are heavily dependent on energy, it is recommended to take separate account of the development in energy prices, which may not behave in sequence with the general inflation rate. The determination of the annual energy escalation rate should be based on the price index of the particular source being investigated. Using the expected real increase in the cost of energy and the general inflation rate, the energy escalation rate can be determined as

$$e(t) = [1 + e^*(t)][1 + f(t)] - 1, \quad (4.5)$$

where  $e(t)$  is the annual energy escalation rate,  $e^*(t)$  is the real annual rate of increase in the cost of energy and  $f(t)$  is the annual inflation rate.

#### 4.2.1.5 Service Life of an Installation

The service life of an installation is the number of years beyond which the system's maintenance costs per year become higher than the depreciation of replacement per year, or when the efficiency of the system deteriorates such that the output product is unacceptable in quality and/or in quantity.

#### **4.2.1.6 Investment Costs**

All costs in money and assets to be assumed in order to carry out the project concerned are known as investment costs. It includes the capital costs and the recurring or revenue costs, but not the income

#### **4.2.1.7 Residual Value of a Plant**

The residual value of a plant or of individual components is determined from the possibilities of its alternative use. On the assumption that equipment or parts of a plant can be sold, the expected liquidation yield from the sale is usually taken as the residual value.

#### **4.2.1.8 Major Operating Costs**

The major operating costs of a project include:

- . Manpower costs;
- . Maintenance Costs;
- . Energy costs;
- . Taxes;
- . Insurance;
- . Security.

In utilising solar, wind, hydroenergy as well as geothermal energy, it can be assumed that the energy source will be directly available in the required quantity and quality, free of charge, after the installation of the necessary plant at any suitable selected site. Nevertheless, when biomass or conventional energy sources are used, it must be noted that costs will arise for the procurement, transport, processing and storage of the relevant energy sources, for feeding the plant, for discharging of residues and also payments to dispose biomass and other wastes.

#### **4.2.1.9 Depreciation**

Depreciation can be defined as the decrease in value of an asset due to use and/or time. A very simple operational definition of depreciation can be given as:

$$AD = RV(t) - RV(t + 1), \quad (4.6)$$

where AD represents the annual depreciation,  $RV(t)$  is the present value of the residual value of the asset in time  $t$  and  $RV(t+1)$  is the present value of the residual value of the asset in time  $t$  plus one year.

#### **4.2.2 Procedure of Cost Benefit Analysis**

In this section the most common methods to undertake cost benefit analysis, or financial analysis, are summarised. Normally, six approaches are used in appraisal of energy projects:

- . Net Present Value (NPV) method;
- . Internal rate of return;
- . Annuity method;
- . Cost annuity comparison method;
- . Calculation of pay-back period and
- . Sensitivity analysis.

A project subjected to any financial evaluation method will have its costs and benefits spread over a number of years. In order to compare one project with another, one must reduce the time stream of costs to a single number. This is most easily done by the use of a present value function (PVF). This function can be used to determine the present value of

a yearly income or expenditure which escalates at some fixed percentage each year, from year 1 to year N. It is defined as

$$PVF(DR, B, N) = \frac{1+B}{DR-B} \left[ 1 - \left( \frac{1+B}{1+DR} \right)^N \right], \quad (4.7)$$

$$PVF(DR, DR, N) \rightarrow 1 \quad \text{for } DR \rightarrow B, \quad (4.8)$$

where DR is the discount rate, B is the escalation rate (general inflation rate or energy escalation rate, e) and N is the number of years.

Any yearly expenditure that is expected to escalate at some fixed rate B, owing to inflation, f, or energy price escalation, e, may be multiplied by PVF(DR, B, N) in order to determine its present value. For the special case where B=0,

$$PVF(DR, 0, N) = \frac{(1+DR)^N - 1}{DR(1+DR)^N} = \frac{1}{CRF(DR, 0, N)}. \quad (4.9)$$

The reciprocal of the PVF, with B=0, is commonly referred to as the capital recovery factor (CRF). When multiplied by an initial sum of money, the CRF determines the periodic payment necessary to pay back that sum of money at interest rate DR over N periods.

#### 4.2.2.1 Net present Value

The NPV of an investment project at the point in time t=0 is the sum of present values of all cash inflows and outflows linked to it. In simple terms the NPV can be indicated as:

NPV=Present values of (Annual Returns-Investment Costs+Liquidation Yield)

$$NPV = (INC - EXP)PVF(DR, f, N) - \sum_{t=0}^N I_c(t) \frac{(1+f)^t}{(1+DR)^t} + RV \frac{(1+f)^N}{(1+DR)^N}, \quad (4.10)$$

where INC is the annual income, EXP is the annual expenditure,  $I_c(t)$  is the investment cost,  $t$  is the time period of investment,  $N$  is the service life of investment, DR is the discount rate,  $f$  is the general inflation rate, RV is the residual value of the investment project and PVF is the present value function.

An investment project is only profitable when

$$NPV \geq 0.$$

In comparing several investment alternative projects, the NPV of the different projects should be compared as a guide with one another and investment with the highest NPV should be selected.

#### 4.2.2.2 Internal Rate of Return

The internal rate of return (IRR) represents the critical discount rate, that results in a zero NPV for an investment project. An investment project is profitable if

$$IRR \geq DR.$$

Comparing different investment projects, the project with the highest IRR is the most profitable.

#### 4.2.2.3 Annuity Method

The annuity method aims to convert all the net cash flows connected with an investment project into a series of annual payments of equal amounts. The conversion takes place by multiplying the NPV by  $CRF(DR, N)$ :

$$Annuity = NPV \cdot CRF(DR, N) . \quad (4.11)$$

An investment project is considered profitable when

$$Annuity \geq 0.$$

Comparing different investment projects, the project with the highest annuity should be adopted.

#### 4.2.2.4 Cost Annuity Comparison Method

This method is a shortened form of the annuity method without the inclusion of income in the calculation. Cost annuity, CAN, is given by:

$$CAN = \left[ EXP. PVF(DR, f, N) + \sum_{t=0}^N I_c(t) \frac{(1+f)^t}{(1+DR)^t} \right] \cdot CRF(DR, N) . \quad (4.12)$$

In comparing different investment projects, the alternative with the lowest cost annuity should be chosen.

#### **4.2.2.5 Pay-back Period**

Beginning with the year of the first payment, the present values of the annual net cash flows are summed until the total reaches a value of zero. The time from commissioning up to this point is called the pay-back period. An investment project is favourable if the capital invested plus a minimum acceptable rate of interest is recovered by means of anticipated returns within the service life or within a maximum acceptable pay-back period, which must be shorter than the technical service life. In evaluating the relative acceptability of alternative investments, it is assumed that the investment alternative with the shortest pay-back period is the most favourable.

#### **4.2.2.6 Sensitivity Analysis**

Since techno-economics deals with the future, of which one can never be certain, a single evaluation of economics with some expected values of variables seldom provides sufficient information on which to base a wise decision, due to the fact that these variables may contain uncertainties. Sensitivity analysis is a tool to evaluate the effects of uncertainties, quantifying the economic consequences of a potential but unpredictable development in important parameters. Generally, values of investment parameters, equipment, expenditures, etc., are varied by certain percentages from the expected value and the effects upon the output financial parameters are investigated.

### **4.3 Life Cycle Cost Analysis of the Plant**

The photovoltaic system under investigation at present is not for commercial purposes, but for development, thus the benefits derived from its energy services will not be quantified in monetary values. Furthermore, the residual value of the system will be set to zero, by considering the system life time sufficiently long. In this way, the expression (4.10) becomes:

$$NPV = EXP. PVF(DR, f, N) + \sum_{t=0}^N I_c(t) \frac{(1+f)^t}{(1+DR)^t}, \quad (4.13)$$

In this case the Cost benefit Analysis is called Cost effectiveness Analysis (CEA), since it considers only costs. Expression (4.13) is generally called the expression of cost effectiveness analysis.

### 4.3.1 Major Assumptions

In this appraisal the following assumptions have been considered:

. There is no experience about the real life of PV systems for terrestrial applications, since it is a very recent technology and still in development. Predictions on this matter vary from author to author, nevertheless values of 20 years (likely to be much longer) for the array and 5 years for the inverter and the motor pump unit are of consensus among many authors. Therefore a 20 years period for the analysis will be used; recurring costs will be considered for the inverter and the motor pump unit;

. The PV power plant is assumed to be fully financed for a debt term of 20 years (the life time of the array) by a development aid agency. Discount and interest rates of 10% are normal (for loans provided by development banks), and an inflation rate of 5% is also realistic [1];

### 4.3.2 Base Case Description

The CIF Maputo cost of the system under investigation is of 12000 US\$ (see appendix F for costs). Replacement costs are of 1800 US\$ every 5 years for the motor-pump unit and the inverter (each unit has costed approximately 900 US\$). According to El Safi



estimations [8], the cost of a PEI unit of the type described in chapter 3 may be of about 40 US\$.

The drilling of the borehole has cost in total 2200 US\$ and the installation of the storage tank 1300 US\$. These figures include material and labour, according to the invoice of local enterprises which performed the work. Fencing is estimated at 300 US\$.

The labour cost for installation of the pumping system itself has been estimated by the author at 800 US\$, as this work has been done by him together with Eduardo Mondlane University's technicians. This figure includes life insurance for technicians and transportation of the hardware from the port to the local of installation (10 km). Miscellaneous cost (e.g. maintenance) account for 1% of the capital cost every year. Import taxes paid for this system account for 60% of the system's cost of 12000 US\$.

Based on the monitoring activities undertaken in the period from January to June of 1995, the monthly mean values of DC and AC energy and of water flow were calculated for each month and then for the whole period. Table 4.1 gives an account of such information.

Table 4.1: Monthly mean values of DC/AC energy and of water flow.

Year	Month	DC Energy [kWh/Day]	AC Energy [kWh/Day]	Water flow [m <sup>3</sup> /Day]
1995	Jan	3.9	3.7	11.2
1995	Feb	3.9	3.6	11.4
1995	Mar	3.6	3.2	09.9
1995	Apr	3.4	3.2	09.5
1995	May	3.4	3.1	08.9
1995	Jun	3.5	3.2	10.0
Average		3.6	3.3	10.2
Maximum		3.9	3.7	11.4
Minimum		3.4	3.1	08.9

#### 4.3.3 Calculation Procedure and Results

Using the cost information given above and the average values of system's output during the period of analysis, which is of 3.6 kWh for DC energy, 3.3 kWh for AC energy and 10.2 m<sup>3</sup> for water flow, and using the expression of cost effectiveness analysis, having in mind the assumptions above outlined, the unit costs of energy services provided by the PV system under investigation were determined. Sensitivity analysis has been performed considering the variation of costs in 20% and assuming maximum and minimum values of the system's yield registered during the period of analysis. From such calculations resulted the average unit costs for energy and water flow and also the costs at the best and worst cases. The results of these calculations are shown in tables 4.2 and 4.3. In Figures 4.1 through 4.3 data of table 4.2 are presented graphically.

Table 4.2: Total unit costs of energy services provided by the PV system, when import taxes are excluded.

<b>Designation</b>	<b>Cost in Best Case [US\$]</b>	<b>Cost in Average Case [US\$]</b>	<b>Cost in Worst Case [US\$]</b>
DC Energy/kWh	0.35	0.48	0.61
AC Energy/kWh	0.40	0.56	0.72
Water/m <sup>3</sup>	0.22	0.31	0.43

Table 4.3: Total unit costs of energy services provided by the PV system, when import taxes are included.

<b>Designation</b>	<b>Cost in Best Case [US\$]</b>	<b>Cost in Average Case [US\$]</b>	<b>Cost in Worst Case [US\$]</b>
DC Energy/kWh	0.53	0.71	0.90
AC Energy/kWh	0.60	0.84	1.07
Water/m <sup>3</sup>	0.31	0.44	0.60

### Unit Cost of DC PV Electricity

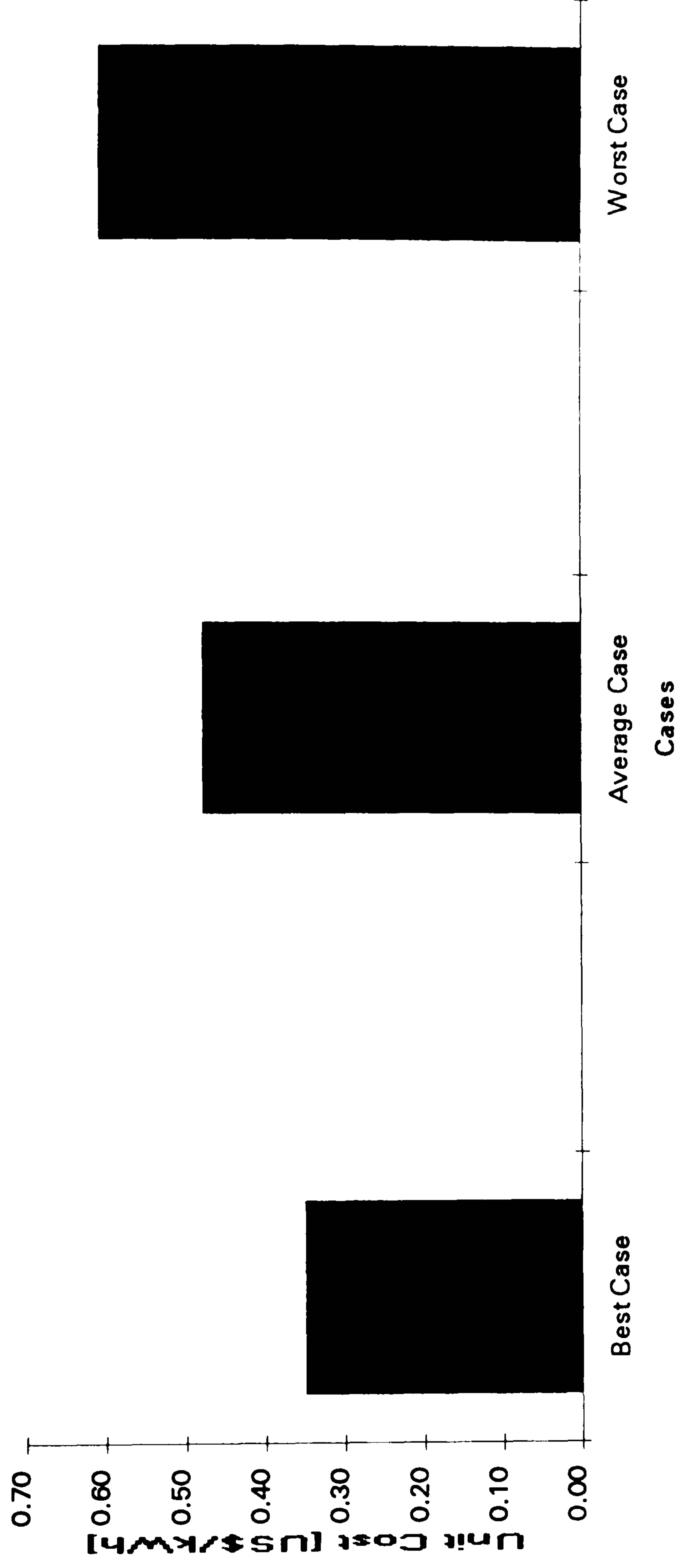

Figure 4.1: Unit cost of DC electricity produced by the PV array.

### Unit Cost of AC PV Electricity

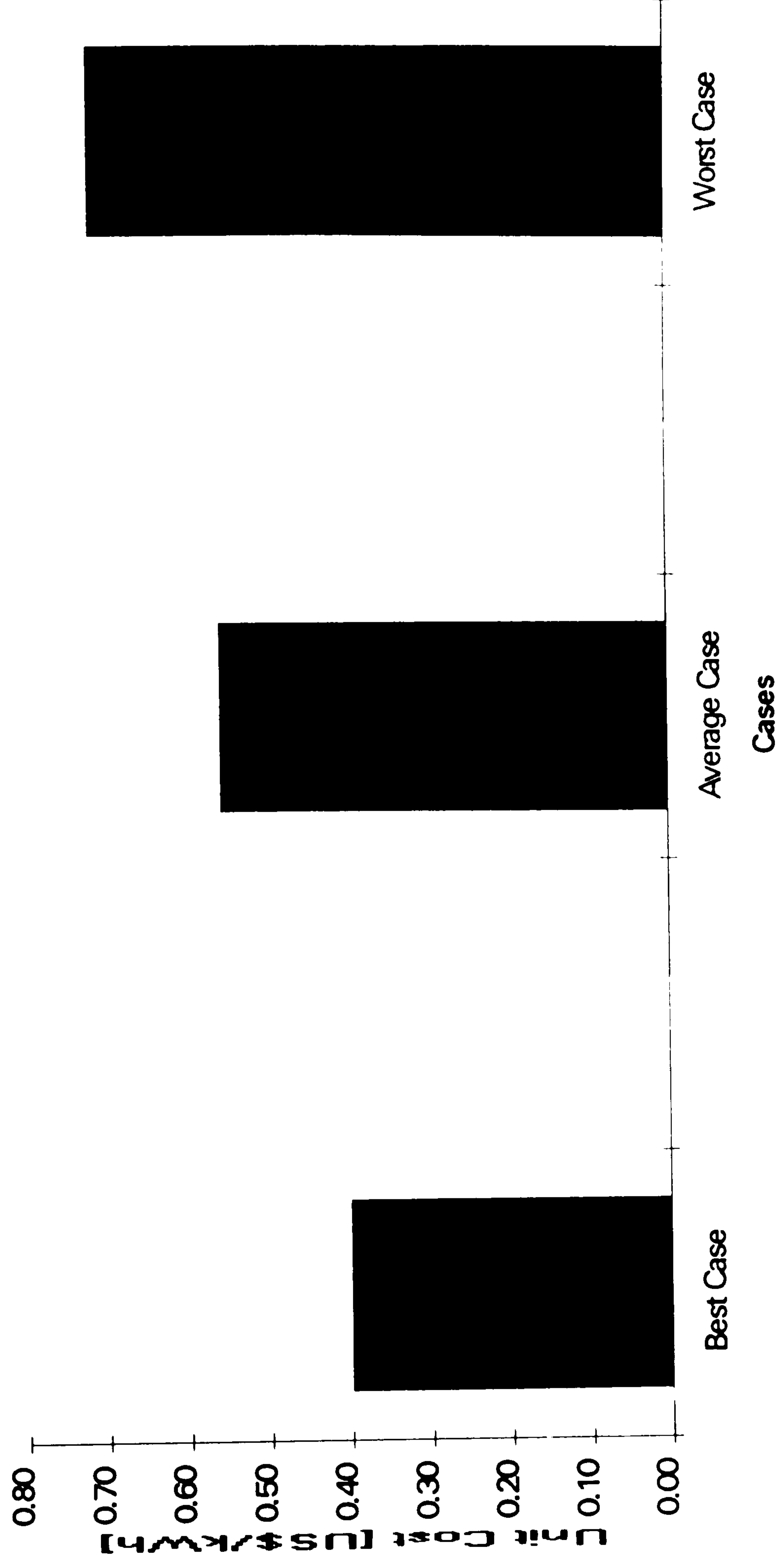

Figure 4.2: Unit cost of AC electricity produced by the PV array.

### Unit Cost of PV Pumped Water

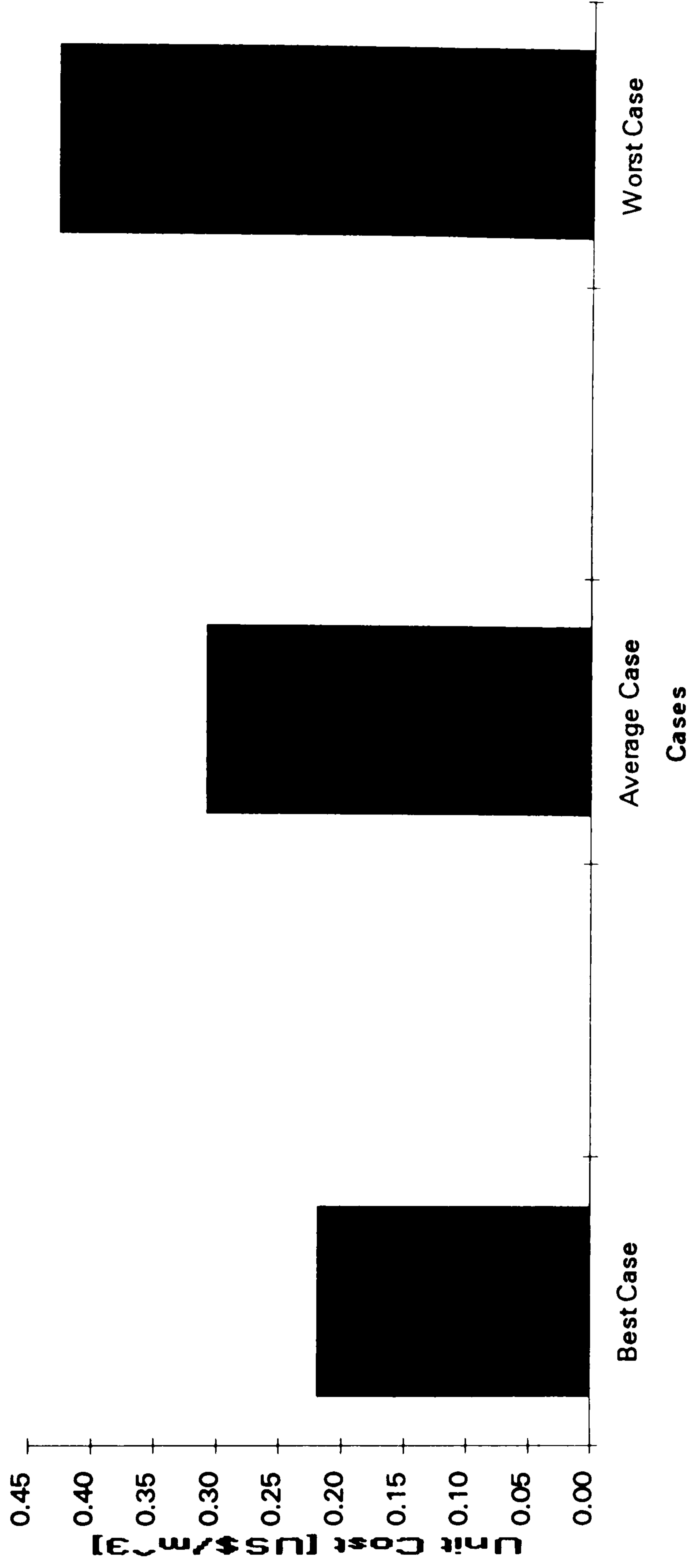

Figure 4.3: Unit cost of water pumped by the PV array.

#### **4.4 Conclusions**

In 1980 electricity from photovoltaic systems was costed at 100-400 cents per kWh [9]. By 1990 it was costed at 30-100 cents per kWh and was forecast to reduce to 4-6 cents per kWh by 2030. The value calculated here, 35-72 cents per kWh (when import taxes are excluded), is inside the admissible limits for the actual technology. The fact that the value calculated is closer to the lowest limit of the present cost of PV electricity mentioned above reflects that the local environmental conditions are appropriate for solar energy deployment.

The Power Utility in Mozambique sells electricity at the price of 12-16 cents per kWh. Thus PV electricity is 3 to 4 times as expensive as mains electricity in Mozambique. This means that PV electricity cannot yet be competitive to conventional electricity in the context of urban areas. Nevertheless, in rural and remote areas, where no mains grid is existent, photovoltaic electricity can be competitive to grid extension or to conventional alternatives like stand alone diesel generators. This is in agreement with studies undertaken by other authors [10-12]. According to [13], electricity from diesel generators often costs over 100 cents per kWh and grid extension may cost 8000-12000 US\$/km. When import taxes are included, the cost of PV electricity per kWh varies from 53 to 107 cents.

The retail prices of water provided by the National Water Utility in Mozambique are 26-38 cents per cubic metre. The cost of 22-43 cents per cubic metre of water provided by PV (when import taxes are excluded) reveals clearly that for water pumping applications photovoltaics is very competitive with conventional systems. If import taxes are included, then the cost per cubic metre varies from 31 to 60 cents.

Apart from the costs of energy services provided by photovoltaics, another issue of great importance considered in this chapter is that of the effectiveness of integrating a power electronic interface unit in the water pumping plant. As mentioned, that device was built-in in the inverter. The actual inverter cost of 900 US\$, including the PEI unit (whose cost has been estimated as 40 US\$), represents 7.5% of the whole system cost; thus the PEI unit device would account for 0.30% of the whole system cost of 12000 US\$. According to the results of chapter 3, with the use of the PEI unit, a gain in global efficiency of 0.40% has been achieved. Since the cost increase associated with the use of the PEI unit is of 0.30%, it is to conclude that there is a cost reduction of 0.10% in the energy services provided by photovoltaics, resulting from the use of the PEI unit. This means that the use of such a device can be especially cost effective in larger systems.

## References

- [1] F. Lasnier and T. G. Ang "Photovoltaics Engineering Handbook", Adam Hilger, 1990.
  
- [2] Harley H. Henricks and Graeme M. Taylor "Programme Budgeting and Benefit Cost Analysis", Pacific Palisades, Calif: Goodyear, 1969.
  
- [3] R. F. De La Mare "Manufacturing Systems Economics", Technological Management Consultants, 1982.
  
- [4] José A. Sepúlveda et al. "Engineering Economics", Schaum's Outline Series, 1984.
  
- [5] O. Hohmeyer "Social Costs of Energy Consumption", Springer Verlag, 1988.



- [6] H. Jones-Lee and E. Van Ierland "Valuation Methods and Policy Making in Environmental Economics", Elsevier Science Publishers, Oxford, 1989.
- [7] A. N. Mustafizul Karim and Md. Mizanur Rahman "Cost-effective Analysis on the Suitability of Photovoltaic Pumping Systems in Bangladesh", Solar Energy Materials and Solar Cells Volume 30, 1993, Pages 177-188.
- [8] Osman E. O. El Safi "The Use of Power Electronic Interface in the Efficacious Utilisation of Power in Photovoltaic Pumping Systems", Ph.D. Thesis, Newcastle Upon Tyne Polytechnic.
- [9] Robert Hill, Phil O'Keefe and Colin Snape "The Future of Energy Use", Earthscan Publications Ltd., London, 1995.
- [10] Phil O'Keefe "Photovoltaics for Development: Identifying Real Opportunity", in Applications of Photovoltaics, Edited by R. Hill and N. M. Pearsall, Adam Hilger, 1989, Pages 26-38.
- [11] R. Hill "Photovoltaics in Developing Countries", Proceedings of the 9th EC PVSEC, Freiburg, Germany, September, 1989.
- [12] R. Hill "Review of Photovoltaics", Paper prepared for Royal Institute of International Affairs, 1989.
- [13] ETC Foundation "Photovoltaics for Development", UK, 1991.

## **Chapter 5**

### **Non-Technical Issues for Promotion of Photovoltaics**

## 5.1 Introduction

The work being presented in this dissertation was the first research activity in photovoltaics carried out in Mozambique. Therefore, there was a need to undertake also non-technical studies concerning the applications of photovoltaics in the country, in order to enable the research team to give its support to the different emerging development projects willing to deploy the technology. There is a great consensus among specialists [1-4] that the major problems still hindering the widespread use of photovoltaics are common to those occurring with every new technology and can be grouped in the following five categories:

- . Financial,
- . Institutional,
- . Social,
- . Infrastructural and
- . Technical.

The financial barrier is still the biggest hurdle to take. The costs of photovoltaic systems are high because of import duties (60% in Mozambique so far), scarce availability of capital, high interest rates (45% in Mozambique) and short loan periods [3,4]. The required investment is fairly high for rural families, knowing that in many countries only 10% to 20% of the rural population earns more than US\$100 per month. The institutional problems are the next category. The major problem is the lack of specialised centres to support the implementation of projects. Social problems occur as well: people are not properly informed about the performance of the systems, including the advantages and disadvantages of such systems as compared to other alternatives; the training of owners is many times insufficient. The infrastructural problem is linked with the fact that after sales service is many times either non-existent or poorly organised, publicity is insufficient, wrongly targeted, or even negative [3,4]. Then, of course, there are technical problems associated with a new technology. In

almost all cases, problems are with the conventional part of the system, but not with the PV modules themselves.

How to solve all these problems is the major challenge for the whole PV community, including business people, politicians and the different organisations committed with the promotion of the technology. In this chapter the potential role of renewable sources of energy, in general, and of photovoltaics, in particular, in rural development promotion is qualitatively and quantitatively assessed by means of end use analysis and life cycle cost analysis. Afterwards, a model for an effective technology transfer of photovoltaics to developing countries, and in particular to Mozambique, is presented.

## **5.2. Energy Technology Options in Rural Areas: A Case Study in Mozambique**

### **5.2.1 The Country's Resources**

Mozambique's energy resources can be classified into the following categories: (i) commercial forms of energy, consisting of hydropower, natural gas and coal; (ii) biomass products, a group comprising fuelwood, vegetal coal and animal dung, and (iii) Environmental sources of energy, from which solar and wind may have a special relevance in Mozambique.

Hydropower is Mozambique's most important commercial energy resource, with the potential estimated at about 14000 MW, of which about 2250 MW has so far been developed, 2075 MW at Cahora Bassa and the remaining 150 MW is distributed among a number of sites throughout the country [5,6] (see appendix G for the map of Mozambique). All of the capacity at Cahora Bassa, except for Mozambique's entitlement of 200 MW, is committed to the supply of electricity to South Africa, Zimbabwe, Swaziland and Malawi. Apart from hydro resources, Mozambique has large sedimentary basins of oil and gas, both on-shore and off-shore. Geoscientific-analysis, based mostly on on-shore wells, indicate that organic content is dominated by gas-prone material while the geological and seismic surveys indicate presence of oil-

prone source rock eastward into the off-shore area. The basin has been explored for decades and although three accumulations of gas have been discovered on-shore at Pande, Temane and Buzi, the full extent of the country's hydrocarbon potential has yet to be established. There are plans to use the Pande-gas for local generation of electricity and for export to South Africa. Concerning coal resources, Mozambique has three relatively large known deposits at Moatize-Minjova, Senangoe and Mucanha-Vuzi. Total reserves are estimated at about 3 billion tonnes, of which about 850 million tonnes are proven reserves [5,6]. Coal has been produced since 1940, from the Moatize underground mines, both for in country use and export. The operations had to be suspended in 1981 due to political reasons. Studies are now being undertaken in order to determine the viability of continuing the activities.

The natural forest is the main supplier of fuelwood for the domestic needs of the rural population, which constitutes 85% of the total population. Studies undertaken reveal that 83% of the total energy consumption in the country comes from the forest, and that natural forests also supply fuelwood to some industries and to 60% of the urban populations [7]. The total consumption of fuelwood in 1990 was estimated to be 16 million cubic metres. In global terms, total demand for fuelwood is large. The annual sustainable yield of some 35 million cubic metres is, however, twice as large as the demand [8,9], but there are specific areas facing deforestation mainly because of the massive relocation and concentration of the population in some areas due to political and socio-economic problems and, to a lesser extent, due to disruptions in the supply of energy caused by destruction of the infrastructure for production, transmission and delivery of electricity and petroleum products. Forest reserves near the Maputo, Beira and Nampula/Nacala corridors have been depleted with attendant consequences for the environment.

Solar, wind and hydro power resources constitute the most promising renewable sources of energy in Mozambique. The country's geographic position, between the

latitudes 10° and 26° South, this means inside the "sunbelt" 40° North to 40° South (see appendix G for the map of Mozambique), is a privileged one as far as solar radiation is concerned. The average solar radiation in almost any part of the country is in excess of 4.5 kWh/m<sup>2</sup>/day and the number of hours of sunlight are close to 4000 per year. Concerning wind resources, although the speed of the wind over the Mozambique interior is frequently less than 2 m/s, the sea breeze at many locations along the coast line, which is of about 2800 km, may well attain 4.5 m/s [10]. This useful breeze does not penetrate far inland, often a matter of only about 5 Km, depending on the topography at the area. In high lands of the interior and in the proximities of water bodies, like rivers and lakes, and in islands the wind regime can be compared to that of the coast line. The mini/micro hydro potential is also high, since the number of rivers and water flows crossing the country is high. Nevertheless, its exact potential is still to be determined.

### **5.2.2. Energy Demands**

About 85% of the about 16 million inhabitants of Mozambique live in rural areas, distributed in an area of some 800,000 square kilometres, considering both the continental part of the country and the islands. In terms of major economic undertakings of rural populations in Mozambique, they can be grouped in the three main categories:

- . Populations living close to the coast line;
- . Populations living in the interior of the country and
- . Populations living in islands.

Major undertakings of coastal populations are agroforestry farming systems and also fishing for those who live very close to the sea or near rivers or lakes. Cashew nut trees is the dominant forestry, available everywhere from north to south of the country, with special incidence in the northern provinces, and it is the major export product of

Mozambique. Coconut trees constitute the second cultivated forestry in the country. Other species of plants are cultivated, including native ones, although to a lesser extent. The major production in the interior of the country are cereals, especially in the valleys of rivers. Most areas of the interior are characterised by having good natural forestry and therefore good pastures. Thus, livestock-raising is another important activity in such areas. The main species raised are goats, which exist practically in the whole country, and also cows, particularly in the South of the country. Fishing is also practised by populations living in the proximities of rivers and lakes. In islands fishing is the major activity.

The development challenge in rural areas at the present moment consists of enhancing the energy security of vulnerable people and fragile environments through maintaining and strengthening rural production systems. Thus, energy cannot be considered separately from other development issues, on the contrary, rural energy needs form an integral part of rural development issue. A correct methodological approach to assess energy demands in rural areas should be based on end use analysis [11], taking into account the specificities, potential and development perspectives of each region. The end use approach starts with the demand side, this means the person or organisation who is using energy, rather than laying the usual emphasis on the supply side. Using such a methodology the major sectors of energy consumption in rural areas of the country were identified as follows:

#### **. Water needs**

This region is, since the past decade, facing serious water shortages. As no rural development can be undertaken without a guarantee of critical quantities of water, a key issue in rural areas is to develop techniques for identification of water sources, to promote cost effective technologies for its exploitation and effective ways for its use.

### **. Household activities**

In households energy is mainly required for cooking, as the dominant end use, as well as lighting and space heating.

### **. Food production and processing**

Agriculture and cattle raising are the major rural undertakings related to food production requiring energy, in general for water supply. Other important uses of energy in this sector include crop and fish drying.

### **. Rural industries**

The most common industries in rural areas are of small scale. Bread production, brick making and fabrication of tools represent some examples.

### **. Community services**

Health centres, schools and administrative offices represent important social institutions in the rural context, in which in many cases new uses of energy have to be promoted

## **5.2.3 Energy Options**

After defining the major enduses in rural areas of the country, the next step is to discuss the different technological options available to fulfil the demands. As rural populations live grouped in small communities spread over the country, no one technology can be identified which can be cost effective to satisfy all the needs listed previously. The choice of a supply system to fulfil a predefined enduse has to be based on a comparative assessment of different technological options considering parameters of (i) cost effectiveness, (ii) reliability and (iii) sustainability, among others.

In the water supply sector there is a range of supply systems appropriate for the rural context: (i) hand, (ii) wind, (iii) solar, (iv) diesel and (v) water or hydro power pumps.



Which system to use in a specific application depends on the availability of resources, the profile of demand and the relative cost effectiveness. According to recent studies [3], undertaken in the context of a very vast region, in the sunbelt 40° N to 40° S, photovoltaics is fully cost-effective for hydraulic energies (hydraulic energy is here defined as the product of head times the daily volume delivered) above about 20 m<sup>4</sup>/day, below which hand-pumps may be used, and below about 1000-2000 m<sup>4</sup>/day, above which diesel pumps are usually to be favoured. Water supplies for villages of 20-2000 people and their livestock are thus most cost-effectively provided by PV pumps [3].

The household energy sector is dominated by cooking, for which biomass in the form of fuelwood will continue to dominate the supply side in a foreseeable future. Space heating in cold days will also continue relying on fuelwood. Another important enduse in households is lighting. So far, lighting is generally based on kerosene lamps. Such light is of poor quality, unreliable and not healthy. Photovoltaics and wind generators can contribute to changing the life style in a village by providing a better quality light based on electricity, which is more reliable and healthy. Furthermore, the same system can be used to power radio sets. This is very attractive if it is considered that a lighting kit is more cost effective than a kerosene lamp in a life cycle basis [3].

As far as food production is concerned, motive power is the first prerequisite. This will continue being satisfied by human muscle, animal traction and diesel fuels. Nevertheless, water supply will rely mainly on solar, wind and diesel systems. For food processing, especially drying of crops and fish, solar thermal systems could have advantages compared with the traditional methods, which are susceptible to contaminations.

Rural industries represent a class of energy demands for which in general a combination of different supply systems is required. In a bakery, for instance, fuelwood

is needed for bread production, while a hand pump would be useful for water supply and a wind or solar generator could provide the supply of electricity.

The category of community services is also an important one. Water supply needs are common in all institutions, especially schools and health centres, and technologies for this purpose have been already discussed. Lighting is more important for health centres, but also for schools in order to enable people working during the day to have opportunities to improve their knowledge in the night. Health centres require additionally energy for hot water, to maintain cold chains for vaccines, and also for telecommunications. Telecommunication systems are also required in administrative offices. In applications like lighting and telecommunications solar and wind energy are the most appropriate options. Solar and wind electricity generators enable for the first time the opportunity to carry out demonstration experiments in electricity in rural schools.

#### **5.2.4 The Potential Role of Photovoltaics for Rural Development in Mozambique**

In previous sections an analysis has been undertaken on rural energy demands and the different available technologies to supply such needs. Here the specific role of photovoltaics in enhancing rural development is being assessed. This work has required, first, the identification of niches of applications for which photovoltaics is technically viable and then the determination of ranges of its cost effectiveness as compared to other technological options. Field work has been undertaken for this purpose in some rural areas of the country in order to identify a village which could be used as sample for this assessment. Such a village should be as representative as possible for situations encountered in most rural areas of the country. Based on information collected during the field work activities, specific niches of application of photovoltaics in rural areas have been determined. Afterwards, using considerations of developmental nature supported by the economic methods outlined in chapter 4, photovoltaic systems have been compared with other options in specific case

applications. Major findings of these investigations are outlined in the following subsections.

#### **5.2.4.1 Description of the Sample**

The sample identified for this assessment was a village, whose name is Massaca, located in the district of Boane, province of Maputo (see appendix G for the map of Mozambique). It had a population of about 2000 inhabitants, from which more than about 90% were peasants, owning from half to one hectare of land and some units of livestock. Some few farmers, owning more than five hectares of land and some tens of units of livestock, were also available.

The activities of most peasants families are oriented for subsistence. Men, in general, are responsible for producing some cash money, so that the family can acquire goods and services which cannot be produced at the household level. Therefore most men work in towns or in the South African mines, if they do not run their own businesses. Women are responsible for household activities, from which production in fields is an integral part. Men and male young participate largely in these activities in the time of clearing the fields and in ploughing them using animal traction. Other important household activities are cooking, gathering of fuelwood and supply of water. Female children and young join their mothers in these household activities. Male children generally look after livestock and help in ploughing activities.

The village was being served by an appropriate shop. Major enterprises founded included a mechanical workshop, a carpentry, a soap manufacturing establishment, a sewing unit and a bakery. As far as social infrastructure is concerned, the village had a school, a health centre, an administration office and a religious mission. Indeed the religious mission was very committed with the development of the village, supporting major developmental initiatives of the dwellers. Some of the local enterprises mentioned above emerged with the support given by the mission.

The most important sources of energy used in the village were, firstly biomass, especially for home cooking, for the bakery and for the soap manufacturing fabric. Kerosene lamps had a special place for lighting. Most families owned small radio sets powered by dry cell-batteries. Works in the workshop, carpentry and in the sewing unit were mechanically driven. The mission used a large diesel generator for pumping water from a bore hole, for lighting and for a few other needs requiring electric energy. Two to three families owned small diesel generators for lighting, powering of television/video sets and used cooking gas, especially to prepare their breakfasts early mornings, whilst fuelwood was used for cooking the main meals. Village water supply was provided through five boreholes using hand pumps, installed by aid agencies.

#### **5.2.4.2 Identification of the Major Niches of Applications of Photovoltaics**

On the basis of the field work undertaken in the village, the major niches of applications of photovoltaics in rural areas were identified as follows:

##### **. Water Pumping**

The provision of clean drinking water, readily available, is one of the key issues to be taken into consideration in any community. Impure drinking water is responsible for a large fraction of the illnesses and infant mortality in the country. Groundwater can be a good source for supplying reliably clean water, even in cases of droughts, but suitable technologies are required for lifting such water. Hereby photovoltaics can play its role.

In that village queuing times for collecting water could take sometimes even one full morning, as handpumps have an upper limit of hydraulic energies (hydraulic energy is here defined as the product of head times the daily volume delivered) of 20 m<sup>4</sup>/day. The total quantity of water needed in the village per day can be estimated at 80,000 litres, considering 40 litres per day and per person. Thus, the installation of PV pumping systems in each of the five boreholes, supplying each about 16,000 litres per

day, with appropriate storage tanks, could contribute to alleviate the population from queuing times, making them free for other productive activities. Assuming heads of about 40 metres, an about 1200 watts PV system in each borehole would produce the required 16,000 litres required per day. This corresponds to 21 to 24 modules system.

### **. Health Care**

The provision of health care in rural areas is a major task, which many times is seriously hindered by the absence of energy supplies. A major concern in rural health centres is the maintenance of cold chains for conservation of vaccines, which must be kept at temperatures between 0°C and 8°C from manufacture to injection if they are to be effective. Small refrigerators, with capacities of about 100 litres, are needed for this purpose and photovoltaics can be very effective in this application. Another important application of photovoltaics in rural health centres is for lighting purposes, as health centres very frequently have to undertake tasks during the night. Another aspect of rural health care, which is often overlooked, is the need to attract and retain skilled staff, who could easily find work in towns or cities. Their quality of life can be greatly enhanced by the provision of PV systems for lighting, music, TV/Video, helping to bring an improved standard of care to the rural areas. It is regrettable to say that the health centre of the village considered had no system for electricity generation.

In average 20 persons per day were visiting the health centre. Considering that such institutions need a considerable quantity of water, due to the whole hygiene that has to be maintained, a daily quantity of 5,000 litres would be good, for the health centre and the staff house. considering a head of about 40 metres, a PV pumping system with a capacity of about 400 watts would be required (about 7 to 8 modules system). For lighting and communication services the health centre would need about 80 to 100 watts (about 2 modules system). The staff house would need the same level of power for lighting, music and television. Another 80 to 100 watts would be required to power a small refrigeration system. This means that power levels of 700 watts or less would

be required to put the village health centre fully operational and with staff having enough motivation to work. Using photovoltaics for this application, it is important to make sure that each unit is independent from others, in order to avoid complications in the system.

### **. Educational Programmes**

Education is the key to social and economic development. The provision of TV/Video sets in schools can make a significant impact in teaching, both in exposing the children to high quality teaching through the visual impact of the medium and in giving them a view of the country and its place in the world. Adequate teaching of many aspects of a school's syllabus is possible only if a supply of energy is available. Laws of electricity and magnetism can be taught and demonstrated with the help of photovoltaics. In general the provision of even small amounts of power can make a dramatic difference to the understanding of the natural world for children in rural areas. Adult education is another area where PV can make a significant contribution. There is a continuing need for education in child care, farming methods, disease prevention etc. A video presentation can have much more impact than a traditional lecture without audio/visual aids, and the message can be put across with much more force.

A 40 to 60 watts system can power a television/video set and can be used for demonstration of natural laws in a school. In terms of photovoltaics, this would be one module system.

### **. Communications**

Small scale telecommunications can play an important role in rural development. They require little power, but reliability is often of paramount importance. Major power needs in rural communications are for radio transceivers in health centres and administration offices. Photovoltaics can be used with success in this application.

Apart from the health centre, whose needs in communications have been already considered above, the administration office would need about 40 to 60 watts for communications. This corresponds to a one module system, as photovoltaics is concerned.

### **. Home Power**

Kerosene lamps are the most common lighting units for more than 90% of rural households. Fuelwood is also used, especially for social purposes during cold seasons and days. Candles contribute for lighting in very specific cases. Kerosene lamps give a poor light, are a fire hazard and can take a significant fraction of the cash income of families. Power in rural households is also required for radio sets. Normally dry-cell batteries are used for this purpose. A unique photovoltaic system can power both a lighting unit and a radio set.

Home power is an urgent issue to be addressed. The number of families in the surveyed village was of about 400. Most of such families (about 90%) would see their standards of life improved with the introduction of about 20 to 40 watts of electricity, which can power at least two lamps and a radio set. This corresponds to one to two modules of 20 watts each, which are very suitable for home power purposes. The whole village would then need 8 to 16 kW of electricity. This can be a very cost effective programme of rural electrification, instead of grid extension, as most families have not got enough appliances which can justify the introduction of higher quantities of electricity.

### **. Multi-Use Applications**

Some institutions in the village may need energy not just for one specific need, but for different enduses. The health centre, for instance, may need energy for water pumping, vaccines refrigeration, communications and lighting. Rural industries and major business activities require generally multi-use services. Higher classes of the society in

rural areas, perhaps accounting for less than 3%, would require full electricity services or at least energy for lighting, for powering radios, music, television and video sets. Families with some cash, especially those incorporating workers in South African mines, use car batteries extensively for powering music sets on occasions of parties. The batteries are regularly taken to the nearest urban centres for recharging. Such families are common in the south of Mozambique. All these examples represent cases of multi-use applications, where photovoltaics still can play its role.

The case of health care discussed above is an illustrative example of multi-power applications needs. Energy requirements in this application may in general vary from hundreds of watts up to few kilowatts.

#### **5.2.4.3 Economic Assessment**

For the niches of applications here identified for photovoltaics, there is a number of alternative technologies which can be considered. In this subsection, an economic evaluation of the different options is presented.

##### **. Education, Communications and Rural Health Care Applications**

In the educational area, all that is required most of the times is a system that produces some tens of watts. Diesel systems have a critical size of about 4 kW, which is much higher than the demand. At low level power demands, no other system can beat photovoltaics.

Power options in communication systems include, apart from photovoltaics, diesel generators. Recent studies [12] reveal that for communication loads less than 7.2 kWh per day, this means 300 W continuous, PV powered systems are more cost effective than diesel-powered systems, for irradiance levels of about 5 kWh/m<sup>2</sup>/day. For communication loads above 7.2 kWh hybrid or diesel systems are generally to be favoured. Most communication loads in rural areas, generally health centres and



administration offices, are in the range of tens of watts, thus they are in the range of photovoltaics cost effectiveness.

In rural health care, the alternative option to photovoltaics for conservation of vaccines is that of kerosene powered refrigeration systems. According to studies undertaken in several countries [3], using PV systems, vaccines are maintained within the temperature limits, between 0°C and 8°C, for over 80% of the time, as opposed to about 60% for kerosene powered units. Costs per potent vaccine dose are about 40% lower for PV refrigerators than for kerosene refrigerators, and the reliability of PV units is much higher. Room for innovation in photovoltaics is still very wide. Thus the technology will be more and more cost effective than that based on kerosene. Since in Mozambique there is no much tradition in using kerosene powered refrigeration systems for vaccines conservation, it would be advantageous for the country to enter directly into the modern market of photovoltaics. In fact, the Ministry of Health has a large programme to install photovoltaics in most rural health centres and corresponding staff houses. A certain number of PV systems have been installed already by aid agencies.

#### **. Water Pumping, Home Power and Multi-Use Applications**

There are three cases of rural energy needs which deserve special consideration, namely water pumping, home power and multi-use applications, due to the fact that they are very specific in each socio-economic context. Here an economic evaluation is undertaken, based on the methodology developed in chapter 4, of using photovoltaics for such enduses as compared to the traditional methods.

As far as community water supply is concerned, three alternative options compete with photovoltaics, namely hand, wind and diesel pumps. Hand pumps have a physical limitation of being effective for villages of about 50 people. Above this limit, there are serious problems with queuing times. The village used as sample for this analysis was

seriously facing such problems. Wind pumps are very site specific, and thus not interesting for comparisons in such very general cases. Therefore photovoltaics and diesel systems have been considered in this analysis. The base case for this analysis is a daily energy requirement of 10000 litres, suitable for a community of 250 people consuming each person 40 litres per day, in accordance with the recommendations of the World Health Organisation. The water is pumped from a bore hole at a head of about 40 metres. A photovoltaic system considered to supply this demand is the one monitored in this work, described in chapter 3, and whose financial parameters were described in chapter 4. A diesel pump to supply the same demand has to be one rated at 4 kW, the minimum size available, whose cost may vary between 4000 and 6000 US\$. The life time of the system has been assumed as being of five years, with costs on operation, maintenance and fuel accounting for 20% of the capital cost every year. The discount and inflation rates were taken as 10% and 5%, respectively. Using these data and the expression of cost effectiveness analysis, presented in chapter 4, for a total period of analysis of 20 years, the cost of water per cubic metre has been determined as varying from 29 to 44 cents for diesel system, against 16 to 31 cents in the case of photovoltaics. Thus, at such levels of community water supply, photovoltaics is more cost effective than diesel systems.

Concerning home power, common systems are kerosene lamps, for lighting, and dry-cell batteries to power radios. According to the World Bank [13], total monthly charges for kerosene and dry-cell batteries may amount 10-15 US\$. So high prices are paid for poor services, in the case of lighting. Still according to the World Bank, solar systems are available on the market, which provide several times more light than does a kerosene lamp, with cost varying from 100 to 250 US\$. Costs of energy using the PV system here referred have been determined, using the theory of chapter 4. In this analysis, replacement costs for the BOS components of the PV system have been assumed as 15% of the capital cost every five years, during a total period of 20 years, whilst miscellaneous costs were assessed as 1% yearly. A discount rate of 10% and

inflation rate of 5% were considered. Under these assumptions, the cost of energy per month varies from 59 to 150 cents using the PV System. This is about 10 times lower, compared to what is now paid, and the services would be much better. Nevertheless, the capital cost of 100 to 250 US\$ is still high for the vast majority of rural dwellers. In order to alleviate this, the World Bank has been trying since 1995 to interest manufacturers in developing and producing low-cost solar lamps and chargers. The lamp, would be a small one, with 100-200 lumen, a life time of some three years and costing 25-50 US\$. The charger, also a small one, with 2-5 Watt and a lifetime of about three years, would be combined with nickel cadmium batteries, and thus allow households to replace their non-rechargeable dry-cell batteries, which are often of poor quality, and power a radio and a flashlight. Its cost would be also of 25-50 US\$. Such systems, which were supposed to have been tested during the past year, are not yet available on the market. They would provide double or quadruple the current lighting provided by kerosene lamps. The cost effectiveness of such systems has been compared with that of kerosene and dry-cell batteries. Major financial assumptions are as follows: miscellaneous costs are assumed as 1% yearly and discount and inflation rates as 10% and 5%, respectively. The total period of analysis is of 3 years, the lifetime of the systems. Under such assumptions, the energy costs per month vary from 71 to 140 cents, using such novel PV units. This means that in terms of cost effectiveness there is no difference between such units and the larger PV system considered above. Nevertheless such units bring a new input, in that their capital costs are so low that they can be purchased by most of the rural dwellers who buy kerosene lamps and dry-cell batteries today. This can represent a breakthrough for dissemination of photovoltaics, as high capital costs are the major constraints.

In multi-use applications diesel is the other option to be considered, in parallel with photovoltaics. The smallest diesel system is rated at about 4 kW and costs between 4000 and 6000 US\$. Assuming the same financial parameters as for the case mentioned above, and considering average energy demands of about 4 kWh, the cost

of energy has been determined as varying from 70 to 110 cents per kWh. This is in accordance with studies undertaken by other authors [12]. If it is considered, according to chapter 4, that PV electricity varies from 33 to 66 cents, then it is clear that at such demands, photovoltaics is the most cost effective option.

#### **5.2.4.4 Training Needs**

In view of the cost effectiveness of photovoltaics for most low power applications, a need may arise to disseminate this technology in rural areas. This will require the training of people so that such systems can be properly used. It is important to elaborate training strategies appropriate for each context. Taking the case of the village surveyed, health centres and administrations are under responsibility of ministries. Thus it can be effective that such ministries create a capacity in PV installation and maintenance in the existing maintenance services at local level. The staff in the specific unit can be trained by these services on proper use of the equipment.

As far as the use of PV by the community is concerned (e. g. enduses of water pumping and home lighting), this issue should be co-ordinated by a rural development agency. In Mozambique, a relevant body is the Institute for Rural Development. In almost all communities, one can find people with skills in different fields of technology, for instance electricity, mechanics, welding, carpentry, etc. This is due to the fact that there are people who have been working in towns for some years and then came back to their homes. In case of photovoltaics, it is important to identify people with electric experience and well accepted in the community and provide them with training on PV. These people can then help the community in installation and maintenance of PV systems on a commercial basis appropriate in the local context. This is the way services for repairing bikes, radios and other products have been spontaneously organised and the experience shows that they fit well into the village culture. Sometimes payment is required not in cash but in goods. These people can

effectively maintain the community PV pumping systems, as they live there and need water as well.

### 5.3 PV Market Analysis

The end use analysis undertaken above shows that photovoltaics has an important role for the development of rural areas. In order to explore the full capabilities of this technology it is important to have a general understanding of its market development up to date. As prices of PV systems are falling, the interest in deploying this technology is increasing. At the present time [14] the standard international price for a silicon wafer PV module in reasonable size orders (many kW<sub>p</sub>) is about US\$5/W<sub>p</sub>. The history of PV module costs and a projection to the year 2000 is shown in Figure 5.1. The projection covers a range of values, with prices in the range of US\$ 2-3/W<sub>p</sub> at the turn of the century, depending on the size of the market by that time. This is likely to be in the range 180-950 MW<sub>p</sub> p. a.. Most large PV companies are planning on the basis of around 300 MW<sub>p</sub> p. a. for which manufacturing plant in the range of 20-30 MW<sub>p</sub> p. a. will be appropriate. It is probable that module efficiencies will be then approaching 20%. The present price of US\$ 750m<sup>-2</sup> for a 15% efficient module will then need to fall to US\$ 600m<sup>-2</sup> to achieve US\$ 3/W<sub>p</sub> or to US\$ 400m<sup>-2</sup> to achieve US\$ 2/W<sub>p</sub>. The decrease in production cost by a factor of two should be achieved if the cumulative production output rises by a factor of ten. This factor of ten would be achieved by the year 2005 if production rose at 40% p. a. to 900 MW<sub>p</sub> p. a.. Cumulative production would rise by a factor of five if the output rises at 25% p. a. to around 300 MW<sub>p</sub> p. a., or a factor of four if output rises to 200 MW<sub>p</sub> p. a. by the year 2005. The price of US\$ 3/W<sub>p</sub> by the year 2005 is thus consistent with the lowest market projection whilst US\$2/W<sub>p</sub> is consistent with the upper projection. The medium projection of 300 MW<sub>p</sub> p. a. would suggest a module price of around US\$ 2.6/W<sub>p</sub> for module efficiencies of 20%.

The terrestrial market of photovoltaics is very diverse. In order to analyse it, it is essential to divide it into market segments which are relatively homogenous in their characteristics. None of the many ways of subdividing the PV market is fully satisfactory, but a useful set of categories can be presented as composed of six categories, namely [14-16] (i) the consumer indoor segment, (ii) the consumer outdoor, (iii) the remote industrial, (iv) the remote villages, (v) the grid connected and (vi) the central power plants segment. The first three segments represent real markets with true solvent customers; in 1990, they accounted for 50% of the shipments and 60% of the turnover. The last three segments represent markets subsidised for different reasons; now in 1995 they may count for 60% of the shipments and 50% of the turnover.

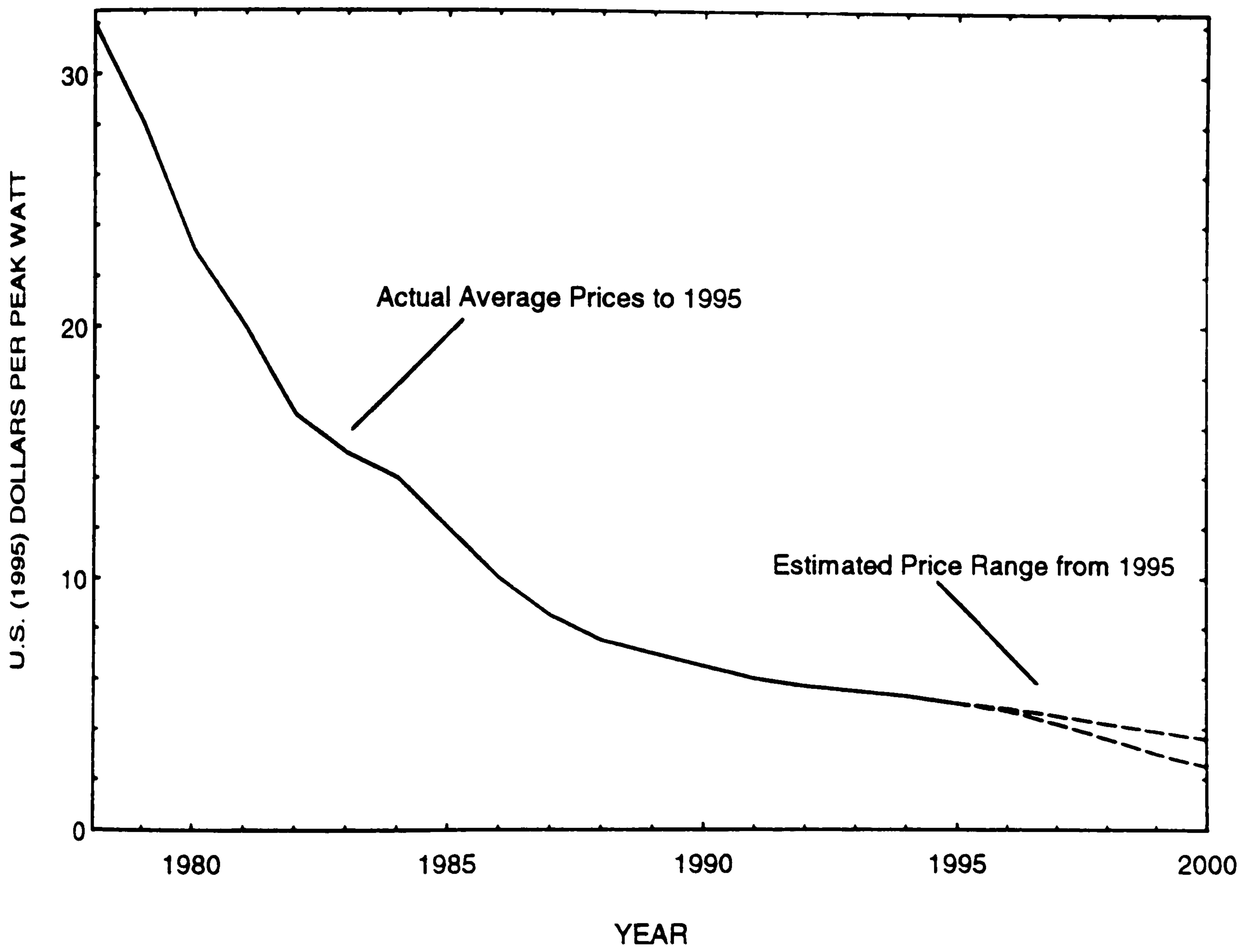

Figure 5.1: History of module costs, from source [14].

### **5.3.1 Consumer Indoor Segment**

This segment is comprised by devices with PV modules rating less than 1  $W_p$ , mostly based on amorphous silicon (a-Si:H) technology, has recently slackened the pace of the rapid growth of the past decade. It is assumed that the volume during the 90's will be constant, with the probable development of watches and novelties to compensate the saturated market of pocket calculators. Indoor consumer products are characterised by the fact that they are bought by individual consumers.

### **5.3.2 Consumer Outdoor Segment**

This category comprises systems using modules with less than 50  $W_p$ . About a half of such systems are based on a-Si:H technology. The other half, still based on crystalline silicon will see the rapid substitution by thin film products for obvious reasons of size and voltage flexibility as well as possibilities for better integration. This segment has a yearly growth of 15%. These products, like the indoor products, are also characterised by the fact that they are bought by individual consumers

### **5.3.3 Remote Industrial Markets**

The industrial markets, or professional systems, as they are often called, are characterised by the sale of PV modules or systems to industry which then uses PV for its own purposes. This could be for purposes within the company or the company could sell-on the PV system as a package with its own products. The broad categories comprising the industrial market are: telecommunications, navigational aids, cathodic protection, road signaling and environment. PV is cost-competitive in these markets because of the high costs associated with refuelling and maintaining internal combustion engines or in changing batteries or liquid gas cylinders. This market has been steadily growing at 15% per year and remains the most stable market today. For an historic lack of credibility, there is still some reluctance to let thin films intrude into that professional market.



#### **5.3.4 Electricity Services to Remote Communities**

Photovoltaics provides electricity for remote communities in both the industrialised and the developing countries. The range of services supplied is very wide and includes water pumping, water treatment, village supplies for domestic and small industry use, medical uses, educational uses, refrigeration, lighting, communications via telephone, TV and radio. Typically the capacity of the PV modules used varies from 100 W<sub>p</sub> to 10 kW<sub>p</sub>. This market is almost fully based on crystalline silicon technology, with a very sustained growth of 25% per year, accounting for 40% of the total market in 1990, with forecasts of 48% in 1995 and 54% in the year 2000. Some of these applications overlap with those of outdoor consumer products, but in this case the equipment is purchased by a utility, government agency or international agency for deployment in the community. The marketing, and in the third world, the supply and maintenance implications are quite different. In Australia, for instance, the utility is supplying Remote Area Power Supply (RAPS) systems to communities in the outback as a lower cost alternative to extending grid lines. The consumers are charged by the utility on the same basis as urban consumers as a matter of social equity. In the industrialised countries the utility or other authority uses PV or PV/diesel hybrids such as the RAPS systems as a good engineering solution to their problems when life-cycle cost comparisons show it to be the cheapest option. In developing countries the potential market is huge but the problems of introducing PV on a scale appropriate to the needs are daunting. This segment is tightly related to the national and international aid programmes. The impediments to its widespread use are no longer associated with the technology but with the socio-economic aspects of its implementation.

#### **5.3.5 Grid Connected Systems**

The large central station PV system feeding power into the utility grid was the vision of the original PV programme in the USA. Nevertheless the trend now is to focus on stand alone systems. There are two grid-connected markets which are much closer to being real market opportunities, the embedded and the distributed generation [14].

When a distribution network has a long line from the generating source, loads along that line can result in poor power quality at the far end of the line. This is reflected in voltage losses from line resistance, high harmonic content and poor wave factors from non-resistive loads along the line. If these result in power quality below an acceptable standard then the line and its associated switch-gear and transformers would be normally up-graded. Also, as the loads along the line grow, there comes a time when some critical point on the distribution line/feeder network becomes overloaded, requiring up-grading of lines, transformers and switch-gear. It has been shown that it could be cost-effective to install a PV plant feeding power to a sub-station at the critical point rather than undertake the expense of up-grading. These studies conclude that embedded PV generation could be cost-effective in carefully selected applications. Distributed generation is used here to denote the supply to individual buildings from PV attached to each building. The buildings are also connected to the grid, and take electricity from the grid supply when demand exceeds PV output or feed power into the grid when PV output exceeds demand. The great advantage of distributed generation from buildings is the very large area which could be covered without employing any additional land area. According to numerous marketing surveys, it is supposed that this market grows at a pace of more than 30% per year in countries where the legislation encourages, or at least allows private production directly connected to the local or national grid.

### **5.3.6 Central Power Plants**

The early large demonstration systems in California and more recently in Europe have shown the increasing recognition by utilities that PV may have a role to play within a 30 years planning horizon. Since PV is still far away from economic competitiveness with conventional sources of centralised energy, it is still a much debated question to decide whether photovoltaics will fulfil a significant part of electricity consumption by the mid 21st century, from central power stations or from decentralised production connected to the grid.

## **5.4 A Model for Building Endogenous Capability in Photovoltaics**

From the sections above, it is clear that photovoltaics has the potential to be a major source for development in developing countries. The impediments to the widespread use of PV in those regions which presently have no access to electricity are mainly unrelated to PV technology, but are financial, organisational and social in nature. PV programmes in developing countries fall into three broad categories. There are continuing demonstration programmes in countries which still need to build confidence in PV amongst decision makers and the population and an indigenous capability to make good use of PV. There are rural electrification programmes run by a government or a parastatal and there are now countries where PV is established as commercial business. In all of these cases, it is instructive to view the dissemination of PV as a form of technology transfer, thus for an effective transfer of PV to developing countries a deeper understanding of the overall issue of technology transfer can be important.

### **5.4.1 The Concept of Technology Transfer**

The transfer of technology is a transaction between at least two parties, the transmitter and the receiver [17-18]. The transfer can be directly from a PV company to a village in a developing country or through intermediaries. The roles and responsibilities of the transmitter and receiver of the technology need to be carefully thought through if the project is to be successful. For the transfer to be successful, both parties must be able to meet the essential needs of the other. The transmitter must be able to deliver a technology which meets the needs and the expectations of the receiver. This can be achieved by the transmitter describing accurately and honestly the characteristics of the available technology and then seeking amongst potential receivers for those whose needs and expectations are met by this technology. Alternatively, potential transmitters can survey the needs and expectations of potential receivers and develop technologies specifically designed for them. The receivers must be capable of accepting the

technology and making use of it. This is not merely a passive role but does, in fact, require an active participation in the transaction. These actions are easily done in a consumer society because the industrial, commercial and financial infrastructure already exist to facilitate such transactions. In other societies, this infrastructure may be incomplete and the receipt of technology may be difficult or impossible unless these problems are identified and addressed. It is as important to ensure that the receiver is able to accept the transferred technology as it is to ensure that the transmitter is able to deliver it. For the technologies to be appropriated successfully, hard technologies - machinery, equipment and factories - will usually be accompanied by complementary soft technologies - expertise, organisation and management methods, maintenance and R&D capacities - so that the techniques may be adapted and improved [17-18].

#### **5.4.2 Technology Transfer in Developing Countries**

The third world is often viewed as a rather similar block of poor countries, but in fact there is a very wide divergence in technical capabilities amongst developing countries. As Trindade has pointed out [19], one can identify three broad groups of countries. The first group are countries with a full range of institutions, technical skills, expertise for social analysis and a policy commitment for the full exploitation of renewable energy (e. g. India, Brazil, China and Pakistan). Next, there are countries with a relatively recent policy commitment and only a limited capability, or, conversely, no policy commitment but some capability (e. g. Kenya, Zaire and Zimbabwe). Finally, there are the countries with little or no policy commitment and low technical capability where both the technical skills and the mechanisms for the diffusion of the technology are inadequate, with little co-ordination between the few institutions or individuals active in the field. This wide divergence in the capabilities of developing countries means that policies for technology transfer must be tailored to the needs of each group. For the third group, to which belong the majority of Southern African countries, like Mozambique, the critical issue to be addressed in order to enable any technology transfer is that of creating endogenous capabilities in photovoltaics. Effective ways to

create such a capability have to be found in order to enable a successful technology transfer.

#### **5.4.3. Building of Centres of Expertise as an Effective Model for Creating Endogenous Capabilities in Photovoltaics**

There are two cases of extraordinary success in the history of technology transfer [20]: the first is the Japanese industrialisation process, with its start by 1868, and the second one is that of South Korea, starting by 1962. During their process of industrialisation, these two countries imported many new technologies in a wide variety of fields and at the same time made great efforts to improve these technologies and to adapt them to local conditions. The success of these efforts depended on many factors, the most important of which were the education of the general population and government initiative and support [20]. With that background it was possible for Japan and South Korea to make proper use of the imported technologies and gradually to manufacture locally some components by imitation of known technological processes. Both countries are now recognised manufacturers of light and heavy industry equipment, and Japan, for instance, had very quickly developed from the stage of imitative technology to that of creative technology, sharing presently the place of the five most powerful industrial countries in the world. The Japanese and South Korean experiences point out very clearly that the development of an endogenous capability is an essential factor for successful technology transfer.

PV pilot programmes have been promoted in a considerable number of developing countries. It is now important to assess the experience gathered in this process so far. The analysis will focus on the less developed third world countries, this means the third group, according to Trindade's classification. In most of them, the pilot PV systems existent were installed mainly by international aid agencies, using foreign experts and training local people at intermediate or low technical levels [2]. It has been found that in many cases where aid agencies have stopped the provision of assistance, the

programmes have foundered [2]. The hybrid photovoltaic/wind power plant, installed in the period 1986-1988 in Matola/Mozambique by an Italian aid agency, as a demonstration and training centre, is an illustrative example; it worked only for the two years of the duration of the project [21]. Examples of successful PV dissemination programmes in this group of countries are few; Mali and Zaire, which managed to disseminate pumping and refrigeration systems, respectively, on a national scale, are almost the exclusive exceptions [4].

There are many reasons for the failure of dissemination programmes in developing countries, but the major one lies in the weakness of the models followed for building the required endogenous capability. The training of local people at low and intermediate levels, as has been the practice, by itself does not build endogenous capability. Endogenous capability can never be achieved if the capacity to generate knowledge is not established in the country. Centres of excellence have been playing a role of catalysts of technological progress in the history of development [22,23]. This concept can be used to promote photovoltaics in developing countries. The critical issue to be addressed is how to establish such centres in countries with weak industrial infrastructure and technical expertise. These centres are to be understood as a concept representing a system with human and infrastructural capabilities to undertake activities in the field of photovoltaics.

#### **5.4.4 The Ranges of Expertise of the Centres**

In broad lines, a full expertise in PV can be divided into the following levels [4]:

- . Level 1: How to put PV systems components together and keep them working; this level of expertise is needed in all localities where PV systems are installed;
- . Level 2: Design of PV systems from standard components; this level of expertise is necessary at national or regional scale;

. Level 3: Design and manufacture of some components of PV systems; this level of expertise gives a local capability in photovoltaics;

. Level 4: Production capability in PV, including modules and cells; this provides the basis for the dissemination of PV via national production provided that lower levels of expertise are in place and distribution and financing capabilities are developed;

. Level 5: Research, development and demonstration with commercialisation capabilities gives an endogenous capability providing that marketing functions are fully developed.

A national or regional centre should start its activities at the level of R&D&D. Such a centre can be more useful if it is a part of a national university, as in this way it can be easier to transfer the knowledge both through the normal teaching-learning process and through training courses. Since the constraints still hindering the promotion of PV are not only of a technological nature, an effective R&D&D programme should follow an interdisciplinary approach to the problem, looking at different relevant aspects, namely the economic and social issues.

After a successful establishment of a national or regional centre of expertise in photovoltaics, the next logical step towards the promotion of the technology in the country or region is to take it to the people who most need it: the rural dwellers. This can be effectively achieved through the involvement of the centre of expertise, together with other actors, in national programmes of dissemination of photovoltaics. This issue is presented in the next sections.

## **5.5 A Model for a Successful Dissemination of Photovoltaics in Mozambique**

A centre of expertise in photovoltaics can play a key role in promoting the dissemination of the technology in the country. Since in Mozambique such a centre has been established already, it is now opportune to look into effective strategies for the dissemination. The dissemination of any technology is a complex issue, as it involves a significant number of variables to be taken into account, some of which may vary substantially from technology to technology. There are nevertheless some common aspects to be considered in any dissemination activity, irrespective of the technology. The major ones are:

- . Public awareness of the technology;
- . Governmental support;
- . Strong involvement of the beneficiaries in all stages of project implantation.

Notwithstanding, the ways to materialise the above mentioned aspects are intimately linked with the specific technology being considered. This section deals with the elaboration of an appropriate methodology for an effective dissemination of photovoltaics in Mozambique. The parameters of paramount importance considered in this study refer to aspects of (i) dissemination mechanisms, (ii) technical support and (iii) financial arrangements, as detailed in the next subsections.

### **5.5.1 Dissemination Mechanisms**

In [3-4] it is pointed out that the dissemination of any product requires an organisational structure for the import or manufacture of the product, for its distribution, supply and maintenance. This supply chain can be achieved through the establishment of a free market for such a product. The dissemination of photovoltaics is essentially a marketing exercise and the criteria for success are similar to those for the successful introduction of any new product. As photovoltaics, like any renewable energy technology, is important for the national development as a whole, not only for



specific sectors of the society, its dissemination should benefit from a strong involvement of the government. The major role of the government should be that of facilitator and regulator. This role and those of the other players in the process of dissemination can be better clarified by considering the main market segments of photovoltaics in rural areas which, according to section 5.2, can be classified as follows:

- . Public services;
- . Private sector;
- . Individual users.

The dissemination process of any technology starts with demonstration, goes through its experimental application, ending with its final adoption. Each of the stages here presented has its own actors and it is an important issue to define correctly the right actors in each phase. The concerns of the government are different from those of the private sector or of individuals. The government takes a macro-economic view of the resources at its disposal, whilst other sectors are subject to micro-economic pressures. A macro-economic view would consider the total cost to the country of each energy technology and the comparisons would be made on the basis of these total costs. Such costs are not just monetary, but include factors such as the extent to which a technology increases or decreases the national dependence on imports, the environmental impacts and the extent to which particular technologies increase or decrease the divergence between rich and poor people and between urban and rural areas. Life cycle costing is the relevant method to compare different energy technologies. Most sectors of the society rarely use life cycle costing to compare products. The micro-economic pressure to choose a system with low capital cost, even if it is of higher life cycle cost, is at odds with the macro-economic goal of optimising the national energy supply. For the case of photovoltaics, in which the capital costs are indeed very high and the recurring costs very low, the intervention of the government

in dissemination is of paramount importance. On the other hand the government is regarded by banks as more credit worthy. Thus the government is the right institution to go ahead in promoting photovoltaics, installing systems to supply public services needs, like water pumping for community use in villages, systems for health centres, schools and administration offices. The Institute for Rural Development, in collaboration with the Eduardo Mondlane University (see appendix H for extension work undertaken), installed successfully a water pumping and a lighting system in a health centre in the province of Cabo Delgado, with a view to contributing to the creation of a critical mass of people to deal with this technology. The Ministry for State Administration has also been installing PV systems to power radio communication sets in rural administration offices, as a least cost solution to supply the required energy demands in such institutions. The Ministry of Health has the same plans for rural health centres. The Ministry for Co-ordination of Environmental Affairs is about to launch a large programme in photovoltaics, in the interest of protecting the environment. These are examples of activities which represent steps taken in a right direction for promotion of this technology. All these applications encompass both features of demonstration and experimental application of the technology. Local associations and other national organisations are welcome to join the efforts already initiated by government agencies. International organisations and aid agencies should support such initiatives, as renewable energies bring benefits not only at a national scale, but also at a global one, in terms of preserving the natural environment.

A successful demonstration activity would motivate other sectors of society to enter the market of photovoltaics. The rural private sector is likely to be the next group to use the technology, as photovoltaics offers opportunities to improve business activities in rural areas. Refrigeration of beverages in shops, lighting for entertainment, powering of music/television/video sets and battery charging are examples of that. There are some few people already using the technology for some of the purposes here

mentioned. The dissemination in this category can easily be made on a purely commercial basis, as in general the private sector has a relatively easy access to capital.

The last category to enter the market of photovoltaics would be that of individual users, which would benefit from the experience in projects run by the government and by the private sector. There are three main classes in this category. People of the higher class, who are very few, generally represented by major shopkeepers and farmers, would require full electricity services, as in a normal urban house. In fact, most of them use already diesel generators for electricity production. The medium class, generally comprising certain sectors of farmers and a few civil servants, would require electricity for lighting and for powering radio/music/television/video sets. The lower one, representing more than 90% of the rural dwellers, would be satisfied with home power systems for lighting and powering of radio sets. The dissemination should start with the higher classes and go gradually to the lower, or at least take place at the same time provided that the class structure is taken into account, in terms of types of products being disseminated. Surprisingly, most organisations involved in disseminating photovoltaics start the process at the lower classes. It is normal that any dissemination has to be based on a chain of imitative processes, and such processes have their flow from upper structures of the society to the lower. It is very unlikely that higher classes will be imitating the practices of lower classes. Therefore a dissemination starting at lower classes has very few chances, if any, of success.

### **5.5.2 Technical Support**

Any technological programme involves technical support. The national centre of expertise should have a key role in national programmes of dissemination of photovoltaics, as far as technical affairs are concerned. Its major tasks would be those of assisting governmental bodies at central level and providing training. For the execution of the dissemination strategy outlined in the above subsection, the long term maintenance and training requirements could be difficult to meet if only the resources

of the national centre were used. The users are a very important part of the dissemination. They have to perceive the technology as being of benefit to them and need to be well prepared in order to use it properly. Thus, the process of training by the national centre should be associated with a process of gradually building some local centres of expertise. Their major tasks would be those of (i) intermediating the process of acquisition of equipment by interested persons, (ii) training of users and (iii) assistance to the users in proper operation and maintenance of the equipment. Such centres should work in straight collaboration with the national centre of expertise. This process should have full support of the government and other organisations at its start, but they should ultimately become self-financing through the provision of services.

### **5.5.3 Financial Arrangements**

As photovoltaics requires high capital costs, the final crucial need is the organisation of financial structures which facilitate the purchase of photovoltaic products. In this case, as pointed out in [3-4], the government or community associations can play a role organising, through the banks, financing arrangements, similar to hire purchase, which transform the capital expenditure to a recurrent expenditure, and thus ensure that the micro-economic pressures conform to the macro-economic needs of the society. A particularly effective form of foreign aid could be to provide funds for banks to use in such loans, either as the initial capital in revolving loan schemes or as guarantees against bad debts [3-4]. Another urgent need for a widespread dissemination of photovoltaics is related to reduction of import taxes in renewable energy equipment. In fact, such taxes are higher than 50% of the product's price. It is meaningful for a primary need product, like photovoltaics in rural areas.

If the World Bank initiative of developing low-cost solar lanterns and chargers is successful, then there will be a case for saying that a widespread dissemination of photovoltaics will be very soon achieved. The target group of such systems represent more than 90% of the rural population. It is a class of people with very restricted

access to capital, for which very special financial arrangements would have to be provided.

## **5.6 Conclusions**

On the basis of end use and economic cost effectiveness analysis approach it was possible to determine that the energy question in rural areas should be approached in terms of decentralised supply systems. This is in accordance with the principle that concentrated energy supply systems, like those coming from great hydropower schemes or from diesel and coal power plants, are, from the technical point of view, most easily harnessed centrally and expensive to distribute, whilst dispersed energy supply systems, for instance solar, wind and micro/mini hydro systems, are most easily harnessed in dispersed locations and expensive to concentrate. In other words, the end use analysis undertaken here favours the local use of local resources. As a consequence biomass and new and renewable sources of energy have a very important role to play in rural development projects. Biomass will continue being the dominant fuel in applications like cooking and space heating. New and renewable energy technologies have experienced significant developments in the past decade, in terms of their reliability and cost, thus they are now at a stage that they can address end uses which were badly addressed by other supply systems and even enduses which had never been addressed before. Good quality lighting, telecommunications, vaccines refrigeration in health clinics, video/television programmes and electricity experiences in schools are some examples of this. For the specific climate of Mozambique and of other many Southern African Countries photovoltaics has a major role to play, as solar energy is the most reliable energy resource in the region. Photovoltaics, particularly, can have a major impact in water pumping and lighting applications in the rural context. Other important applications can be in health, education and telecommunications.

The developmental objective of the research programme whose results are presented here was to contribute for a technology transfer of photovoltaics to Mozambique, in particular. Thus the building of capacity in the design, assembly and operation of photovoltaic systems for various enduses was a major aim. Other aims included the building of capacity in economic and social analysis linked with the use of energy systems. With the capacity created, whereby a significant number of manpower and infrastructures were built, it can be stated with every confidence that a centre of expertise in photovoltaics has been created in the country. The centre has its major expertise in the following fields:

- . Technology deployment issues;
- . Evaluation of the potential of energy technologies;
- . Policy studies.

The centre has been receiving a significant number of enquiries to give its contribution in the areas above mentioned.

The last five years have been characterised by a rapid growth in application of photovoltaic technology. The Solar World Programme to be launched in 1996 by UNESCO will very probably contribute to a higher growth. As a consequence, there will be a need in developing countries, and in Mozambique in particular, to manufacture locally some components of photovoltaic systems, instead of importing everything as is the situation now. In order to respond to that need this research programme should be continued and expanded to incorporate the creation of expertise in the manufacture of photovoltaic systems components. The PV systems components comprise two categories:

- . The balance of systems (BOS) components and
- . The solar cells and modules.

BOS components comprise the whole range of the conventional part of PV systems, this means batteries, electronic regulators, inverters, lamps and pumps, among others. The continuation and expansion of the research programme now finished should firstly focus on these components. Solar cells and modules represent the non-conventional part of a PV system. The analysis of the developments in the technologies of solar cell fabrication shows that there is still a long way to go until stabilised and cost effective fabrication processes will be reached. Nevertheless, technologies of thin films discussed in this document will enable easier processes of fabrication, suitable for mass production, and eventually such manufacturing processes can be developed also in countries with a weak industrial capability and technical expertise, like Mozambique. Therefore the creation of expertise in solar cells/modules should be the ultimate goal to be achieved. This is important if a sustainable promotion of photovoltaics is envisaged.

An overall assessment of the work presented throughout this dissertation reveals that an independent and original contribution to knowledge has been made, especially in:

- . Undertaking the first application and analysis of the photovoltaic technology in Mozambique;
- . Undertaking an economic analysis of the technology appropriate to local conditions;
- . Formulating the requirements for innovative technological development in new “centres of expertise in photovoltaics” for the technology transfer;
- . Undertaking a survey of the village requirements in photovoltaic solar energy services in Mozambique.

A chronology of activities undertaken in the framework of this research programme is presented in appendix I.

## References

[1] A. J. Yager and N. J. Salvador "SADCC Strategy for the Use of NRSE Technologies by the Electric Power Utilities", Proceedings of the 11th EC PVSEC, October 1992, Pages 1621-164.

[2] F. C. Marques and I. Chambouleyron "The Role of Silicon Solar Cell Fabrication in Intermediate Level Training", Progress in Photovoltaics, Volume 1, January 1993, Pages 79-81.

[3] R. Hill "Photovoltaics in Developing Countries", Proceedings of the 9th EC PVSEC", Freiburg, September 1989.

[4] R. Hill "Organisation and Training Needed for the Development of Endogenous Capabilities in Photovoltaics", ATAS Bulletin, UN Publications, New York, Volume 8, 1993.

[5] Barry Munslow "Mozambique", in Energy, Environment and Development in Africa, Band 4, Edited by Phil O' Keefe and Barry Munslow, 1984.

[6] Barry Munslow et al "The Fuelwood Trap: A Study of the SADCC Region", London, 1988.

[7] Mozambique: Energy Sector Strategy, World Bank Report, Department of Energy, Maputo, 1995.



- [8] Andrew C. Millington et al. "Estimating Woody Biomass in Sub-Saharan Africa", The World Bank, Washington D.C., 1994.
- [9] Sam Moyo, Phil O'Keefe and Michael Sill "The Southern African Environment", Earthscan Publications Ltd, London, 1993.
- [10] Wind and Solar Energy Resources in the SADCC Region, SADCC Energy Sector, Technical Administrative Unit, Luanda-Angola, 1991.
- [11] Phil O' Keefe "Photovoltaics for Development: Identifying Real Opportunity", in Applications of Photovoltaics, Edited by R. Hill, Adam Hilger, 1989.
- [12] F.Lasnier and T. G. Ang "Photovoltaic Engineering Handbook", Adam Hilger, 1990.
- [13] Fax message from the World Bank to the Department of Energy in Mozambique, December 1995.
- [14] Robert Hill, Phil O'Keefe and Colin Snape "The Future of Energy Use", Earthscan Publications Ltd., London, 1995.
- [15] A. Ricaud "Photovoltaic Commercial Modules: Which Product for what Market?", Proceedings of the 12th EC PVSEC, Amsterdam, The Netherlands, April 1994, Pages 7-14.
- [16] A. Derrick, R. W. Barlow, B. Mcnelis & J. A. Gregory (Editors) "Photovoltaics: A Market Overview", James & James Science Publishers Ltd., 1993.

- [17] R. Hill et. al. "The Successful Implementation of Photovoltaics in Developing Countries", Proceedings of the 12th EC PVSEC, Amsterdam, The Netherlands, April 1994, Pages 2004-2007.
- [18] Science, Technologie et Développement Endogène en Afrique - CASTAFRICA II, UNESCO, 1985.
- [19] S. C. Trindade, Proc. Euroforum - New Energies Congress, Volume 33, 1988, Pages 79-.
- [20] Abdus Salam "Notes on Science, Technology and Science Education for the Development of the South", TWAS, 1988.
- [21] H. Lopes "National Assessment of New and Renewable Sources of Energy (NRSE), SADC", Mozambique, Maputo, 1989.
- [22] Abdus Salam "Science in the Third World", The First Edinburgh Medal Address, Edinburgh University Press, 1989.
- [23] B. C. Cuamba, R. Hill, Phil O'Keefe, N. M. Pearsall and A. Derrick "Building a Centre of Expertise in Photovoltaics in Mozambique", Proceedings of the 12th EC PVSEC, Amsterdam, The Netherlands, April 1994, Pages 2024-2027.

## **Appendix A: List of Abbreviations**

AC - Alternating current.

a-Si - Amorphous silicon.

ATAS - Advanced Technology Assessment System (UN Publications).

BOS - Balance of System.

BP - British Petroleum.

CIF - Cost, Insurance and Freight.

DC - Direct Current.

eV - Electron-Volt.

EXP - Expenditure.

I - Current.

INC - Income.

IPE - Institute of Physical Electronics at Stuttgart University, Germany.

IT Power - Intermediate Technology Power

MI - Swedish Institute of Microelectronics.

NGO - Non Governmental Organisation.

NPV - Net Present Value.

NREL - The National Renewable Energy Laboratory, Colorado, USA.

PC - Personal computer.

PV - Photovoltaics.

RIT - Royal Institute of Technology, Stockholm, Sweden.

SADC - Southern African Development Community.

SIDA - Swedish International Development Agency.

T - Temperature in Kelvin.

V - Voltage.

## **Appendix B: Glossary**

### **Photovoltaic conversion:**

The technology enabling direct conversion of sunlight into electricity.

### **Photovoltaic cell:**

A semi-conductor device, made of either for example silicon, cadmium telluride and copper indium diselenide, which converts solar radiation into electricity by absorption of photons in one or more layers of material. The photons convey their energy to the electrons of the semi-conductors and create free electrons and holes, which can flow as an electric current in an external circuit.

### **Photovoltaic module:**

Assembly of cells connected together electrically in series and/or in parallel depending on current and voltage to be obtained, and assembled mechanically so as to form an integrated unit. They are insulated against moisture by one, or in extreme cases, by several layers of polymer and glass encapsulation materials, and fixed into a frame for mechanical strength.

### **Photovoltaic array:**

Assembly of modules connected together electrically in series and/or in parallel depending on current and voltage to be obtained, and assembled mechanically so as to form an integrated unit. Generally the modules building an array rest on a support structure in most cases made out of aluminium or steel struts, resting on a concrete foundation or on buildings (e.g. roof).

**Efficiency:**

The relationship between the electric energy supplied by a device and the energy coming into that device. A cell, for instance, has an efficiency defined for irradiation of  $1 \text{ kW/m}^2$ , a reference spectral distribution of AM 1.5 and a cell temperature of  $25^\circ\text{C}$ .

**Peak power or Watts peak ( $W_p$ ):**

Units of measurement of power cell or module under reference conditions ( $1 \text{ kW/m}^2$ , AM 1.5,  $25^\circ\text{C}$ ).

**Crystalline material:**

Solid material, the atoms of which are distributed in a regular network which is periodical and well defined. The technology of production of silicon cells, for instance, necessitates the growing of ingots of silicon from which wafers with a thickness of 200 to 500 micrometres are then cut.

**Amorphous material:**

Solid material in which the atoms are distributed in a random manner, without any defined order. The production of solar cells through this technology uses a thin layer deposit of the defined order of 1 micrometre.

**Balance-of-system components:**

All components of the system together, besides the modules, are called the balance-of-system (BOS). The composition of the balance-of-system depends on the kind of application and on the location of the photovoltaic system. The balance-of-system comprises array support structure, connections/wiring, power conditioning and energy storage.

**Regulator:**

Electronic device making it possible to limit any overloads or discharges which are too great for the accumulator batteries. When a battery is approaching its saturation level, the supply coming from the solar modules is progressively cut so as to limit the loss of electrolyte and thus ensure the longest possible battery life. When the state of charge is low, the regulator progressively cuts off the supply to the users, according to a predetermined priority so as to prevent any premature sulphation of the electrodes.

**Inverter:**

Electronic device for producing alternating current at the expected conditions of that supplying the urban network, using direct current from the solar cells or batteries.

**Photovoltaic power plant:**

System composed of modules connected in series and/or parallel so as to obtain the voltage and current desired and a load. It may also have an accumulation system, intended to supply the needs steadily, whatever fluctuations may occur in solar radiations, a regulation system which makes it possible to optimise the performance of the system, one or more inverters transforming the direct current coming from the array or batteries into alternating current. Generally it contains the customary protective devices on all energy generators (cut-out switches, fuses, lightning conductors, etc.).

**Capital cost:**

The cost of construction, including design costs, land costs and other costs necessary to build a facility. This does not include operating costs.

**Amortisation:**

The recovery of investment expenditure by means of annual returns.

**Amortisation period:**

The period needed to recover the capital invested in an investment project from the returns discounted at an appropriate rate. Also pay-back period.

**Capital recovery factor (CRF):**

The factor used to calculate the amount of regular payments needed to recover a present value at a given interest rate over a specified time period.

**Cash flow:**

A cash flow is the difference between total cash receipts (inflows) and total cash disbursements (outflows) for a given period of time (typically one year).

**Depreciation:**

The periodic reduction in the value of the capital goods assets connected with an investment.

**Interest rate:**

The cost of borrowing money.

**Discount rate:**

The opportunity cost of making an investment.

**Discounting:**

The reduction in the value of a future payment calculated at a given discount rate to establish its present value.

**Discounting factor:**

The factor for calculating the present value of a single future payment accounting for the time and at a given discount rate.

**Compounding:**

The increase in the value of a past payment by regularly compounded interest to establish its present value.

**Inflation:**

The process of general price expansion.

**Inflation rate:**

The increase in the general price level as a percentage of the previous year's prices.

**Present Value:**

The value of a future amount discounted or a past amount compounded over a specified time period at a specified discount rate.

**Net present value (NPV):**

The sum of the present values of all cash flows connected with a particular investment project over its lifetime.

**Present value factor (PVF):**

The factor used to calculate the present value of a sequence of equal payments or cash flows occurring at regular intervals over a specified time period and at a given interest rate.

**Opportunity costs:**

The fictitious costs which correspond to the income which might be expected from an alternative application of scarce resources. They are also referred as "shadow prices".



**Return:**

The excess of the income in a period (usually one calendar year) over the running costs.

**Profitability:**

The return on investment.

**Service life:**

The period during which an investment facility should or will be used economically. The service life can be shorter than the technical lifetime; however, it is usually assumed that the technical lifetime and service life are equal.

**Sensitivity analysis:**

An investigation during an investment evaluation with the aim of determining the sensitivity in a financial indicator following a given variation in a project input parameter.

**Liquidation yield:**

The income expected by the sale of assets at a fixed point in time, usually at the end of the service life.

**Technology transfer:**

A transaction between at least two parties, the transmitter and the receiver, in a process of acquisition of machinery, equipment and factories, also called hard technologies. Each partner has its responsibilities in the transaction. For this to be successful it is important that the transfer of hard technologies be accompanied by complementary soft technologies, such as expertise, organisation, management methods, maintenance and R&D&D capacities.

**Technology dissemination:**

A guided way, through the Government, Governmental and Non-governmental organisations, of promoting the use of a technology, whereas diffusion of a technology refers to a mechanism which has no apparent intervention.

**Centre of expertise:**

A concept representing a system with human and infrastructural capabilities to undertake specialised activities.

**Sustainable development:**

A development that aims at satisfying the needs of the present generations, but without preventing the future generations to supply their needs.

## **Appendix C: Major Suppliers of PV Water Pumping Equipment**

BHEL  
PV Division  
Vikasnagar  
Mysore Road  
INDIA

Mono Pumps Pty. Ltd.  
338-348 Lower Dandenong Road  
Mordialloc  
Vic 3195  
AUSTRALIA

BP Solar International  
36 Bridge Street  
Leatherhead  
Surrey  
KT 22 8BZ  
UK

Neste/NAPS  
P O Box 96 Riuklokka  
Brobekkveien 101  
N-0516  
Oslo 5  
NORWAY

BP Thai Solar Corporation Ltd.  
101/47/9 Nava Nakorn's Ind.  
Estate  
Phaholyothin Road, Klong 1  
Klong Luang  
THAILAND

Photowatt International S.A.  
131 Rt de l' Empereur  
92500 Rueil-Malmaison  
FRANCE

CEL  
4 Industrial Area  
Sahibabad 201 010  
UP  
INDIA

Photowatt International S.A.  
65, Av. du Mont Valerien  
92500 Rueil-Malmaison  
FRANCE

Chloride Solar Ltd.  
Lansbury Estate  
Lower Guildford Road  
Knaphili  
UK

R&S Renewable Energy Systems  
P O Box 45  
5600 AA Eindhoven  
THE NETHERLANDS

Dinh Company  
Box 999  
Alachua  
Florida 32615  
USA

REIL  
D-37 Madho Singh Road  
Bani Park  
Jaipur 302006  
INDIA

Duba S. A.  
Nieuwstraat 31  
B-9200  
Wetteren  
BELGIUM

Siemens Solar GmbH  
Buchenallee 3  
D-5060, Bergisch Gladbach  
GERMANY

Fluxinos  
58100 Grosseto  
Via Genova 8  
ITALY

Société Nouvelle Chronar  
3 Allee Edme Lheureux  
Immeuble Vancouver  
94340  
FRANCE

Grundfos  
DK-8850  
Bjerringbro  
DENMARK

Solar Energie Technik  
Postfach 1180  
D/6822 Altusheim  
GERMANY

Heliodinâmica  
Caixa Postal 8085  
9051 São Paulo - SP  
BRAZIL

Solarex Corporation  
1335 Piccard Drive  
Rockville  
MD 20850  
USA

Helios Technology  
Via PO 8  
Galliera 1-35015  
Veneta (PD)  
ITALY

Solarex Pty. Ltd.  
78 Bibela Street,  
Villawood  
P O Box 204  
AUSTRALIA

Hydrasol  
Industriestrasse 100  
6919 Bammental  
GERMANY

Solar Jack International  
c/o Energy Tech  
13901 North 73rd street  
Scottsdale  
Arizona 85260  
USA

IBC  
P O Box 1107  
D-8623 Staffelstein  
GERMANY

Southern Cross Int.  
Box 454  
Toowoomba  
Queensland  
AUSTRALIA

Intersolar Ltd.  
Factory Three  
Cock Lane  
High Wycombe  
UK

Suntron  
2/861 Doncaster Road  
Victoria 3109  
AUSTRALIA

Italsolar  
Via A. D'Andrea, 6  
Nettuno 00048 (RM)  
ITALY

Telefunken System Technik GmbH  
Industriestrasse 23-33  
D-2000 Wedel  
Holstein  
GERMANY

KSB Pumpen  
D-6710  
Frankenthal (Pfalz)  
GERMANY

Total Energie  
24 Rue Joannes Masse  
69009 Lyon  
FRANCE

Kyocera  
Chiba-Sakura Plant  
4-3 Ohsaku 1-Chome Sakura-Shi  
Chiba-Pref 285  
JAPAN

Zome Works Corporation  
P O Box 25805  
Albuquerque  
NM 87125  
USA

A Y Macdonald Manufacturing Co  
4800 Chanvenelle Road  
Dubuque  
Iowa 52001  
USA

Mono Pumps Ltd.  
Cromwell Trading Estate  
Bredbury  
UK

Source: Roy Barlow, Bernard McNelis and Anthony Derrick "Solar Pumping",  
Intermediate Technologies Publications and The World Bank, Washington, D.C.,  
1993.

## **Appendix D: The Methodology of Designing a PV Water Pumping System**

The design of any PV pumping system starts with site and system evaluation. The end result of a site evaluation is to answer the question "What type and size of solar pump is best suited to the site, and what will its capabilities be?" for a given situation. This must include all aspects from the assessment of water demand and resource availability, to sizing of the various components of the pumping system. This appendix aims to give a practical means of estimating the various system parameters for a given scenario. All manufacturers will use their own sizing methods that are suited to their particular products. Therefore this is simply a methodology for an approximate sizing, to give the user some idea of the feasibility of solar pumping for his situation and of what to expect in terms of hardware requirements. The requirements of village water supply and irrigation pumping are very different. This appendix covers only village water supply. There are three main technical factors that act as boundary conditions to the problem of site evaluation, and of which it is necessary to obtain realistic estimates. These are:

- (i) The demand for water;
- (ii) The availability of water;
- (iii) The solar resource.

Although the solar resource can be quite reliably defined, the assessment of the demand for water and the availability of that water can present serious difficulties. Factors such as seasonally changing village populations and water tables and the relationship between well drawdown and pumping rate introduce unknown quantities that will complicate what at first glance may seem a simple problem. In addition, experience in West Africa has shown that following installation of a solar pump

populations can double almost overnight. The concept of demand is not always valid at all, as in many situations the limiting factor will be the production capacity of the well. In this case a good procedure is to try to estimate what supply can be provided by such a well and to decide if this still justifies installation of a solar pump.

### **1. Physical System Layout**

At this point consideration must be given to the physical layout of the system. This will be dictated by the water source and the layout of the village. For village water supply, the water source will almost certainly be a dug well or borehole. To this end, determine the most logical positions of the borehole or well and the storage tank in relation to the point of use, and find a rough estimate for the lengths of piping that will be necessary. For a medium depth borehole the appropriate pump type is a submersible centrifugal pump.

In general pipework is produced locally. Typical pipe diameters may be 50 to 150 mm. If the pipes are too narrow the increased dynamic head will mean that a larger array is needed (this is the additional head requirement due to friction and turbulence within the pipework). Pipes are cheaper than PV modules, thus pipes should be oversized such that head loss is minimal. The usual configuration for a village water supply network would be to place a storage tank close to the pump. Thus when calculating the total pumped head it is to consider the pipework as far as the tank. This is because it is the tank and not the pump that provides the head for the distribution system. The height of the tank has to be calculated considering the distribution/stand-pipe system. Local constructors have experience on this. The size of the tank is determined by how many days storage are wanted. Around five days is desirable if there is no other source of water, but two to three days is likely to be common. Hence at a later stage in the calculation, when the average daily supply has been found, the tank volume is found by just multiplying the daily demand by the number of days storage capacity.

## 2. Groundwater Resources

The most likely limiting factor on the amount of water that can be pumped will be the availability and depth of groundwater. Some boreholes or wells drilled for village water supply have only enough capacity to use a handpump ( $<2\text{m}^3/\text{hour}$ ) because they cannot refill fast enough. As water is pumped from a borehole, the water table will drop below that of the surrounding water table. It is the resulting head difference, known as the drawdown, that causes water to flow into the well through its walls. As the pumping rate is increased, the drawdown also increases, until a point is reached where the well is emptied out. A lesser pumping rate, which can be sustained, must therefore be selected, such that the in-flow through the walls equals the outflow, with several metres of water still in the bottom of the well. This is the maximum sustainable pumping rate and will be used as an upper limit for design purposes. The exact relationship between the drawdown and the pumping rate will depend on the diameter and total depth of the borehole and the permeability of the rock or soil. In situations where the water table is found in shallow sandy soil, say near a river or lake, the water is essentially submerged surface water. The abundant supply and highly permeable soil will mean that drawdown will be relatively small in these cases. In areas where boreholes must be sunk into deep aquifers below caps of impermeable rock, the drawdown will be very much larger for the same pumping rate, and may form a significant part of the total head. Thus without including drawdown in the analysis there is a danger of under-sizing the pump, as the real water level in the well, once pumping begins, may be well below the static water table. Even more serious is the danger of over-sizing the pump. If during the sunniest part of the day the pumping rate is too high the water level may drop below the level of the pump intake and the pump will free-run. This may cause the motor of the pump to overheat and burn out in quite a short time, although now most manufacturers provide a cut-out to prevent dry-running. Although it is never possible to exactly predict the drawdown relationship before drilling, some idea of its extent can be gained from data from neighbouring wells, or, if an existing well is being used, from the driller's records. When a borehole



is drilled, a test should be performed by using a diesel pump to pump out water at certain rate and measure the drawdown when a steady state has been reached. The maximum safe rate and the corresponding drawdown should be recorded. Seasonal changes in the depth of the static water table must also be taken into account. They will be more pronounced in submerged surface water situations, and depths can vary by up to 10 m in some places. The level in deep aquifers tends to remain more constant. For practical purposes monthly data are desirable.

### **3. The Solar Resource**

The daily energy that a PV array is capable to produce is dependent on the intensity of the sun throughout the day and on the size of the array capturing that energy. Hence it is important to know about the availability of solar energy at the site in question. The quantity of interest is a measure of the total solar energy over a whole day. This is called the insolation and is usually expressed as a daily energy per unit area, in general expressed as kWh/m<sup>2</sup>. The insolation is a quite well defined quantity, and will not be greatly subject to local variations. Ideally, month by month solar radiation data are required in order to properly assess the suitability of a site for a solar pump. It is not sufficient to size a pump on the basis of annual solar data, as sufficient water may not be provided in months of low solar insolation. If possible, data should be obtained from the nearest meteorological station, and allowance made for any known local variations in sunshine.

In theory an array tilted at the latitude angle gives the best mean annual solar energy collection. The tilt angle is defined as the angle at which the array is raised from the horizontal, and is measured with array pointing south in the northern hemisphere and north in the southern hemisphere.

#### **4. Water Requirements**

Domestic water requirements vary markedly in response to the actual quantity of water available. For example, the average domestic consumption in western Europe and the USA is between 100 and 150 litres per day, per person. At the other end of the scale the level in rural areas of developing countries varies between about 5 and 35 litres per day, per person. In severe conditions many people survive near the biological minimum of 2 litres per day. The World Health Organisation (WHO) defined 40 litres per day and per person as a short term goal for the developing world.

#### **5. Array Sizing**

The size of the array and pump depends on the daily solar insolation and hydraulic energy requirement, which will be expressed as the volume-head product. This is simply the daily pumped volume multiplied by the total pumped head. This must be calculated for each month, and the month that requires the largest array size is called the design month. This is so called because it is the "worst-case" and represents the extreme conditions to design for. If the pumping system can meet the requirements in this month, then it can, by definition, meet them in every other month.

The equation for sizing an array is given by:

$$W = (1000.VHP) / (367.I.e), \quad (1)$$

where  $W$  is the array rating in  $W_p$ ,  $VHP$  is the volume-head product in  $m^4$ ,  $I$  is the daily insolation in  $kWh/m^2$  and  $e$  is the subsystem daily energy efficiency expressed as a fraction.

#### **6. Motor/Pump Sizing**

The motor and pump are usually one composite unit, and so are already mechanically matched. The motor must be rated high enough to withstand the peak output of the

array, and as motors are generally rated in terms of their maximum electrical input power, this must at least be equal to the array  $W_p$  rating. By arranging the PV modules in series and parallel, the array can be configured to match the motor voltage and current limitations. The type of motor and pump is defined in accordance with the array size and borehole data.

### 7. Pipework Sizing

Once the array size to be used is known it is possible to calculate the predicted peak flow rate required. This can be obtained from the peak hydraulic power produced and the head. The peak hydraulic power produced by the pump is given by the product of the peak array power output and peak subsystem efficiency. Information on dynamic head loss due to pipe friction as a function of flow rate is given in figure below.

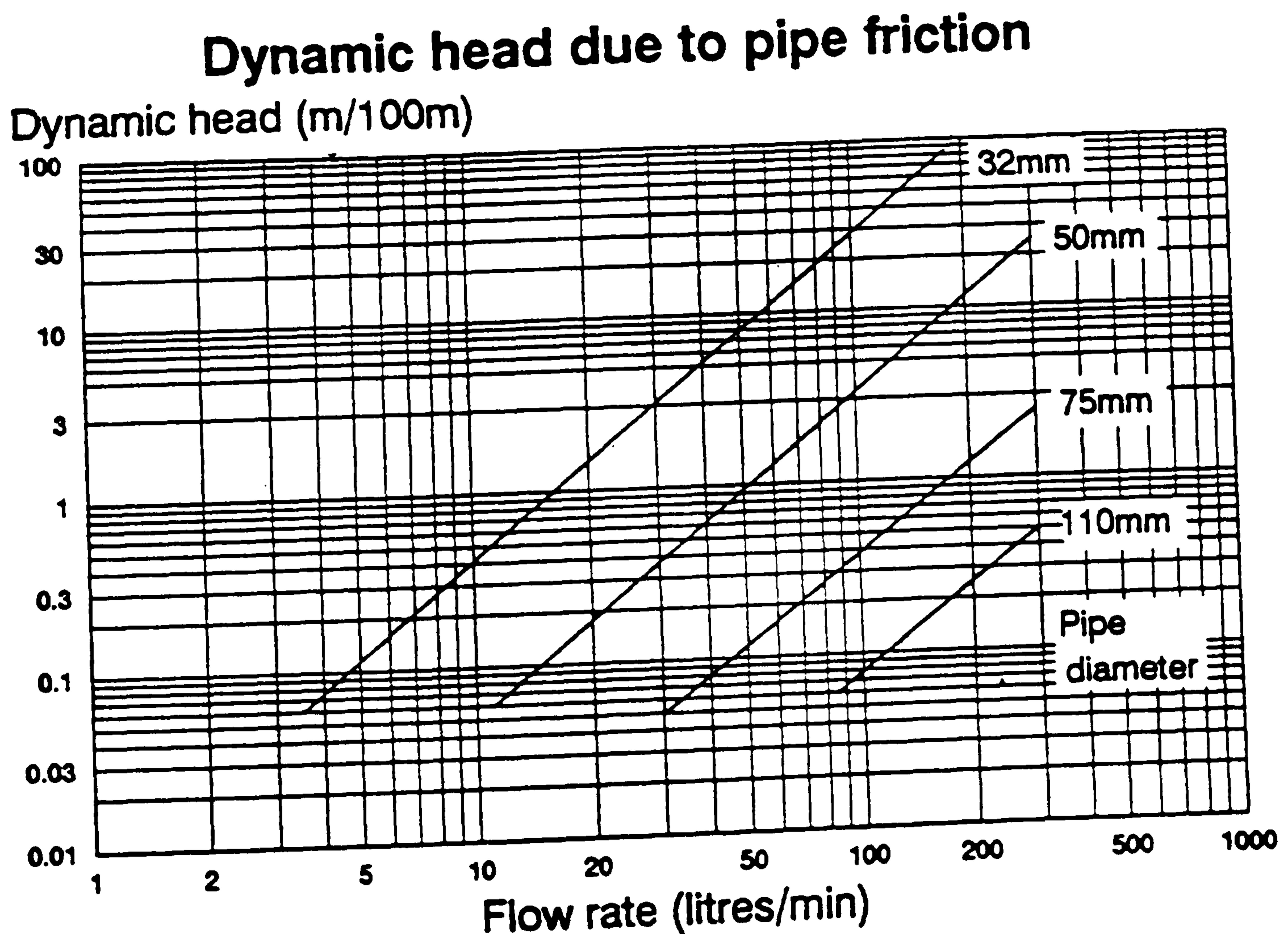

Figure: Frictional head loss as a function of flow rate.

## 8. Estimating Performance

It must be remembered that the sizing has been done for the worst case month, and does not represent the typical operating conditions. It is not absolutely necessary to calculate the water output in the remaining 12 months, because it is known that if the pump can meet the worst case, then it can cope all year round. However, it may be useful or interesting to know what the approximate output will be all year round, and this can be found in the following way:

$$VHP = (367.W.I.e) / (1000). \quad (2)$$

Dividing VHP by the total head, the daily volume of pumped water can be obtained.

## 9. Example

Let take the case of the system considered in this dissertation as an example.

**9.1 Determination of total head** - The water is pumped from a borehole, with a static water table of 28 metres. The drawdown is of 8 metres. The height from the surface up to the top of the tank is of 6 metres. If the dynamic head is neglected, then the total head is of 42 metres.

**9.2 Determination of daily water demand** - The system has been designed to supply drinking water to a community of 250 people, consuming each person 40 litres per day. This means that a total of 10,000 litres per day are necessary.

**9.3 Determination of design month** - Considering the data of monitoring presented in chapter 3 of this dissertation, the month with the lowest daily average solar radiation is June, with 3.35 kWh/m<sup>2</sup>/day. Thus June is the design month, and the value of insolation presented should be used for sizing purposes.

**9.4 Determination of array size** - The array size can be determined using expression(1), with a daily motor/pump subsystem of 35%. Its value is of:

$$W=976 W_p.$$

**9.5 Determination of motor/pump size** - Now the size of the motor/pump unit can be determined. Of particular importance is the definition that a AC motor has to be used, and thus an inverter, as the power rating of the array is much greater than  $250 W_p$ . On the other hand, the motor/pump subsystem has to be a submersible one, as for medium borehole depths is the best choice.

**9.6 Procurement of Equipment** - After determining the size and type of the system, the process of procurement can start, looking for manufacturers which are active on the type and rating of equipment. In this case, there are a lot of manufacturers supplying submersible motor/pump units at the wattage defined, e. g. Grundfos, BP Solar, Heliodinâmica and Kyocera. It is important to understand that the sizing methodology presented gives an approximate value of the size of the system. The information used for sizing has to be given to suppliers in order for them to size more accurately the system, in accordance with the specificities of their equipment.

Source: Roy Barlow, Bernard McNelis and Anthony Derrick "Solar Pumping", Intermediate Technologies Publications and The World Bank, Washington, D.C., 1993.

## **Appendix E: Description of the Main Plant's Components**

### **The PV Array**

The PV array comprises 2 parallel strings composed of 8 flat-plate series modules of type M55 each, manufactured by Siemens Solar Ltd and purchased in 1993. The maximum power of each module at standard test conditions was of 53  $W_p$ , the open circuit voltage ( $V_{OC}$ ) of 21.7 V and the short circuit current ( $I_{SC}$ ) of 3.35 A. The voltage and the amperage at load were of 17.4 V and 3.05 A, respectively. Each module contained 36 single-crystalline cells with 102.9  $cm^2$  each, all connected in series. Each module, with dimensions of 1293mmX330mm, contained a bypass diode, which protected the module against reverse biased currents. The whole PV array was suitably grounded in order to protect it from indirect lightning strikes. The array was supported by a stainless structure in a concrete foundation, with a capacity to withstand winds with speeds up to 200 km/h. The array had a fixed tilt angle of 30° and was installed facing the north.

### **The Inverter**

A Grundfos inverter of type Solartronic SA 1500, purchased in 1993 together with the whole system, was used in this research. Its main function was to convert the DC power from the PV array into three-phase AC power, in accordance with the requirements of the Grundfos motor used. It is a frequency variable inverter, specially designed for use in connection with a PV array. The inverter incorporated a built-in power electronic interface unit, whose functions were: (i) to step-up the array voltage and (ii) to track the working-point to the peak-power-point. The input nominal load voltage of the inverter was of 120 V DC, allowing a maximum of 140 V DC and a minimum of 100 V DC, for its normal operation. Outside this range the stepping up and tracking capabilities do not work correctly.

### **The Motor-Pump Unit**

The submersible motor was direct coupled underneath the pump so that the motor and the pump formed a complete unit, and classified as of type SP3A10. All vital parts of both motor and pump were manufactured from stainless steel. Both components were manufactured by Grundfos and purchased in 1993. The motor, a frequency variable one, of type MS 402, was a 2-pole asynchronous squirrel-cage motor of the canned type with slide bearings. The pump was a multistage centrifugal pump with radial impellers. The pump itself had water lubricated rubber bearings. The discharge chamber was internally threaded and designed with a non-return valve.

### **The Storage Tank**

A storage tank with a capacity of 5 cubic meters has been used in connection with the power plant. It was manufactured by a local company (Forjadora, E.E) in 1992. It was made of steel and its dimensions were 1.5 m of diameter and 3 m of height. The whole tank was over a support structure of 3 m height. The main function of the tank was to serve as a back-up for the irrigation application, avoiding low water pressures associated with low levels of irradiance, especially early morning and late afternoon as well as in cloudy days. The tank was equipped with a return valve to allow water to flow back to the bore hole if it was not used.

### **The Borehole**

The water was pumped from a bore hole of 55 m depth and 6 inches of diameter, drilled by a local company (Geomoc, E.E.) in 1992. The sequence of geologic layers found is as follows:

- (i) fine sand from the top to 40 metres;
- (ii) clay from 40 to 45 metres;
- (iii) medium sand from 45 to 53 metres (it is in this layer that groundwater is collected);

(iv) clay from 53 to 55 metres.

The borehole walls were of a closed steel pipe, from the top of the borehole up to a depth of 45 metres. This arrangement is made in order to avoid infiltration from contaminated waters coming from surface into the borehole. From the depth of 45 metres to 53 metres, a ripped steel pipe (filters) has been used. From 53 metres to the bottom a closed steel pipe has been used again, as a measure to impede infiltration of clay particulates into the borehole. Testing the borehole by means of a diesel pump, its static and dynamic levels were determined as 28m and 36 m, respectively, for a pumping flow of about 2 m<sup>3</sup>/hour.

The water from the borehole has been analysed by the National Laboratory for Hygiene and Water at the Ministry of Health and it has been qualified as appropriate for drinking.



## Appendix F: Costs of Equipment and Services

Description of Equipment/Service	Costs in US\$
PV array with support structure	10,200
Inverter	900
Motor/pump unit	900
<b>Subtotal</b>	<b>12,000</b>
Drilling of the borehole (labour and material)	2,200
Manufacture of the tank (labour and material)	1,300
Installation of the whole system (estimated)	800
Fencing	300
<b>Subtotal</b>	<b>4,600</b>
<b>General Total</b>	<b>16,600</b>

# Appendix G: The Map of Mozambique

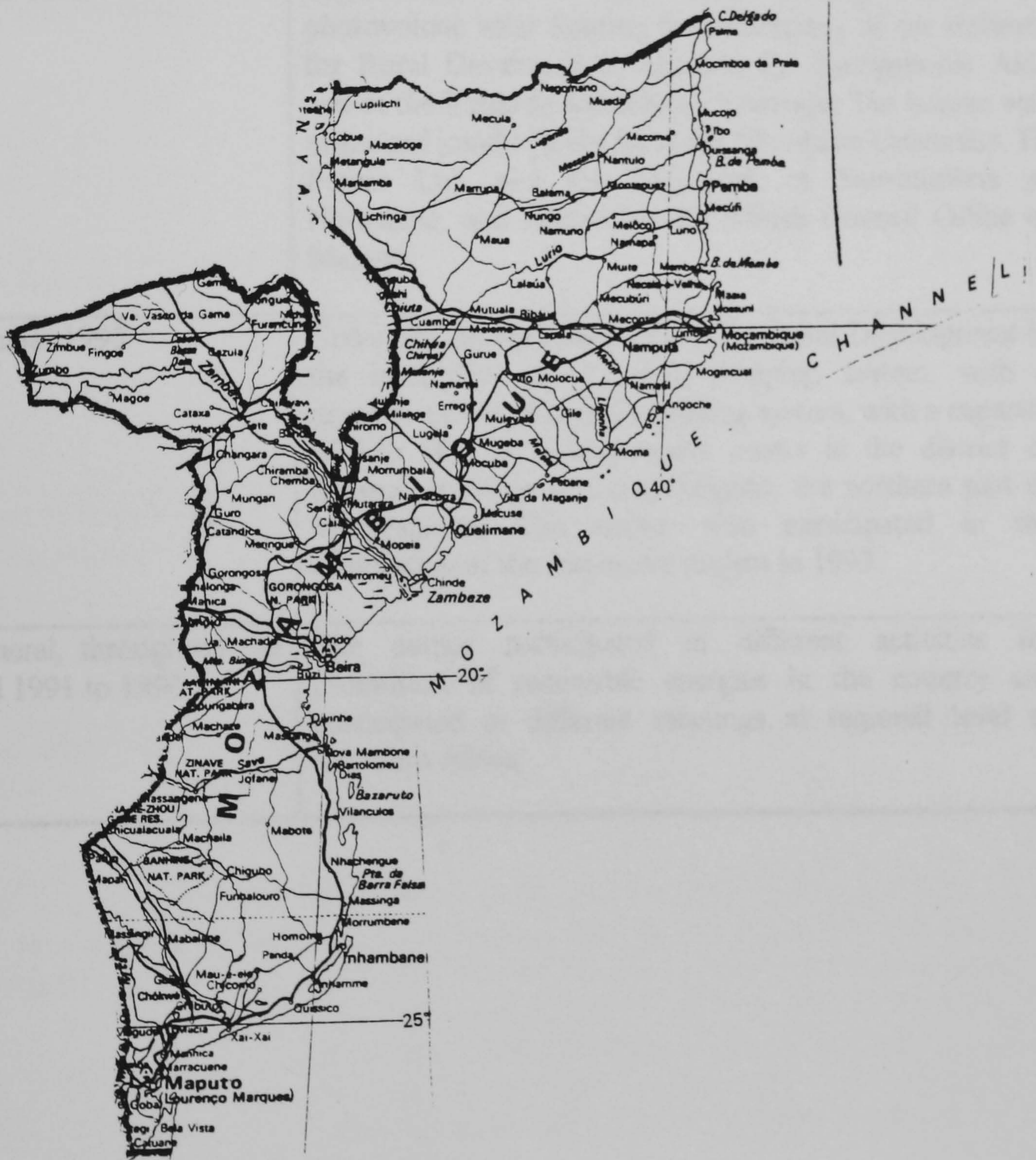

## Appendix H: Extension Work Undertaken

Period	Type of Activity
October 1993	Organisation of a one week training course on photovoltaic solar lighting for technicians of the Institute for Rural Development, Institute for Navigational Aids and of the Eduardo Mondlane University; The course was organised jointly by the Eduardo Mondlane University, IT Power Ltd. and the University of Northumbria at Newcastle, and funded by the British Council Office in Maputo.
September 1995	Collaboration with the Institute for Rural Development in the installation of a water pumping system, with a capacity of 742 Wp, and a lighting system, with a capacity of 159 Wp, in a rural health centre in the district of Balama, province of Cabo Delgado, the northern part of Mozambique; The author also participated in the elaboration of the respective project in 1993.
In general, throughout the period 1991 to 1996	The author participated in different activities for promotion of renewable energies in the country and participated in different meetings at regional level of Southern Africa.

## Appendix I: Chronology of Activities

Period	Activities
January to April 1991 (In UK and Portugal)	Studies on PV science and technology, including the elaboration of a project conception on PV water pumping, at the University of Northumbria at Newcastle; Formal registration for the degree of MPhil with transfer possibility to Ph.D. at this University. Participation at the 10th EC PVSEC in Lisbon, Portugal.
May to December 1991 (In Mozambique)	Elaboration of a project on PV water pumping submitted to the Swedish organisation SIDA; The project was approved by SIDA in December 1991; Continuation of studies on PV science and technology.
February to March 1992 (In Mozambique)	Continuation of studies on PV science and technology; Selection of site for the installation of an experimental PV pumping facility; A site was identified at the main campus of the Eduardo Mondlane University.
April to July 1992 (In UK)	Studies on economics of energy projects and end use analysis, at the University of Northumbria at Newcastle.
August to December 1992 (In Mozambique and Switzerland)	Preparation of the site identified to host the project on water pumping; Drilling of a borehole by the State enterprise GEOMOC, E.E.; Manufacture of a storage tank with a capacity of 5 cubic metres by the State Enterprise FORJADORA, E.E.. Continuation of studies on economics and end use analysis; Participation at the 11th EC PVSEC in Montreux, Switzerland.
February to March 1993 (In Mozambique)	Field work in a village for the assessment of the role of photovoltaics for rural development in Mozambique; The name of the village is Massaca, located at the district of Boane, province of Maputo.

April to July 1993 (In UK, Denmark and the Republic of Ireland)	Elaboration of a report for transfer of registration from MPhil. to Ph.D. at the University of Northumbria at Newcastle; The transfer has been done successfully; Training on design and installation of PV pumping systems by Grundfos International, Bjerringbro, Denmark; Training on design and use of monitoring systems by Hyperion Ltd., Cork, Republic of Ireland.
August to December 1993 (In Mozambique)	Design of a PV pumping system for the project; Acquisition of a 848 W <sub>p</sub> PV pumping system from Grundfos International and its installation. Continuation of field work in a village.
February to March 1994 (In Mozambique)	Continuation of studies on monitoring systems and monitoring data analysis.
April to July 1994 (In The Netherlands and UK)	Participation at the 12th EC PVSEC, with presentation of a paper; Writing up of the first two chapters of the Ph.D. dissertation, namely the introduction and the review of solar cells technologies at the University of Northumbria at Newcastle.
August to December 1994 (In Mozambique)	Integration of the monitoring system into the PV pumping plant; Recording and analysis of preliminary data.
January to June 1995 (In Mozambique)	Monitoring of the PV pumping plant; Continuation of studies on data analysis, using Excel for Windows spreadsheet.
July to December 1995 (In Mozambique)	Analysis of technical performance of the PV pumping plant; Analysis of its economic performance.
February to April 1996 (In Mozambique)	Writing up of the first draft of the Ph.D. dissertation.
May to August 1996 (In UK)	Final writing of the Ph.D. dissertation and viva examination at the University of Northumbria at Newcastle.

Remark: Apart from the activities here outlined, the author has participated in several meetings on energy issues both in the country and in the framework of SADC co-operation.