

Northumbria Research Link

Citation: Rossiter, Nick and Heather, Michael (2004) Information systems and the theory of categories: is every model an anticipatory system? *International Journal of Computing Anticipatory Systems*, 16. pp. 219-231. ISSN 1373-5411

Published by: Centre for Hyperincursion and Anticipation in Ordered Systems (CHAOS)

URL:

This version was downloaded from Northumbria Research Link:
<https://nrl.northumbria.ac.uk/id/eprint/3732/>

Northumbria University has developed Northumbria Research Link (NRL) to enable users to access the University's research output. Copyright © and moral rights for items on NRL are retained by the individual author(s) and/or other copyright owners. Single copies of full items can be reproduced, displayed or performed, and given to third parties in any format or medium for personal research or study, educational, or not-for-profit purposes without prior permission or charge, provided the authors, title and full bibliographic details are given, as well as a hyperlink and/or URL to the original metadata page. The content must not be changed in any way. Full items must not be sold commercially in any format or medium without formal permission of the copyright holder. The full policy is available online: <http://nrl.northumbria.ac.uk/policies.html>

This document may differ from the final, published version of the research and has been made available online in accordance with publisher policies. To read and/or cite from the published version of the research, please visit the publisher's website (a subscription may be required.)

Northumbria Research Link

Information Systems and the Theory of Categories: Is Every Model an Anticipatory System?

M. A. Heather*, B. N. Rossiter**

*Sutherland Building, University of Northumbria at Newcastle NE1 8ST, UK,
m.heather@unn.ac.uk

**School of Informatics, University of Northumbria at Newcastle
nick.rossiter@unn.ac.uk

Abstract The possible unknown behaviour of a reactive system may not be fully understood but it may be modelled in an information system. The relationship between a system and its model can be constructed through a series of stages showing the correlation between arrows in the system and in the model. Such a diagram is formal where the system and the model are 2-cell categories and the mappings between the system and the model are adjunctions. Such mappings can be built up using basic arrow constructions or given in a more abstract form in terms of freeness and co-freeness. The adequacy of a model as a representation of a natural system is discussed in terms of mapping properties such as reflection, isomorphism and adjoint equivalence. The circumstances for the model being anticipatory are considered.

Keywords : anticipatory systems, natural system, model, adjointness, freeness.

1 Introduction

In this paper we look closely at modelling relations, in particular the properties of the relationship between a natural system and its representation in terms of a model. These properties are the essence of many subjects such as business process design, systems analysis and information systems development. In addition such relationships have proved to be an essential feature in anticipatory systems – the construction of systems which are tentatively defined as those for which the present behaviour is based on past and/ or present events but also on future events built from these past, present and future events [2]. An incursive system is more than just a recursive one. An incursive discrete system is a system which computes its current state at a particular time, as a function of its states at past times, present time and even its states at future time. A hyperincursive discrete anticipatory system is an incursive discrete anticipatory system generating multiple iterates at each time step. Incursion corresponds to weak anticipation and hyperincursion to strong anticipation. Dubois [3] developed the use of differential difference equation systems,

also called functional differential equations, for describing computing anticipatory systems. To summarise some definitions are given below:

<p>Definitions of recursion, incursion and hyperincursion</p> <p>recursion $x(t + 1) = f(x(t))$</p> <p>incursion $x(t) = f[(x(t + 1), p)]$</p> <p>hyperincursion $x(t + 1) = 1/2 + - 1/2\sqrt{1 - x(t)}$</p> <p>where $x(t)$ is an iterate at time t, p is a parameter</p>
--

There are some differences over whether anticipatory systems are restricted to live systems in the biological sense or may be applied to any system including purely physical ones. Rosen [10] thought that all anticipatory systems were living ones but in reply to the question "Now, all anticipatory systems are living systems, is this true?" in an interview [12] replied cautiously "Well, all that we know about". Dubois [2] considered that anticipation is not only a property of biosystems but is also a fundamental property of physical systems. This debate will be considered in future work. There is also the question of time. Incursion is a recursive model usually expressed in terms of time ¹ but is not necessarily temporal but is still predictive in a 'non-local' sense. Building time into a model may make it local in its scope rather than non-local,

The purpose of the paper is to examine the nature of the relationship between a natural system and a model and to attempt to provide some guidelines on the adequacy of a model and on when the model may be considered as anticipatory. The concept of adjointness in the theory of categories will be used extensively to define properties of the relationship in a formal manner.

1.1 Modelling Relations Informally

Two particular developments in the last half of the twentieth century have helped to provide recursive tools to relate very different concepts like models and systems. One is the concept advanced by Rosen of the anticipatory system. The other is the formal development of the theory of categories. Robert Rosen introduced anticipatory systems in 1985 [9]. At this stage he mainly dealt with physical systems but in 1991 [10] and in 1999 [13] he moved onto natural systems for which he advocates the use of the theory of categories to describe entailment. Rosen had been inspired by the graduate teaching of Sammy Eilenberg [11], one of the pioneers of this theory. Category theory was developed in pure mathematics with few applications except to pure mathematics itself, theoretical computing science and theoretical physics. Rosen developed some interesting pictorial notions for representing relationships as in Figure 1.

¹As Leydesdorff [7] points out from the definition of incursion proposed by Dubois that "An incursive system can be expected to develop recursively along the time axis" (p. 272).

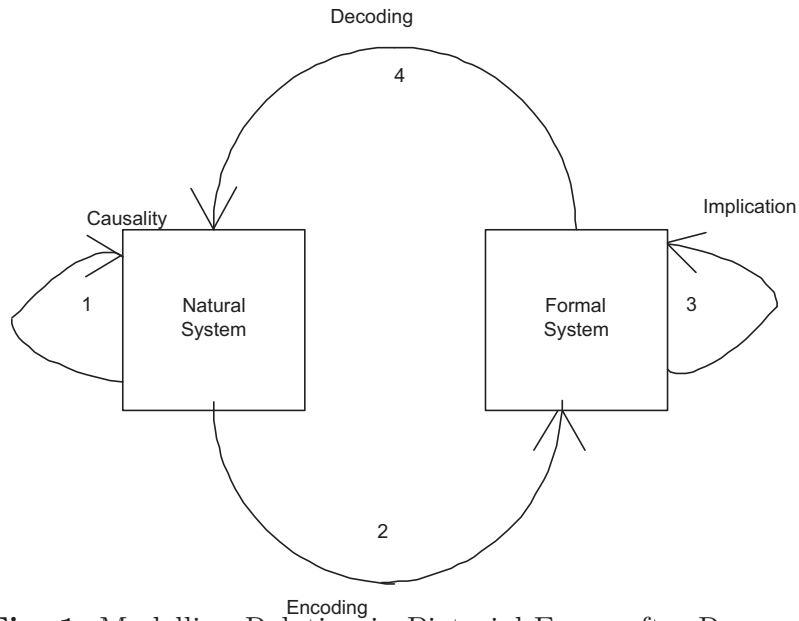

Fig. 1: Modelling Relation in Pictorial Form, after Rosen

Figure 1, adapted from Rosen ([10] Figure 7F.1; [9] Figure 2.3.1 p.74), represents the modelling relation in a pictorial form. The figure shows two systems, a natural system and a formal system related by a set of arrows depicting processes and/or mappings. The natural system is the system that we are trying to understand and the formal system is its attempted model. Encoding implies observation and measurement, decoding implies prediction. The arrows are numbered 1,2,3,4. If the formal system is a satisfactory representation of the natural system, then the result from applying arrow 1 alone should equal that from applying in turn arrow 3 to the output from arrow 2 and arrow 4 to the output from arrow 3. In an early use of diagrammatic equations Rosen [10] observed that "When this is true, we say that the diagram commutes and that we have produced a model of our world". Mikulecky [8] has also developed a version of the same Rosen diagram. His arrow 3 is in the opposite direction to Rosen's so that commutation does not strictly apply. Figure 1 will be developed in this paper to present a more formal interpretation in category theory [5, 6].

2 Reactive Systems as Subcategory of Information Systems

Another perspective on the nature of modelling is shown in Figure 2. A feature of the system may be a state, an action, a process, a property, indeed anything the system is or does. Outside of category theory any of these are usually represented by a set, that is with unordered elements or with some imposed order like a vector or tuple. The ordering is independent of the notion of a set. In category theory any

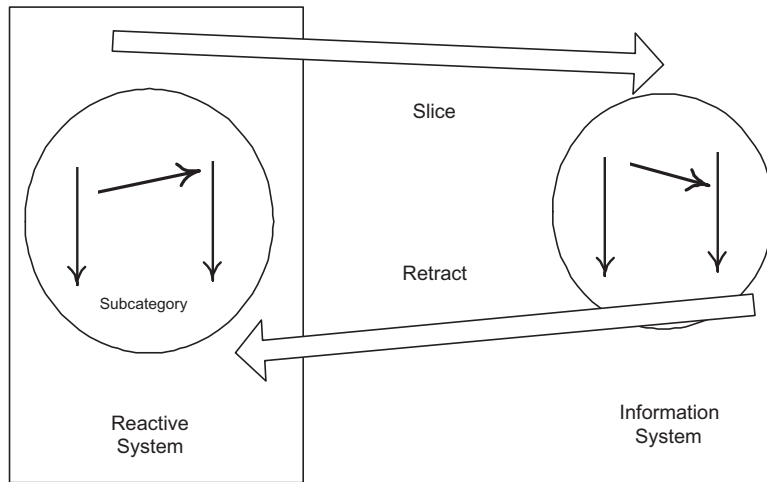

Fig. 2: Reactive System as Subcategory of Information System

feature of a system is an example of the arrow. The direction of the arrow already includes the notion of ordering and also has inherent typing so that a feature of a system is naturally distinguishable.

In the upper limiting case the universe is a reactive system and the information system belongs to it, that is a subcategory. Any other existing reactive system is also a subcategory of the universe as a topos. The nature of the relationship between the reactive system and the information system is given by the slice and retraction. These are considered next in more detail in terms of the adjointness between freeness and co-freeness.

3 Modelling Relations Formally as Adjunctions

For a rigorous explanation of adjointness it is necessary to start with the concept of an arrow.

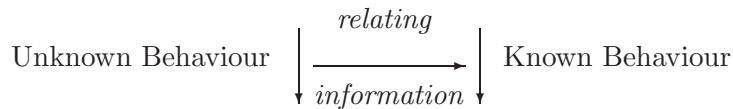

Fig. 3: Arrow relating behaviour: unknown to known

The very simple diagram in Figure 3 immediately shows the use of the arrow to represent concepts like the nature of behaviour and of information passing. It also shows up differences in type. The theory of categories allows a formal theory of

these concepts to be developed rigorously. It is better to formalise Figure 3 in the theory of categories. The concept of the arrow is utilised as a fundamental formal component, in this context, a component of understanding. Therefore arrows in an unknown can be understood by relating them to arrows in the known. Furthermore the relating information can itself be expressed in the same arrow language. The theory of categories is formal in the sense that algebra, topology and geometry are formal and indeed even more so because it subsumes all three. An arrow cannot be free-standing but needs a domain (source) and codomain (target). Where the domain and codomain are indistinguishable the arrow just identifies the existence of such a domain-codomain: \mathbb{Y}

This arrow \mathbb{Y} has no name until it needs to be distinguished² as an identity arrow is the simplest type of arrow. The domain-codomain it identifies is commonly given the label *object* in texts on category theory. However it is always an arrow even though it may describe a set-type object. But the type of an object depends not just on the intrinsic domain-codomain of its identifying arrow but on the relationships one with another. Identity is a nullary operator and an object as an identity arrow is a nullary operation. If an identity arrow is to be distinguished from others, it can be given a label informally like 1_A or 1_B . Formally the distinguishing is by an arrow:

$$\mathbb{Y}1_A \longrightarrow \mathbb{Y}1_B$$

This is then usually simplified to objects A and B .

$$\mathbb{Y}A \longrightarrow \mathbb{Y}B$$

This then is a different type of arrow from the identity arrow because it is relating distinguishable identity arrows (objects). The formal version of indistinguishability is isomorphism [14]. A category is a collection of two types of arrow: 1) identity arrows and 2) arrows relating one identity arrow to another identity arrow.

A functor is itself an arrow which maps arrows between categories. A reactive system consists of arrows (processes) in a category \mathbf{S} . A model is an information system consisting of processes in category \mathbf{A} where there is some correlation between the processes such that the arrows of \mathbf{A} provide information on the arrows of \mathbf{S} . In a sense even if we only have access to \mathbf{A} we can still understand to some extent the behaviour of \mathbf{S} . However mutual functors $F : \mathbf{S} \longrightarrow \mathbf{A}$ and $G : \mathbf{A} \longrightarrow \mathbf{S}$ mapping between \mathbf{S} and \mathbf{A} will not necessarily map between the same arrows. However by the principle of adjunction there will be at most one functor F which naturally composes with G in the manner conventionally written as $F \dashv G$ where F is the free functor and G the co-free (underlying) functor.

²The active distinguishing comes from a higher order and in religion this is the cause of why God's name is not known because as a matter of logic there can be no one higher to name him, her or it.

Turning to the nature of the relationship between a natural system and its model, a system arrow $S \rightarrow S'$ relates objects or entities of the system as a category where S, S' are distinguishable labels. A model will have arrows A', A . There is a difference in type between arrows in the system and the model. System arrows are ontological, model arrows are epistemological. It will be seen below how this distinction emerges naturally ³. As before G is a functor which formally defines the relation between a model and the system it models. Therefore G is given for a system when a particular model is described (i.e. selected). We need to investigate the conjugate functor F to see how S determines A which is fundamental to the idea of modelling.

Figure 4 shows a typical arrow on the left (f in S) which is a family of arrows that correlates with a family of arrows in A which are represented in the figure by a typical right hand arrow $f^\#$. Correlation under adjunction is given by

$$\frac{1_S \leq GF}{FG \leq 1_A}$$

The double bar indicates inference and its converse. GF is the functorial composition of applying functor G to the result of applying functor F to category S . FG is the corresponding application of functor F to the result of applying functor G to category A . The symbol \leq is the usual reflexive transitive ordering.

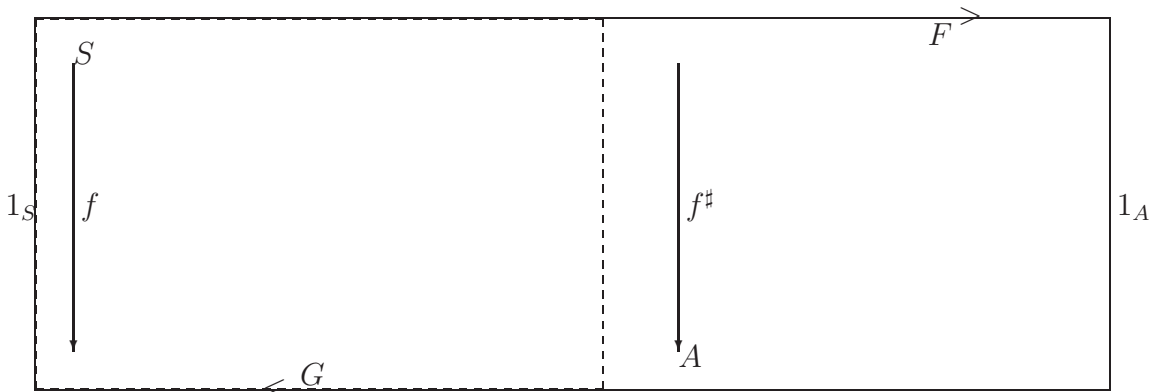

Fig. 4: Correlation between Arrow f in S and $f^\#$ in A

The unit of adjunction is $\eta : 1_S \rightarrow GF$ and the counit is $\epsilon : FG \rightarrow 1_A$. If $\eta = 0$ GF returns the arrow f to its original state f . That is F maps object S to $F(S)$ as G maps A to $G(A)$ as in Figure 5. If η is greater than 0 functor G will take $F(S)$ to a different object in S . So we have $\eta : S \rightarrow GF(S)$ in Figure 6. Note the distinction

³Here the primed S' is used for a system arrow target and A' for a model arrow source because it makes plainer the antisymmetric situation.

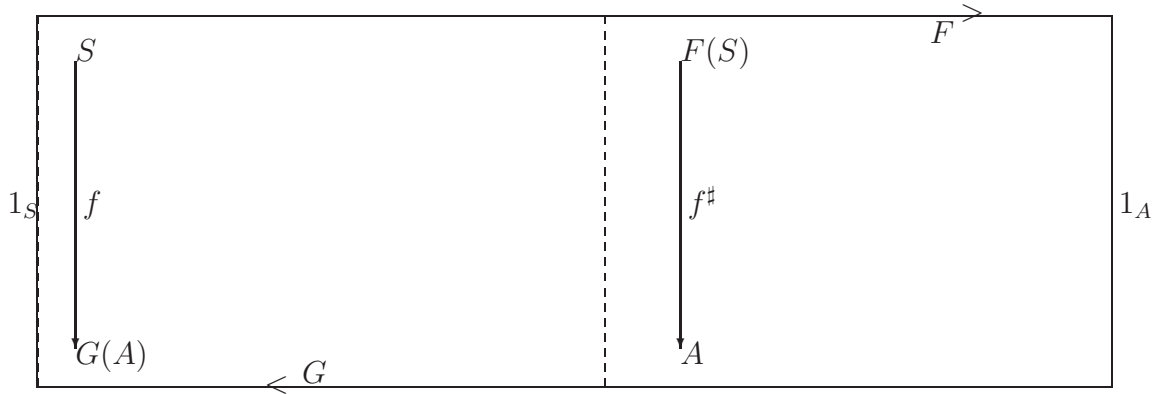

Fig. 5: Correlation between Arrow f in \mathbf{S} and f^\sharp in \mathbf{A} where $\eta = 0$

shown in Figure 7 of f^\sharp under functor G as the arrow $GF(S) \rightarrow G(A)$ labelled $G(f^\sharp)$. Because of the uniqueness of adjunction there will be only one possible arrow $G(f^\sharp)$ given by the composition of the triangle shown in Figure 8.

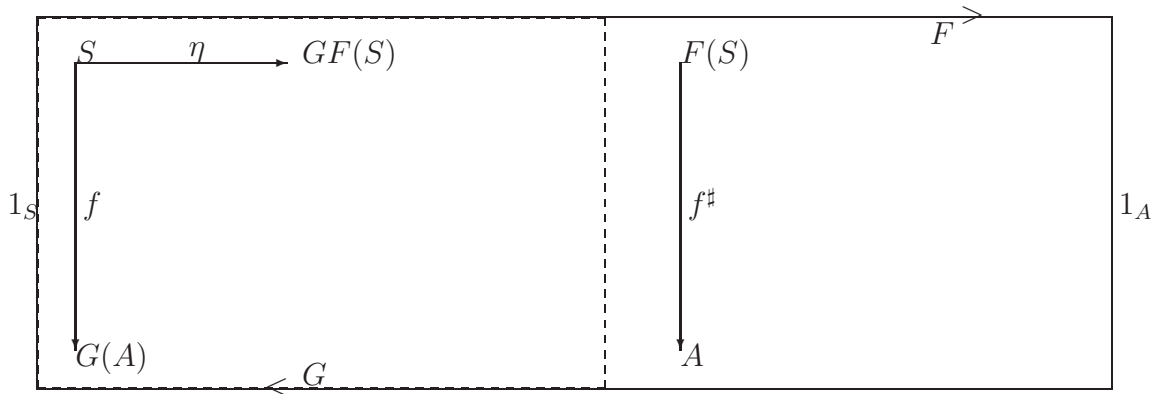

Fig. 6: Correlation between Arrow f in \mathbf{S} and f^\sharp in \mathbf{A} where $\eta > 0$

Figure 7 is the explanation of naturality⁴. What happens to the arrow whose source object is $GF(S)$? In this case we have the dual perspective, representing co-freeness as shown in the following Figures 9 to 11. If $\epsilon = 1$, FG returns the arrow f^\sharp to its original state f^\sharp . If ϵ is less than 1, functor F will take $G(A)$ to a different object in \mathbf{A} . So we have $\epsilon : FG(A) \rightarrow A$ as in Figure 9. Note the distinction in Figure 10 of f under functor F as the arrow $F(S) \rightarrow FG(A)$ labelled $F(f)$. In Figure 11 we introduce the correlation between an arrow g in \mathbf{A} and g^\flat in \mathbf{S} .

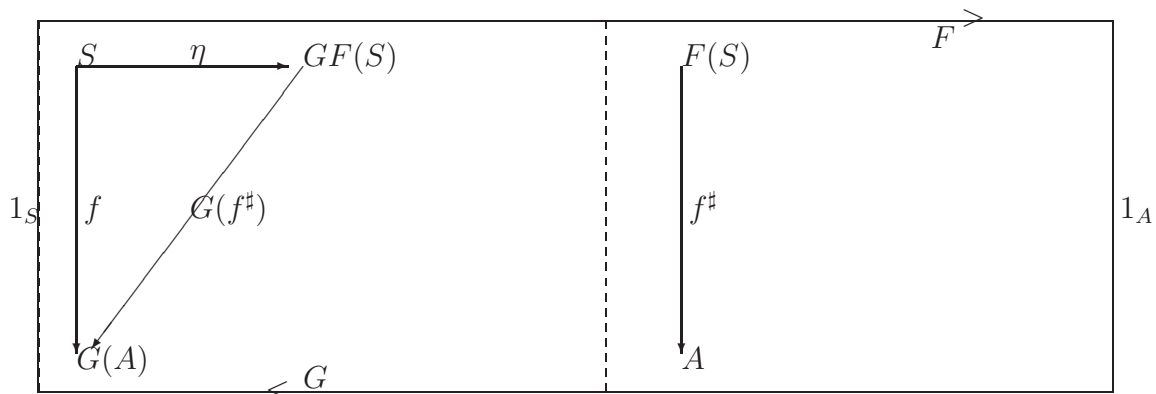

Fig. 7: Distinction of $f^\#$ in \mathbf{S} by arrow $G(f^\#)$

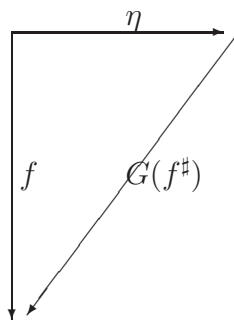

Fig. 8: Uniqueness of adjunction: only one possible arrow $G(f^\#)$

In Figure 12 we show the mappings that occur in correlating g in \mathbf{A} with g^b in \mathbf{S} where $\eta > 0$ and $\epsilon < 1$. The complete picture of the adjointness is given in Figure 13 to illustrate all the relevant mappings between an arrow f in \mathbf{A} and another arrow g in \mathbf{S} where $\eta > 0$ and $\epsilon < 1$.

Figures 4 to 13 show in detail the nature of adjointness, in a manner perhaps more suited to implementation in a computer system than is the normal approach with category theory in mathematics where abstraction is usually preferred. The build up is from arrows in \mathbf{S} to correlating arrows in \mathbf{A} for representing the freeness associated with the free functor F . The co-free functor G is the underlying functor which we shall see later is critical in establishing how well \mathbf{S} reflects \mathbf{A} . A more abstract representation (extending that in [4]) is shown in Figures 14 to 16. Figure 14 corresponds to Figure 5 where the unit of adjunction η is 0, giving a simple equivalence between the two categories \mathbf{A} and \mathbf{S} . Figure 15 corresponds to Figure 7 where the unit of adjunction η is greater than 0 with η taking S to a different object $GF(S)$. Figure 16 corresponds to Figure 10 where the counit of adjunction ϵ is less than 1 with ϵ taking $FG(A)$ to a different object A .

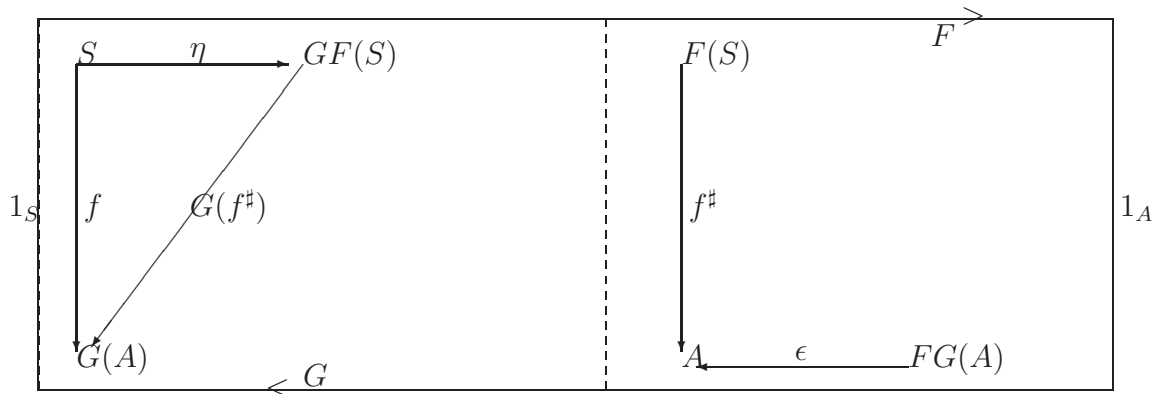

Fig. 9: Correlation between Arrow f in \mathbf{S} and $f^\#$ in \mathbf{A} where $\epsilon < 1$

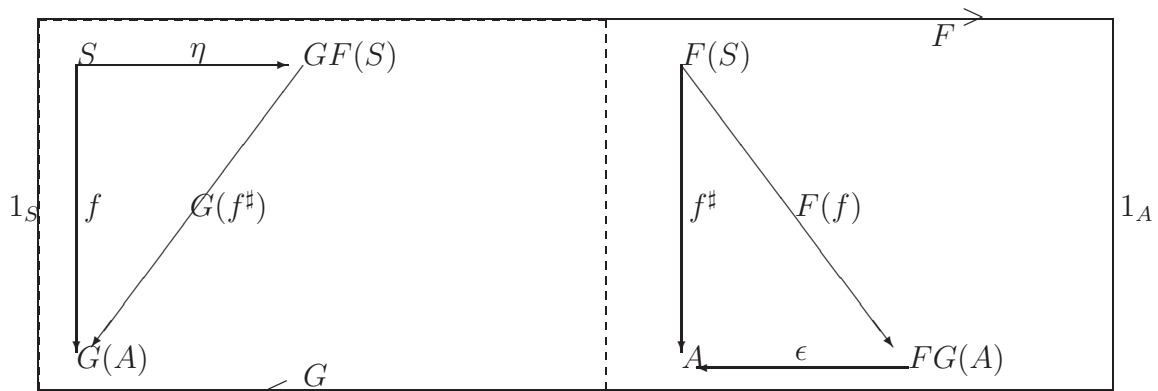

Fig. 10: Distinction of f in \mathbf{A} by arrow $F(f)$

4 Implications for Anticipation

The adequacy of the model is the first important consideration. A model should be a satisfactory representation of a natural system if it is to be appropriate for predictive purposes. It therefore appears to be necessary for the natural system and the model to be in a state of adjointness as represented in Figures 13, 15 and 16. This is the minimum requirement for a model to be said to be a fair representation of a system. The minimum relationship in which we are interested is therefore *adjoint equivalence* ([6] p.26) defined as the 4-tuple $\langle F, G, \eta, \epsilon \rangle$ where F, G are functors, η is the unit of adjunction and ϵ the counit of adjunction as developed in detail earlier.

Stronger correlations like reflection, equivalence or isomorphism would clearly make the correspondence stronger. We now look at a number of mapping properties

⁴Although not justified here this naturality is defined in the companion paper [14].

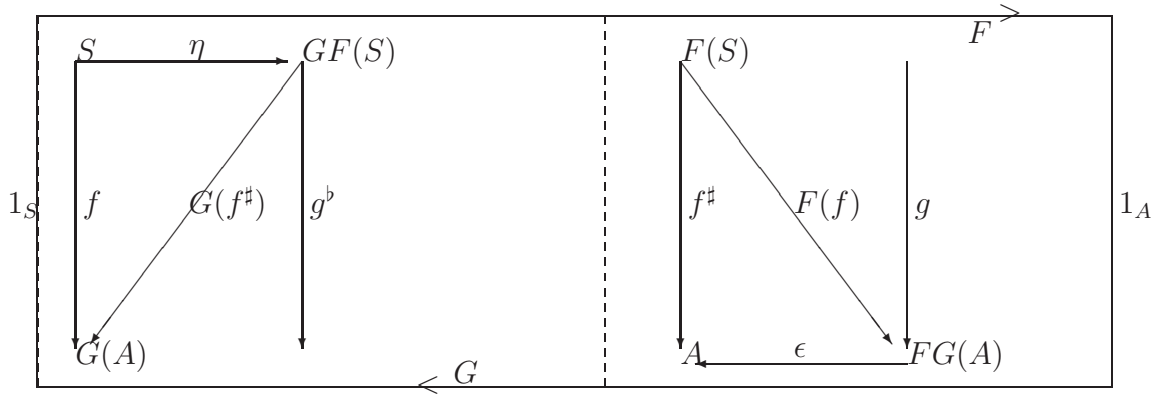

Fig. 11: Correlation between Arrow g in \mathbf{A} and g^b in \mathbf{S}

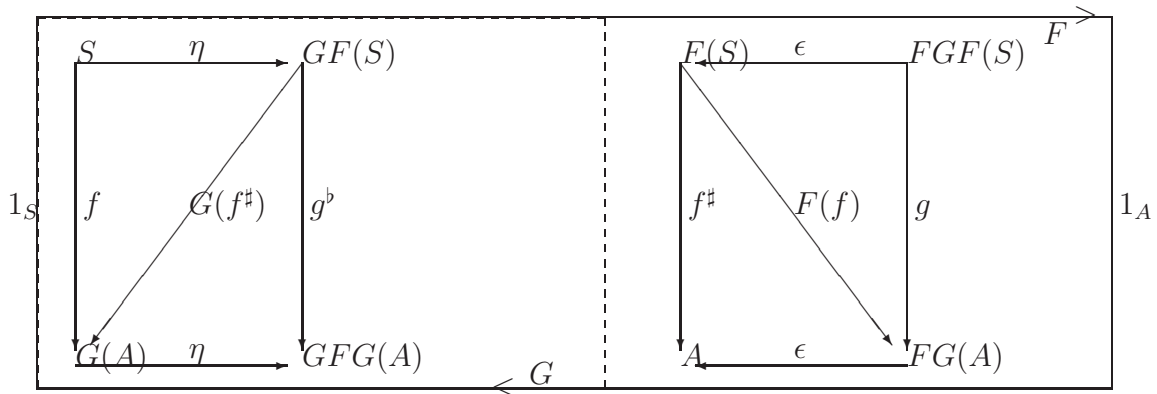

Fig. 12: Correlation between Arrow g in \mathbf{A} and g^b in \mathbf{S} where $\eta > 0$ and $\epsilon < 1$

to see what can be said under different circumstances. As before \mathbf{S} is a natural system and \mathbf{A} is its model.

The terminology for the mapping properties varies from one author to another. Using that of Bell ([1] p. 21), a functor $F : \mathbf{S} \rightarrow \mathbf{A}$ is *full* if for each pair (S, S') of objects in \mathbf{S} , F carries $\mathbf{S}(S, S')$ onto $\mathbf{A}(A', A)$. The dual G is therefore *full* if for each pair (A', A) of objects in \mathbf{A} , G carries $\mathbf{A}(A', A)$ onto $\mathbf{S}(S, S')$. Further a functor $F : \mathbf{S} \rightarrow \mathbf{A}$ is *faithful* if for each pair (S, S') of objects in \mathbf{S} , F is one-to-one on $\mathbf{S}(S, S')$ objects. The dual functor $G : \mathbf{A} \rightarrow \mathbf{S}$ is *faithful* if for each pair (A', A) of objects in \mathbf{A} , G is one-to-one on $\mathbf{A}(A', A)$ objects. A full and faithful functor is both monic and epic, corresponding approximately to injective and surjective respectively in terms of set theory.

Johnstone ([5] 1 p.1 A.1.1) deals with the mappings from a more arrow-based perspective. He defines a functor as *full* if its inclusion functor is full and *faithful* if the functor is injective on hom-sets⁵, that is for a functor $F : \mathbf{A} \rightarrow \mathbf{S}$ with objects $\mathbf{A}(A', A)$:

$$(F(A') = F(A)) \quad \Rightarrow \quad (A' = A)$$

⁵A hom-set is a collection of arrows, in a category in this case.

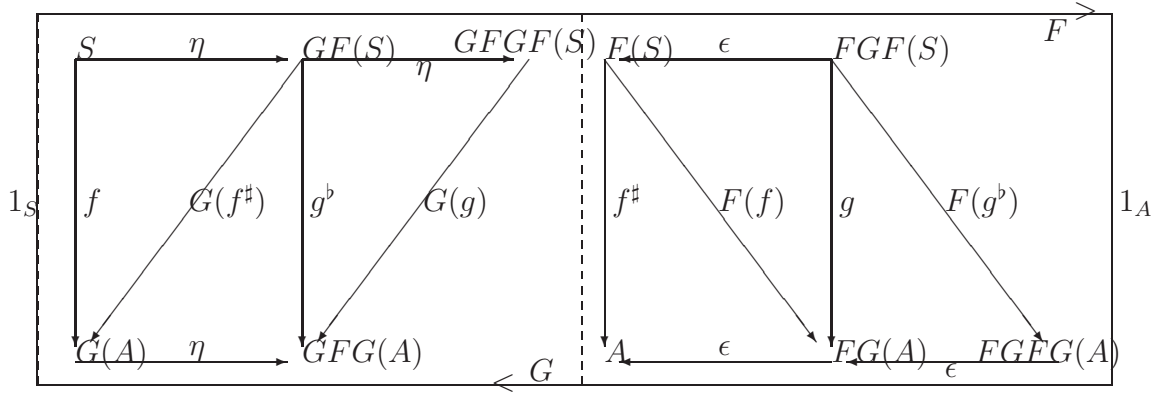

Fig. 13: Complete Picture: Correlation between η and ϵ in 2-cell Adjunction $F \dashv G$

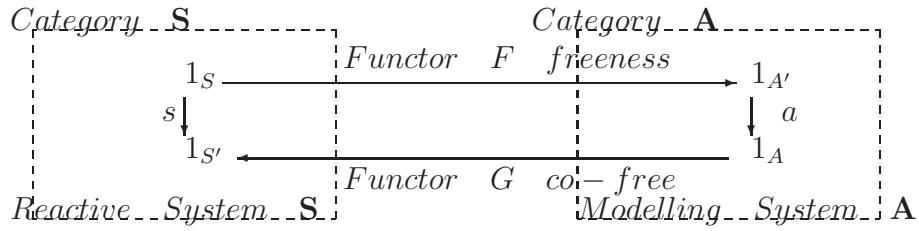

Fig. 14: Nature of Modelling Systems: $\eta = 0$ and $\epsilon = 1$

A functor that is both full and faithful is considered to be isomorphic. The inclusion functor for a subcategory is full and faithful. If both F and G are inclusion functors, then the two categories \mathbf{S} and \mathbf{A} would be indistinguishable, that is isomorphic. In this case the modelling process generating \mathbf{A} can be said to have been perfect.

If it is not possible to say that F or G are both full and faithful, then the model \mathbf{A} will be partial in some respect as described below.

F is full but not faithful: if F is full then all the arrows in \mathbf{S} are mapped to \mathbf{A} so that the model is complete in its coverage. However through not being faithful, the model may be imprecise in that it may contain additional arrows of its own to those assigned by F and it will not have a one-to-one correspondence with features in the natural system.

G is full but not faithful: If G is full then all the arrows in \mathbf{A} are mapped to \mathbf{S} so that all concepts in the model are relevant to the natural system. However through not being faithful, the model may be imprecise in that the system may contain additional features of its own to those assigned by G and it will not have a one-to-one correspondence with concepts in the model.

F is not full but is faithful: if F is not full then not all the arrows in \mathbf{S} are mapped to \mathbf{A} so that the model is incomplete in its coverage. However through being faithful, the model is precise in what it covers in that each feature of the natural system assigned by F will be in a one-to-one correspondence with concepts in the model.

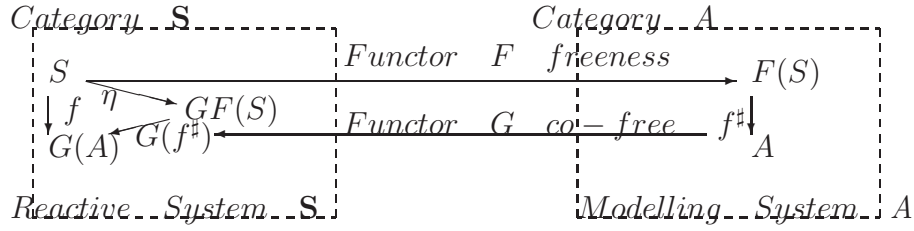

Fig. 15: Nature of Modelling Systems: unit of adjunction $\eta > 0$

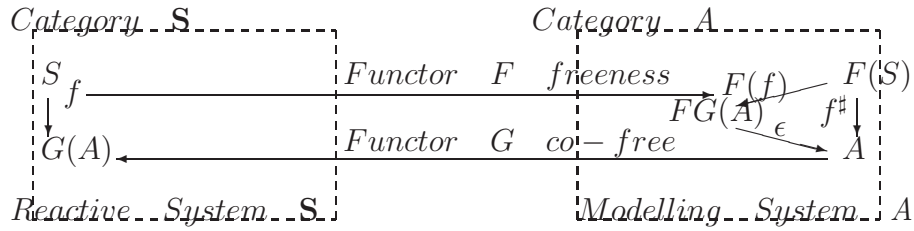

Fig. 16: Nature of Modelling Systems: counit of adjunction $\epsilon < 1$

G is not full but is faithful: if G is not full then not all the arrows in \mathbf{A} are mapped to \mathbf{S} so that the model's coverage is greater than that needed for the natural system. However through being faithful, the model is precise in what it covers in that each concept assigned by G will be in a one-to-one correspondence with features of the system.

If F or G are neither full nor faithful, then the model will be an even less precise representation of the system as can be deduced from inspection of the above. However, it needs to be recognised that modelling of complex systems is very difficult and a relationship of adjoint equivalence, as developed earlier, may still be very useful and indeed may be the only one achievable in many cases.

For \mathbf{A} to be an anticipatory system, it will first need to be predictive. This implies that the left adjoint functor F must be full so that all features of the natural system are present in the model. If F were faithful this would imply a one-to-one relationship between the system and the model, corresponding to incursion. If F were not faithful and the unit of adjunction η is greater than 0, implying creativity, then this would correspond to hyperincursion.

The right-adjoint functor G also needs to be considered. If this were full then all concepts in the model are assigned to the natural system. If this were faithful then there would be a one-to-one correspondence between concepts in the model and features in the natural system. None seem to be needed for \mathbf{A} to be an anticipatory system. However there does need to be a right adjoint for a rigorous two-way mapping to be maintained between the natural system and its model.

The conclusion is that a model is an anticipatory system if it is in adjoint equivalence with the natural system and the left adjoint functor (from system to model) is full. The model gives incursion if the left adjoint functor is faithful and hyperin-

curtion if the unit of adjunction is greater than zero.

References

- [1] Bell, J L, *Toposes and Local Set Theories: An Introduction*, Oxford Logic guides **14** (1988).
- [2] Dubois, Daniel M, Review of Incursive, Hyperincursive and Anticipatory Systems - Foundation of Anticipation in Electromagnetism. *Computing Anticipatory Systems: CASYS'99 - Third International Conference* Edited by Daniel M. Dubois, AIP Conference Proceedings **517** 3-30 (2000).
- [3] Dubois, Daniel M, Theory of Computing Anticipatory Systems Based on Differential Delayed-Advanced Difference Equations. *Computing Anticipatory Systems : CASYS 2001 - Fifth International Conference* edited by D. M. Dubois, AIP CP **627** 3-16 (2002).
- [4] Heather, M A, & Rossiter, B N, Locality, Weak or Strong Anticipation and Quantum Computing I. Non-locality in Quantum Theory, *International Journal Computing Anticipatory Systems* **13** 307-326 (2002).
- [5] Johnstone, P T, Sketches of an Elephant, A Topos Theory Compendium, *Oxford Logic Guides* 43, Clarendon (2002).
- [6] Leinster, Tom, *Higher Operads, Higher Categories*, Cambridge (2004).
- [7] Leydesdorff, Loet, The Construction and Globalization of the Knowledge Base in Inter-human Communication System, *Canadian Journal of Communication* **28**(3) 267-289 (2003).
- [8] Mikulecky, D C, *Robert Rosen: the well-posed question and its answer. Why are organisms different from machines?* <http://www.people.vcu.edu/~mikuleck/PPRISS3.html> (consulted August, 2004).
- [9] Rosen, Robert, *Anticipatory Systems, Philosophical, Mathematical and Methodological Foundations* Pergamon (1985).
- [10] Rosen, R, *Life Itself, A Comprehensive Inquiry into the Nature, Origin, and Fabrication of Life* Columbia University Press, New York (1991).
- [11] Rosen, Robert, *Autobiographical Reminiscence*, written c1992, <http://www.rosen-enterprises.com/Dad/RRosenautobio.doc> (consulted, 2004).
- [12] Rosen, Robert, *Transcript of a Videotaped Interview* July, 1997, Rochester, New York, by Judith Rosen <http://www.people.vcu.edu/~mikuleck/rsntpe.html> (1997).
- [13] Rosen, R, *Essays on Life Itself* Columbia University Press, New York (1999).
- [14] Rossiter, B Nick, & Heather, M A, Data Structures in Natural Computing: Databases as Weak or Strong Anticipatory Systems, *CASYS'03, Sixth International Conference on Computing Anticipatory Systems* Liège, Belgium, AIP Conference Proceedings **718** 392-405 (2004).